

Quantum Field Theory¹

Roberto Casalbuoni

Dipartimento di Fisica

Università di Firenze

¹Lectures given at the Geneva University during the academic year 1997/98.

Contents

Index	1
1 Introduction	3
1.1 Major steps in quantum field theory	3
1.2 Many degrees of freedom	4
1.3 Linear atomic string	5
2 Lagrangian formalism for continuum systems and quantization	11
2.1 String quantization	11
2.2 The lagrangian formalism for continuum systems	15
2.3 The canonical quantization of a continuum system	19
3 The Klein-Gordon field	25
3.1 Relativistic quantum mechanics and its problems	25
3.2 Quantization of the Klein-Gordon field	28
3.3 The Noether's theorem for relativistic fields	34
3.4 Energy and momentum of the Klein-Gordon field	38
3.5 Locality and causality in field theory	41
3.6 The charged scalar field	46
4 The Dirac field	51
4.1 The Dirac equation	51
4.2 Covariance properties of the Dirac equation	54
4.3 Free particle solutions of the Dirac equation	59
4.4 Wave packets and negative energy solutions	65
4.5 Electromagnetic interaction of a relativistic point-like particle	67
4.6 Non relativistic limit of the Dirac equation	73
4.7 Charge conjugation, time reversal and PCT transformation	76
4.8 Dirac field quantization	81
5 The electromagnetic field	89
5.1 The quantization of the electromagnetic field	89

6	Symmetries in field theories	101
6.1	The linear σ -model	101
6.2	Spontaneous symmetry breaking	107
6.3	The Goldstone theorem	111
6.4	QED as a gauge theory	113
6.5	Non-abelian gauge theories	115
6.6	The Higgs mechanism	119
7	Time ordered products	125
7.1	Time ordered products and propagators.	125
7.2	A physical application of the propagators	131
8	Perturbation theory	136
8.1	The electromagnetic interaction	136
8.2	The scattering matrix	138
8.3	The Wick's theorem	146
8.4	Evaluation of the S matrix at second order in QED	149
8.5	Feynman diagrams in momentum space	157
9	Applications	164
9.1	The cross-section	164
9.2	The scattering $e^+e^- \rightarrow \mu^+\mu^-$	166
9.3	Coulomb scattering	171
10	One-loop renormalization	175
10.1	Divergences of the Feynman integrals	175
10.2	Dimensional regularization of the Feynman integrals	183
10.3	Integration in arbitrary dimensions	184
10.4	One loop regularization of QED	187
10.5	One loop renormalization	193
10.6	Lamb shift and $g - 2$	198

Chapter 1

Introduction

1.1 Major steps in quantum field theory

1924 Bose and Einstein introduce a new statistics for light-quanta (photons).

1925

- January - Pauli formulates the exclusion principle.
- July - Heisenberg's first paper on quantum mechanics (matrix mechanics).
- September - Born and Jordan extend Heisenberg's formulation of quantum mechanics to electrodynamics.

1926

- January - Schrödinger writes down the wave equation.
- February - Fermi introduces a new statistics (Fermi-Dirac).
- August - Dirac relates statistics and symmetry properties of the wave function, and shows that the quantized electromagnetic field is equivalent to a set of harmonic oscillators satisfying the Bose-Einstein statistics.

1927

- March - Davisson and Germer detect the electron diffraction by a crystal.
- October - Jordan and Klein show that quantum fields satisfy commutation rules.

1928

- January - The Dirac equation.
- January - Jordan and Wigner introduce anticommuting fields for describing particles satisfying Fermi-Dirac statistics.

- January - Pauli and Heisenberg develop the analog for fields of the Lagrangian and Hamiltonian methods of mechanics.
- Klein and Nishina complete the theory of the scattering Compton based on the Dirac equation.

1929

- March - Weyl formulates gauge invariance and its relation to charge conservation.
- December - Dirac introduces the notion of hole theory, identifying a hole with a proton.

1931 Dirac proposes the positron to interpret the energy negative solutions of his equation and Heisenberg introduces the idea of antiparticles.

1932 Anderson detects the positron.

1934 Dirac and Heisenberg evaluate the vacuum polarization of the photon. First battle with infinities in quantum field theory.

1936 Serber introduces the concept of renormalized charge.

1947 Bethe evaluates the Lamb-shift.

1948 Schwinger ends the calculation of the Lamb-shift and the renormalization program starts.

1.2 Many degrees of freedom

Aim of this course is to extend ordinary quantum mechanics, which describes non relativistic particles in interaction with given forces, to the relativistic case where forces are described by fields, as for the electromagnetic case. The most relevant differences between the two cases are that the forces become dynamical degrees of freedom, and that one needs a relativistic treatment of the problem. In order to get a consistent description we will need to quantize the field degrees of freedom.

The concept of field is a very general one. A field represents a physical quantity depending on the space-time point. Examples are the distribution of temperatures in a room, the distribution of the pressure in the atmosphere, the particle velocities inside a fluid, the electric and magnetic fields in a given region of space. The common physical feature of these systems is the existence of a fundamental state, for example:

- pressure or temperature \implies state with $T = \text{constant}$, or $P = \text{constant}$
- particle velocities in a fluid \implies state at rest
- electromagnetic field \implies state of vacuum.

In most of these cases one is interested in discussing small deviations of the system from the fundamental state. By doing so one gets, in a first approximation, linear equations for the fields (these being defined in terms of the deviations). One can then improve the situation by adding small corrections and treating the problem through some perturbative approximation. This linear approximation is generally very similar for many different physical situations. For instance, in many cases one gets the wave equation. The quantization of such a system will lead us to describe the system in terms of particles corresponding to the different classical excitations.

The field quantization is done by considering the equation of motion for the field as a hamiltonian system describing an infinite number of degrees of freedom. In order to understand this point we will begin with a very simple system. That is a string of N linear oscillators (for instance a one-dimensional string of atoms) in the limit of $N \rightarrow \infty$ with a separation among the atoms going to zero. In this way we get a vibrating string as the continuum limit.

1.3 Linear atomic string

Let us consider a string of $N + 1$ harmonic oscillators, or $N + 1$ atoms (of unit mass) interacting through a harmonic force, as in Fig. (1.1). The length of the string is L

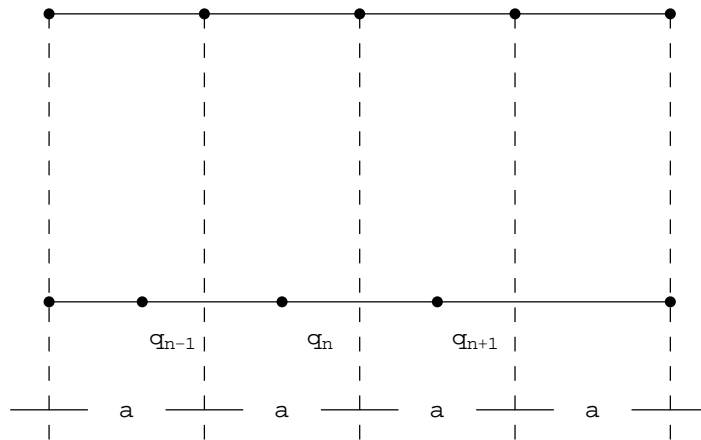

Fig. 1.1 - In the upper line the atoms are in their equilibrium position, whereas in the lower line they are displaced by the quantities q_n .

and the inter-atomic distance is a . Therefore $L = Na$. The equations of motion are the following

$$\ddot{q}_n = \omega^2 [(q_{n+1} - q_n) + (q_{n-1} - q_n)] = \omega^2 [q_{n+1} + q_{n-1} - 2q_n] \quad (1.1)$$

as it follows immediately from the expression of the potential energy of the system

$$U = \frac{1}{2}\omega^2 \sum_{n=1}^N (q_n - q_{n+1})^2 \quad (1.2)$$

In order to define the problem one has to specify the boundary conditions, although in the $N \rightarrow \infty$ limit we do not expect that they play any role. Usually one considers two possible boundary conditions

- Periodic boundary conditions, that is $q_{N+1} = q_1$.
- Fixed boundary conditions, that is $q_{N+1} = q_1 = 0$.

To quantize the problem is convenient to go to the hamiltonian formulation. The hamiltonian is given by ($p_n = \dot{q}_n$)

$$H = T + U = \frac{1}{2} \sum_{n=1}^N (p_n^2 + \omega^2 (q_n - q_{n+1})^2) \quad (1.3)$$

The equations of motion can be diagonalized by looking for the eigenmodes. Let us put

$$q_n^{(j)} = A_j e^{ik_j a n} e^{-i\omega_j t} \quad (1.4)$$

where the index j enumerates the possible eigenvalues. Notice that in this equation the dependence on the original equilibrium position has been made explicit through

$$q_n^{(j)} = q^{(j)}(x_n) = q^{(j)}(na) \approx e^{ik_j x_n} \quad (1.5)$$

where $x_n = na$ is the equilibrium position of the n^{th} atom. By substituting eq. (1.4) into the equations of motion we get

$$-\omega_j^2 q_n^{(j)} = -4\omega^2 q_n^{(j)} \sin^2 \left(\frac{k_j a}{2} \right) \quad (1.6)$$

from which

$$\omega_j^2 = 4\omega^2 \sin^2 \left(\frac{k_j a}{2} \right) \quad (1.7)$$

The relation between k_j (wave vector) and ω_j (frequency of oscillation), shown graphically in Fig. (1.2), is called a dispersion relation.

We may notice that wave vectors differing for integer multiples of $2\pi/a$, that is, such that

$$k'_j = k_j + 2m \frac{\pi}{a}, \quad m = \pm 1, \pm 2, \dots \quad (1.8)$$

correspond to the same ω_j . This allows us to restrict k_j to be in the so called first Brillouin zone, that is $|k_j| \leq \pi/a$. Let us now take into account the boundary

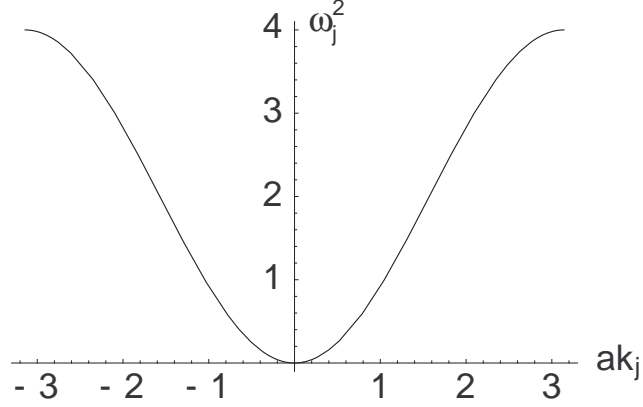

Fig. 1.2 - The first Brillouin zone.

conditions. Here we will choose periodic boundary conditions, that is $q_{N+1} = q_1$, or, more generally, $q_{n+N} = q_n$. This gives us

$$q_{n+N}^{(j)} = A_j e^{ik_j a(n+N)} e^{-i\omega_j t} = q_n^{(j)} = A_j e^{ik_j a n} e^{-i\omega_j t} \quad (1.9)$$

from which

$$k_j a N = 2\pi j \quad (j = \text{integer}) \quad (1.10)$$

Since $aN = L$ (L is the length of the string)

$$k_j = \frac{2\pi}{aN} j = \frac{2\pi}{L} j \quad j = 0, \pm 1, \pm 2, \dots, \pm \frac{N}{2} \quad (1.11)$$

where we have taken N even. The restriction on j follows from considering the first Brillouin zone ($|k_j| \leq \pi/a$). Notice that the possible values of k_j are $2(N/2) + 1 = N + 1$, and that $j = 0$ corresponds to a uniform translation of the string (with zero frequency). Since we are interested only in the oscillatory motions, we will omit this solution in the following. It follows that we have N independent solutions

$$q_n^{(j)} = A_j e^{-i\omega_j t} e^{iak_j n} \quad (1.12)$$

The most general solution is obtained by a linear superposition

$$q_n = \sum_j e^{i\frac{2\pi}{N} j n} \frac{Q_j}{\sqrt{N}} \quad (1.13)$$

$$p_n = \sum_j e^{-i\frac{2\pi}{N} j n} \frac{P_j}{\sqrt{N}} \quad (1.14)$$

From the reality of q_n and p_n we get

$$Q_j^* = Q_{-j}, \quad P_j^* = P_{-j} \quad (1.15)$$

In the following we will make use of the following relation

$$\sum_{n=1}^N e^{i\frac{2\pi}{N}(j'-j)n} = N\delta_{jj'} \quad (1.16)$$

This can be proven by noticing that for $j \neq j'$:

$$\begin{aligned} \sum_{n=1}^N e^{i\frac{2\pi}{N}(j'-j)n} &= \sum_{n=0}^N \left[e^{i\frac{2\pi}{N}(j'-j)} \right]^n - 1 \\ &= \frac{1 - e^{i\frac{2\pi}{N}(j'-j)(N+1)}}{1 - e^{i\frac{2\pi}{N}(j'-j)}} - 1 = 0 \end{aligned} \quad (1.17)$$

whereas for $j = j'$ the sum gives N . By using this equation we can invert the previous expansions

$$\sum_{n=1}^N q_n e^{-i\frac{2\pi}{N}j'n} = \sum_j \sum_n e^{i\frac{2\pi}{N}(j'-j)n} \frac{Q_j}{\sqrt{N}} = \sqrt{N}Q_{j'} \quad (1.18)$$

obtaining

$$Q_j = \frac{1}{\sqrt{N}} \sum_{n=1}^N q_n e^{-i\frac{2\pi}{N}jn} \quad (1.19)$$

$$P_j = \frac{1}{\sqrt{N}} \sum_{n=1}^N p_n e^{i\frac{2\pi}{N}jn} \quad (1.20)$$

Notice that $P_j = \dot{Q}_{-j}$. Substituting inside the hamiltonian we find

$$H = \sum_{j=1}^{N/2} \left(|P_j|^2 + \omega_j^2 |Q_j|^2 \right) \quad (1.21)$$

This is nothing but the hamiltonian of N decoupled harmonic oscillators each having a frequency ω_j , as it can be seen by putting

$$\begin{aligned} P_j &= X_j + iY_j \\ Q_j &= Z_j + iT_j \end{aligned} \quad (1.22)$$

The result we have obtained so far shows that the string of N atoms is equivalent to N decoupled harmonic oscillators. The oscillator modes are obtained through the

expansion of the displacements from the equilibrium condition in normal modes. We are now in the position to introduce the concept of displacement field. Let us define a function of the equilibrium position of the atoms

$$x_n = na, \quad L = Na \quad (1.23)$$

as the displacement of the n^{th} atom from its equilibrium position

$$u(x_n, t) = q_n(t) \quad (1.24)$$

The field $u(x_n, t)$ satisfies the following equation of motion

$$\begin{aligned} \ddot{u}(x_n, t) &= \omega^2 [u(x_{n+1}, t) + u(x_{n-1}, t) - 2u(x_n, t)] \\ &= \omega^2 [(u(x_{n+1}, t) - u(x_n, t)) - (u(x_n, t) - u(x_{n-1}, t))] \end{aligned} \quad (1.25)$$

Let us now consider the continuum limit of this system. Physically this is equivalent to say that we are looking at the system at a scale much bigger than the inter-atomic distance. We will define the limit by taking $a \rightarrow 0$, by keeping fixed the length of the string, that is to say

$$a \rightarrow 0, \quad N \rightarrow \infty, \quad aN = L \quad \text{fisso} \quad (1.26)$$

The quantity $u(x_n, t)$ goes to a function of the variable x defined in the interval $(0, L)$. Furthermore

$$\frac{u(x_n, t) - u(x_{n-1}, t)}{a} \rightarrow u'(x, t) \quad (1.27)$$

and

$$\begin{aligned} (u(x_{n+1}, t) - u(x_n, t)) - (u(x_n, t) - u(x_{n-1}, t)) &\rightarrow a(u'(x_{n+1}, t) - u'(x_n, t)) \\ &\rightarrow a^2 u''(x, t) \end{aligned} \quad (1.28)$$

The equation of motion becomes

$$\ddot{u}(x, t) = a^2 \omega^2 u''(x, t) \quad (1.29)$$

Let us recall that the quantity ω appearing in the equation of motion for the field is the elastic constant divided by the mass of the atom. In order to give a sense to the equation of motion in the previous limit we need that ω diverges in the limit. One could say that in order the string has a finite mass in the continuum, the mass of each atom must go to zero. That is, we will require

$$\lim_{a \rightarrow 0} a\omega = v \quad \text{finite} \quad (1.30)$$

where v has the dimensions of a velocity. We see that in the limit we get the equation for the propagation of waves with velocity given by v

$$\ddot{u}(x, t) = v^2 u''(x, t) \quad (1.31)$$

In the limit we have also

$$\sum_{n=1}^{N+1} \rightarrow \frac{1}{a} \int_0^L dx \quad (1.32)$$

from which

$$H = \frac{1}{2a} \int_0^L dx \left[(\dot{u}(x, t))^2 + v^2 (u'(x, t))^2 \right] \quad (1.33)$$

To get finite energy we need also a redefinition of the field variable

$$u(x, t) = \sqrt{a} \phi(x, t) \quad (1.34)$$

getting finally

$$H = \frac{1}{2} \int_0^L dx \left[(\dot{\phi}(x, t))^2 + v^2 (\phi'(x, t))^2 \right] \quad (1.35)$$

The normal modes decomposition becomes

$$\phi(x, t) = \frac{u(x, t)}{\sqrt{a}} \approx \frac{q_n(t)}{\sqrt{a}} \approx \sum_j e^{ik_j a n} \frac{Q_j}{\sqrt{a N}} \quad (1.36)$$

$$k_j = \frac{2\pi}{L} j, \quad -\infty < j < +\infty \quad (1.37)$$

giving rise to

$$\phi(x, t) = \frac{1}{\sqrt{L}} \sum_{j=-\infty}^{+\infty} e^{i \frac{2\pi}{L} j x} Q_j(t) \quad (1.38)$$

The eigenfrequencies are given by

$$\omega_j^2 = 4\omega^2 \sin^2 \left(\frac{\pi a}{L} j \right) \rightarrow 4\omega^2 \left(\frac{\pi j}{L} \right)^2 a^2 = (a\omega k_j)^2 \rightarrow v^2 k_j^2 \quad (1.39)$$

In the continuum limit the frequency is a linear function of the wave vector. The relation between the normal modes $Q_j(t)$ and the field $\phi(x, t)$ can be inverted by using the following relation

$$\int_0^L dx e^{ix(k - k')} = L \delta_{k, k'} \quad (1.40)$$

which holds for k and k' of the form (1.37). The hamiltonian is easily obtained as

$$H = \sum_{j=1}^{\infty} \left(|\dot{Q}_j|^2 + v^2 k_j^2 |Q_j|^2 \right) \quad (1.41)$$

The main result here is that in the continuum limit the hamiltonian of the system describes an infinite set of decoupled harmonic oscillators. In the following we will show that the quantization of field theories of the type described in this Section gives rise, naturally, to a description in terms of particles.

Chapter 2

Lagrangian formalism for continuum systems and quantization

2.1 String quantization

We have shown that a string of N atoms can be described in terms of a set of decoupled harmonic oscillators, and this property holds true also in the continuum limit ($N \rightarrow \infty$). In the discrete case we have shown that the hamiltonian of the system can be written as

$$H = \sum_{j=1}^{N/2} (|P_j|^2 + \omega_j^2 |Q_j|^2) \quad (2.1)$$

where

$$Q_j^\dagger = Q_{-j}, \quad P_j^\dagger = P_{-j} \quad (2.2)$$

$$\omega_j^2 = 4\omega^2 \sin^2 \frac{k_j a}{2}, \quad k_j = \frac{2\pi}{L} j, \quad |j| = 1, 2, \dots, \frac{N}{2} \quad (2.3)$$

whereas in the continuum case

$$H = \sum_{j=1}^{\infty} (|P_j|^2 + \omega_j^2 |Q_j|^2) \quad (2.4)$$

with

$$\omega_j = v|k_j| \quad (2.5)$$

and k_j given by eq. (2.3). In both cases the quantization is trivially done by introducing creation and annihilation operators

$$a_j = \sqrt{\frac{\omega_j}{2}} Q_j + i \frac{1}{\sqrt{2\omega_j}} P_j^\dagger, \quad a_j^\dagger = \sqrt{\frac{\omega_j}{2}} Q_j^\dagger - i \frac{1}{\sqrt{2\omega_j}} P_j \quad (2.6)$$

with j assuming a finite or an infinite number of values according to the system being discrete or continuum. In both cases we have

$$[a_j, a_k^\dagger] = \frac{1}{2\sqrt{\omega_j\omega_k}}[\omega_j Q_j + iP_j^\dagger, \omega_k Q_k^\dagger - iP_k] = \delta_{jk} \quad (2.7)$$

and

$$[a_j, a_k] = [a_j^\dagger, a_k^\dagger] = 0 \quad (2.8)$$

where we have made use of the canonical commutation relations

$$[Q_j, P_k] = [Q_j^\dagger, P_k^\dagger] = i\delta_{jk} \quad (2.9)$$

Notice that

$$a_{-j} = \sqrt{\frac{\omega_j}{2}}Q_{-j} + i\frac{1}{\sqrt{2\omega_j}}P_{-j}^\dagger = \sqrt{\frac{\omega_j}{2}}Q_j^\dagger + i\frac{1}{\sqrt{2\omega_j}}P_j \quad (2.10)$$

implying

$$a_{-j}^\dagger = \sqrt{\frac{\omega_j}{2}}Q_j - i\frac{1}{\sqrt{2\omega_j}}P_j^\dagger \neq a_j \quad (2.11)$$

We see that a_j e a_j^\dagger are $2N$ (in the discrete case) independent operators as Q_j and P_j . The previous relations can be inverted to give

$$Q_j = \frac{1}{\sqrt{2\omega_j}}(a_j + a_{-j}^\dagger), \quad P_j = -i\sqrt{\frac{\omega_j}{2}}(a_{-j} - a_j^\dagger) \quad (2.12)$$

In terms of a_j and a_j^\dagger the hamiltonian is

$$H = \sum_{j=1}^{N/2} \omega_j [a_j^\dagger a_j + a_{-j}^\dagger a_{-j} + 1] = \sum_{j=-N/2}^{N/2} \omega_j \left[a_j^\dagger a_j + \frac{1}{2} \right] \quad (2.13)$$

The fundamental state is characterized by the equation

$$a_j |0\rangle = 0 \quad (2.14)$$

and its energy is

$$E_0 = \sum_j \frac{\omega_j}{2} \quad (2.15)$$

In the continuum limit the energy of the fundamental state is infinite (we will come back later on this point). The generic energy eigenstate is obtained by applying to the fundamental state the creation operators (the space generated in this way is called the Fock space)

$$|n_{-N/2}, \dots, n_{N/2}\rangle = \frac{1}{(n_{-N/2}! \dots n_{N/2}!)^{1/2}} (a_{-N/2}^\dagger)^{n_{-N/2}} \dots (a_{N/2}^\dagger)^{n_{N/2}} |0\rangle \quad (2.16)$$

The state given above can be thought of being formed by $n_{-N/2}$ quanta of type $-N/2$ of energy $\omega_{-N/2}$, up to $n_{N/2}$ quanta of type $N/2$ of energy $\omega_{N/2}$. In this kind of interpretation the n_j quanta (or particles) of energy ω_j are indistinguishable one from each other. Furthermore, in a given state we can put as many particles we want. We see that we are describing a set of particles satisfying the Bose-Einstein statistics. Formally this follows from the commutation relation

$$[a_i^\dagger, a_j^\dagger] = 0 \quad (2.17)$$

from which the symmetry of the wave-function follows. For instance a two-particle state is given by

$$|i, j\rangle = a_i^\dagger a_j^\dagger |0\rangle = |j, i\rangle \quad (2.18)$$

As we have already noticed the energy of the fundamental state becomes infinite in the continuum limit. This is perhaps the most simple of the infinities that we will encounter in our study of field quantization. We will learn much later in this course how it is possible to keep them under control. For the moment being let us notice that in the usual cases only relative energies are important, and then the value of E_0 (see eq. (2.15)) is not physically relevant. However there are situations, as in the Casimir effect (see later) where it is indeed relevant. Forgetting momentarily these special situations we can define a new hamiltonian by subtracting E_0 . This can be done in a rather formal way by defining the concept of **normal ordering**. Given an operator which is a monomial in the creation and annihilation operators, we define its normal ordered form by taking all the annihilation operators to the right of the creation operators. We then extend the definition to polynomials by linearity. For instance, in the case of the hamiltonian (2.4) we have

$$: H : \equiv N(H) = \sum_j \frac{\omega_j}{2} N(a_j^\dagger a_j + a_j a_j^\dagger) = \sum_j \omega_j a_j^\dagger a_j \quad (2.19)$$

Coming back to the discrete case, recalling eqs. (1.13) and (1.14)

$$q_n = \sum_j e^{i\frac{2\pi}{N}jn} \frac{Q_j}{\sqrt{N}}, \quad p_n = \sum_j e^{-i\frac{2\pi}{N}jn} \frac{P_j}{\sqrt{N}} \quad (2.20)$$

and using the canonical commutators (2.9), we get

$$[q_n, p_m] = \sum_{jk} e^{i\frac{2\pi}{N}(jn - km)} \frac{1}{N} [Q_j, P_k] = \frac{i}{N} \sum_j e^{i\frac{2\pi}{N}j(n-m)} = i\delta_{nm} \quad (2.21)$$

In the continuum case we use the analogue expansion

$$\phi(x, t) = \frac{1}{\sqrt{L}} \sum_{j=-\infty}^{+\infty} e^{i\frac{2\pi}{L}jx} Q_j, \quad \dot{\phi}(x, t) = \frac{1}{\sqrt{L}} \sum_{j=-\infty}^{+\infty} e^{-i\frac{2\pi}{L}jx} P_j \quad (2.22)$$

from which

$$\begin{aligned}
[\phi(x, t), \dot{\phi}(y, t)] &= \frac{1}{L} \sum_{jk} e^{i\frac{2\pi}{L}(jx - ky)} i\delta_{jk} \\
&= \frac{i}{L} \sum_{j=-\infty}^{+\infty} e^{i\frac{2\pi}{L}j(x-y)} = i\delta(x-y)
\end{aligned} \tag{2.23}$$

This relation could have been obtained from the continuum limit by recalling that

$$\phi(x, t) \approx \frac{u(x, t)}{\sqrt{a}} \approx \frac{q_n}{\sqrt{a}} \tag{2.24}$$

implying

$$[\phi(x_n, y), \dot{\phi}(x_m, t)] = i\frac{\delta_{nm}}{a} \tag{2.25}$$

In the limit

$$\lim_{a \rightarrow 0} \frac{\delta_{nm}}{a} = \delta(x-y) \tag{2.26}$$

if for $a \rightarrow 0$, $x_n \rightarrow x$, and $x_m \rightarrow y$. In fact

$$1 = \sum_n a \left(\frac{\delta_{nm}}{a} \right) \rightarrow \int dx \left(\lim_{a \rightarrow 0} \frac{\delta_{nm}}{a} \right) \tag{2.27}$$

showing that the properties of a delta-approximation are indeed satisfied. It follows that we have the following correspondence between the discrete and the continuum case

$$q_n \rightarrow \phi(x, t), \quad p_n \rightarrow \dot{\phi}(x, t) \tag{2.28}$$

Said in different words, $\phi(x, t)$ e $\dot{\phi}(x, t)$ appear to be the canonical variables in the limit. This remark suggests a way to approach the quantization of a field theory different from the one followed so far. The way we have used is based upon the construction of the normal modes of oscillation, but in the discrete case this is not necessary at all. In fact, in such a case, the quantization is made starting from the commutation relations among the canonical variables, $[q, p] = i$, without having an *a priori* knowledge of the dynamics of the system. This suggests that one should start directly by the field operators $\phi(x, t)$ e $\dot{\phi}(x, t)$, and quantize the theory by requiring $[\phi(x, t), \dot{\phi}(y, t)] = i\delta(x-y)$. To make this approach a consistent one, we need to extend the hamiltonian and lagrangian description to a continuum system. Let us recall how we proceed in the discrete case. We start by giving a lagrangian function $L(q_n, \dot{q}_n, t)$. Then we define the conjugated momenta by the equation

$$p_n = \frac{\partial L}{\partial \dot{q}_n} \tag{2.29}$$

We then go the hamiltonian formalism by taking the conjugated momenta, p_n , as independent variables. The previous equation is used in order to solve the velocities in terms of q_n and p_n . Next we define the hamiltonian as

$$H(q_n, p_n) = \sum_n p_n \dot{q}_n - L \quad (2.30)$$

At the classical level the time evolution of the observables is obtained through the equation

$$\dot{A} = \{A, H\} \quad (2.31)$$

where the Poisson brackets can be defined starting from the brackets between the canonical variables $\{q_n, p_m\} = \delta_{nm}$. The theory is then quantized through the rule

$$[.,.] \rightarrow i\{.,.\} \quad (2.32)$$

In the next Section we will learn how to extend the lagrangian and hamiltonian formalism to the continuum case.

2.2 The lagrangian formalism for continuum systems

We will now show how to construct the lagrangian starting from the equations of motion. For the string this can be simply done by starting from the kinetic energy and the potential energy. Let us start recalling the procedure in the discrete case. In this case the kinetic energy is given by

$$\begin{aligned} T &= \frac{1}{2} \sum_{n=1}^N p_n^2 = \frac{1}{2} \sum_{n=1}^N \dot{u}^2(x_n, t) \\ &= \frac{1}{2} \sum_{n=1}^N a \dot{\phi}^2(x_n, t) \rightarrow \frac{1}{2} \int_0^L \dot{\phi}^2(x, t) dx \end{aligned} \quad (2.33)$$

whereas the potential energy is

$$\begin{aligned} U &= \frac{1}{2} \sum_{n=1}^N \omega^2 (q_n - q_{n+1})^2 \\ &= \frac{1}{2} \sum_{n=1}^N \omega^2 (u(x_n, t) - u(x_{n+1}, t))^2 \\ &= \frac{1}{2} \sum_{n=1}^N \omega^2 a (\phi(x_n, t) - \phi(x_{n+1}, t))^2 \end{aligned} \quad (2.34)$$

and recalling that for $a \rightarrow 0$, $v = a\omega$, is finite, it follows

$$U = \frac{1}{2} \sum_{n=1}^N av^2 \left(\frac{\phi(x_n, t) - \phi(x_{n+1}, t)}{a} \right)^2 \rightarrow \frac{v^2}{2} \int_0^L \phi'^2(x, t) dx \quad (2.35)$$

Therefore the total energy and the lagrangian are respectively

$$E = T + U = \frac{1}{2} \int_0^L dx \left[\dot{\phi}^2(x, t) + v^2 \phi'^2(x, t) \right] \quad (2.36)$$

and

$$L = T - U = \frac{1}{2} \int_0^L dx \left[\dot{\phi}^2(x, t) - v^2 \phi'^2(x, t) \right] \quad (2.37)$$

The important result is that in the continuum limit, the lagrangian can be written as a spatial integral of a function of the field ϕ and its first derivatives, which will be called lagrangian density, and having the expression

$$\mathcal{L} = \frac{1}{2} (\dot{\phi}^2 - v^2 \phi'^2) \quad (2.38)$$

The total lagrangian is obtained by integrating spatially the lagrangian density

$$L = \int_0^L \mathcal{L} dx \quad (2.39)$$

Of course, this is not the most general situation one can envisage, but we will consider only the case in which the lagrangian density is a local function of the field and its derivatives

$$L = \int \mathcal{L}(\phi, \dot{\phi}, \phi', x, t) dx \quad (2.40)$$

Furthermore, we will consider only theories in which the lagrangian contains at most the first derivatives of the fields. The reason is that otherwise one can run into problems with the conservation of probability.

Given the lagrangian, the next step is to build up the action functional. The extrema of the action give rise to the equations of motion. The action is given by

$$S = \int_{t_1}^{t_2} L dt = \int_{t_1}^{t_2} dt \int dx \mathcal{L}(\phi, \dot{\phi}, \phi', x, t) \quad (2.41)$$

We require that S is stationary with respect to those variations that are consistent with the boundary conditions satisfied by the fields. If Σ is the spatial surface delimiting the region of spatial integration (for the string Σ reduces to the end points), we will ask that

$$\delta\phi(x, t) = 0 \quad \text{on } \Sigma \quad (2.42)$$

Furthermore we will require that the variations at the times t_1 and t_2 are zero at any space point x

$$\delta\phi(x, t_1) = \delta\phi(x, t_2) = 0, \quad \text{at any } x \quad (2.43)$$

In the discrete case we have only boundary conditions of the second type, but here the first ones are necessary in order to be consistent with the boundary conditions

for the field. Let us now require the stationarity of S with respect to variations satisfying the previous boundary conditions (2.42) and (2.43)

$$0 = \delta S = \int_{t_1}^{t_2} dt \int dx \delta \mathcal{L} = \int_{t_1}^{t_2} dt \int dx \left(\frac{\partial \mathcal{L}}{\partial \phi} \delta \phi + \frac{\partial \mathcal{L}}{\partial \dot{\phi}} \delta \dot{\phi} + \frac{\partial \mathcal{L}}{\partial \phi'} \delta \phi' \right) \quad (2.44)$$

Integrating by parts

$$\begin{aligned} 0 &= \int_{t_1}^{t_2} dt \int dx \left[\frac{\partial \mathcal{L}}{\partial \phi} \delta \phi + \frac{\partial}{\partial t} \left(\frac{\partial \mathcal{L}}{\partial \dot{\phi}} \delta \phi \right) - \left(\frac{\partial}{\partial t} \frac{\partial \mathcal{L}}{\partial \dot{\phi}} \right) \delta \phi \right. \\ &\quad \left. + \frac{\partial}{\partial x} \left(\frac{\partial \mathcal{L}}{\partial \phi'} \delta \phi \right) - \left(\frac{\partial}{\partial x} \frac{\partial \mathcal{L}}{\partial \phi'} \right) \delta \phi \right] \\ &= \int dx \left[\frac{\partial \mathcal{L}}{\partial \dot{\phi}} \delta \phi \right]_{t_1}^{t_2} + \int_{t_1}^{t_2} dt \left[\frac{\partial \mathcal{L}}{\partial \phi'} \delta \phi \right]_0^L \\ &\quad + \int_{t_1}^{t_2} dt \int dx \left[\frac{\partial \mathcal{L}}{\partial \phi} - \frac{\partial}{\partial t} \frac{\partial \mathcal{L}}{\partial \dot{\phi}} - \frac{\partial}{\partial x} \frac{\partial \mathcal{L}}{\partial \phi'} \right] \delta \phi \end{aligned} \quad (2.45)$$

The boundary terms are zero due to eqs. (2.42) and (2.43). Then from the arbitrariness of $\delta \phi$ within the region of integration, we get the Euler-Lagrange equations

$$\frac{\partial \mathcal{L}}{\partial \phi} - \frac{\partial}{\partial t} \frac{\partial \mathcal{L}}{\partial \dot{\phi}} - \frac{\partial}{\partial x} \frac{\partial \mathcal{L}}{\partial \phi'} = 0 \quad (2.46)$$

In fact $\delta \phi$ can be chosen to be zero everywhere except for a small region around any given point x (see Fig. (2.1)).



Fig. 2.1 - Here the arbitrary variation $\delta \phi(x)$ is chosen to be zero all along the string, except for a small region around the point x .

This discussion can be easily extended to the case of N fields ϕ_i , $i = 1, \dots, N$ (think, as an example, to the electromagnetic field), and to the case of n spatial dimensions with points labelled by x_α , $\alpha = 1, \dots, n$. In this case the structure of the action will be

$$S = \int_{t_1}^{t_2} dt \int_V d^n x \mathcal{L} \left(\phi_i, \dot{\phi}_i, \frac{\partial \phi_i}{\partial x_\alpha} \right) \quad (2.47)$$

Here V is the spatial volume of integration. We will require again the stationarity of the action with respect to variations of the fields satisfying the boundary conditions

$$\delta\phi_i(x_\alpha, t) = 0, \quad \text{on } \Sigma, \text{ for any } t, \quad t_1 \leq t \leq t_2 \quad (2.48)$$

where Σ is the boundary of V , and

$$\delta\phi_i(x_\alpha, t_1) = \delta\phi_i(x_\alpha, t_2) = 0, \quad \text{for any } x_\alpha \in V \quad (2.49)$$

The first boundary conditions are required because, in the general case, one requires the fields to go to zero at the boundary of the spatial region (usually the infinite). The Euler-Lagrange equations one gets in this case are

$$\frac{\partial \mathcal{L}}{\partial \phi_i} - \frac{\partial}{\partial t} \frac{\partial \mathcal{L}}{\partial \dot{\phi}_i} - \frac{\partial}{\partial x_\alpha} \frac{\partial \mathcal{L}}{\partial \frac{\partial \phi_i}{\partial x_\alpha}} = 0, \quad i = 1, \dots, N, \quad \alpha = 1, \dots, n \quad (2.50)$$

To go to the hamiltonian description one introduces the momentum densities conjugated to the fields ϕ_i :

$$\Pi_i = \frac{\partial \mathcal{L}}{\partial \dot{\phi}_i} \quad (2.51)$$

and the hamiltonian density

$$\mathcal{H} = \sum_i \Pi_i \dot{\phi}_i - \mathcal{L} \quad (2.52)$$

In the case of the string one gets from eq. (2.37)

$$\frac{\partial \mathcal{L}}{\partial \dot{\phi}} = \dot{\phi}, \quad \frac{\partial \mathcal{L}}{\partial \phi'} = -v^2 \phi', \quad \frac{\partial \mathcal{L}}{\partial \phi} = 0 \quad (2.53)$$

From which one recovers the equations of motion for the field ϕ . Furthermore

$$\Pi = \dot{\phi} \quad (2.54)$$

implying

$$\mathcal{H} = \Pi \dot{\phi} - \mathcal{L} = \Pi^2 - \left(\frac{1}{2} \Pi^2 - \frac{1}{2} v^2 \phi'^2 \right) = \frac{1}{2} \left(\Pi^2 + v^2 \phi'^2 \right) \quad (2.55)$$

which coincides with the energy density given in eq. (2.36).

A big merit of the lagrangian formalism is the possibility to formulate in a simple way the symmetry properties of the theory. We shall see later on that this is due to the first theorem of Emmy Noether which allows to put in a direct relation the symmetry properties of the lagrangian and the conservation laws. Due to this correspondence it is also possible to make use of the theorem in a constructive way, that is to restrict the possible forms of the lagrangian from the requirement of a given set of symmetries. We will discuss later on the theorem. For the moment being we will show how the equations of the vibrating string give rise to conservation laws.

The energy contained in the segment $[a, b]$ of the string, with $0 \leq a \leq b \leq L$ is given by

$$E(a, b) = \frac{1}{2} \int_a^b dx [\dot{\phi}^2 + v^2 \phi'^2] \quad (2.56)$$

We can evaluate its time variation

$$\begin{aligned} \frac{dE(a, b)}{dt} &= \int_a^b dx [\dot{\phi}\ddot{\phi} + v^2 \phi' \dot{\phi}'] = v^2 \int_a^b dx [\dot{\phi}\phi'' + \phi' \dot{\phi}'] \\ &= v^2 \int_a^b dx \frac{\partial}{\partial x} [\dot{\phi}\phi'] = v^2 [\dot{\phi}\phi']_a^b \end{aligned} \quad (2.57)$$

where we have made use of the equations of motion in the second step. Defining the local quantity

$$P(x, t) = -v^2 \dot{\phi}\phi' \quad (2.58)$$

which is the analogous of the Poynting's vector in electrodynamics, we get

$$-\frac{dE(a, b)}{dt} = [P(b, t) - P(a, t)] \quad (2.59)$$

This is the classical energy conservation law, expressing the fact that if the energy decreases in the segment $[a, b]$, then there must be a flux of energy at the end points a and b . The total energy is conserved due to the boundary conditions, $P(0, t) = P(L, t)$. But the previous law says something more, because it gives us a local conservation law, as it follows by taking the limit $b \rightarrow a$. In fact, in this limit

$$E(a, b) \rightarrow (b - a)\mathcal{H} \quad (2.60)$$

with \mathcal{H} given by (2.55), and

$$\frac{\partial \mathcal{H}}{\partial t} + \frac{\partial P}{\partial x} = 0 \quad (2.61)$$

This conservation law can be checked by using the explicit expressions of \mathcal{H} and P , and the equations of motion.

2.3 The canonical quantization of a continuum system

As we have seen in Section 2.2, in a field theory one defines the density of conjugated momenta as

$$\Pi_i = \frac{\partial \mathcal{L}}{\partial \dot{\phi}_i} \quad (2.62)$$

it is then natural to assume the following commutation relations

$$[\phi_i(x_\alpha, t), \Pi_j(y_\alpha, t)] = i\delta_{ij}\delta^n(x_\alpha - y_\alpha) \quad \alpha = 1, \dots, n, \quad i, j = 1, \dots, N \quad (2.63)$$

and

$$[\phi_i(x_\alpha, t), \phi_j(y_\alpha, t)] = 0, \quad [\Pi_i(x_\alpha, t), \Pi_j(y_\alpha, t)] = 0 \quad (2.64)$$

In the string case we have $\Pi = \dot{\phi}$ and we reproduce eq. (2.23). Starting from the previous commutation relations and expanding the field in terms of normal modes one gets back the commutation relations for the creation and annihilation operators. Therefore we reconstruct the particle interpretation. Using the Heisenberg representation (but omitting from now on the corresponding index for the operators), the expansion of the string field in terms of creation and annihilation operators is obtained through the eqs. (2.22) and (2.12).

$$\begin{aligned} \phi(x, t) &= \frac{1}{\sqrt{L}} \sum_j e^{i\frac{2\pi}{L}jx} Q_j \\ &= \frac{1}{\sqrt{L}} \sum_j \frac{1}{\sqrt{2\omega_j}} e^{i\frac{2\pi}{L}jx} (a_j(t) + a_{-j}^\dagger(t)) \\ &= \frac{1}{\sqrt{L}} \sum_j \frac{1}{\sqrt{2\omega_j}} \left[e^{i\frac{2\pi}{L}jx} a_j(t) + e^{-i\frac{2\pi}{L}jx} a_j^\dagger(t) \right] \end{aligned} \quad (2.65)$$

Using the equations of motion of the string

$$\ddot{\phi} - v^2 \phi'' = 0 \quad (2.66)$$

we find from the above expansion of ϕ in terms of Q_j

$$\ddot{Q}_j + \omega_j^2 Q_j = 0 \quad (2.67)$$

Using the decomposition (2.6) of a_j in terms of Q_j and $P_j = \dot{Q}_j^\dagger$, we get

$$\dot{a}_j + i\omega_j a_j = 0 \quad (2.68)$$

from which

$$a_j(t) = a_j(0)e^{-i\omega_j t} \equiv a_j e^{-i\omega_j t}, \quad a_j^\dagger(t) = a_j^\dagger(0)e^{i\omega_j t} \equiv a_j^\dagger e^{i\omega_j t} \quad (2.69)$$

and

$$\phi(x, t) = \frac{1}{\sqrt{L}} \sum_j \frac{1}{\sqrt{2\omega_j}} \left[e^{i\left(\frac{2\pi}{L}jx - \omega_j t\right)} a_j + e^{-i\left(\frac{2\pi}{L}jx - \omega_j t\right)} a_j^\dagger \right] \quad (2.70)$$

From this equation one gets immediately the commutation rules for the creation and annihilation operators, but before doing that let us notice the structure of the previous expansion. This can be written in the following way

$$\phi(x, t) = \sum_j \left[f_j(x, t) a_j + f_j^*(x, t) a_j^\dagger \right] \quad (2.71)$$

with

$$f_j(x, t) = \frac{1}{\sqrt{2\omega_j L}} e^{i\left(\frac{2\pi}{L} j x - i\omega_j t\right)} \quad (2.72)$$

or

$$f_j(x, t) = \frac{1}{\sqrt{2\omega_j L}} e^{i(k_j x - i\omega_j t)} \quad (2.73)$$

where we have made use of the definition of k_j (see eq.(1.37))

$$k_j = \frac{2\pi}{L} j \quad (2.74)$$

The functions $f_j(x, t)$ and their complex conjugated satisfy the wave equation

$$\frac{\partial^2 f_j(x, t)}{\partial t^2} - v^2 \frac{\partial^2 f_j(x, t)}{\partial x^2} = 0 \quad (2.75)$$

and the boundary conditions

$$f_j(0, t) = f_j(L, t) \quad (2.76)$$

It is immediate to verify that they are a complete set of orthonormal functions

$$\sum_j f_j^*(x, t) i \partial_t^{(-)} f_j(y, t) = \delta(x - y) \quad (2.77)$$

$$\int_0^L dx f_j^*(x, t) i \partial_t^{(-)} f_l(x, t) = \delta_{jl} \quad (2.78)$$

where

$$A \partial_t^{(-)} B = A(\partial_t B) - (\partial_t A) B \quad (2.79)$$

Let us consider the first relation. We have

$$\sum_j f_j^*(x, t) i \partial_t^{(-)} f_j(y, t) = \sum_j 2\omega_j f_j^*(x, t) f_j(y, t) = \sum_j \frac{1}{L} e^{-ik_j(x-y)} = \delta(x-y) \quad (2.80)$$

Evaluating this expression with two $f_j(x, t)$'s or two $f_j^*(x, t)$'s one gets zero. As far as the second relation is concerned we get

$$\begin{aligned} \int_0^L dx f_j^*(x, t) i \partial_t^{(-)} f_l(x, t) &= \int_0^L dx [\omega_l + \omega_j] f_j^*(x, t) f_l(x, t) \\ &= \frac{1}{L} \frac{\omega_l + \omega_j}{2\sqrt{\omega_j \omega_l}} \int_0^L dx e^{ix(k_l - k_j)} e^{i(\omega_j - \omega_l)t} \\ &= \frac{1}{L} \frac{\omega_l + \omega_j}{2\sqrt{\omega_j \omega_l}} e^{i(\omega_j - \omega_l)t} L \delta_{jl} = \delta_{jl} \end{aligned} \quad (2.81)$$

Also in this case, by taking two $f_j(x, t)$'s or two $f_j^*(x, t)$'s, the result is zero due to the factor $\omega_l - \omega_j$.

We repeat that the set $f_j(x, t)$ is a complete set of orthonormal solutions of the wave equation with periodic boundary conditions. A legitimate question is why the operator $\partial_t^{(-)}$ appears in these relations. The reason is that the scalar product should be time independent (otherwise two orthonormal solutions at a given time could lose these features at a later time). For instance, in the case of the Schrödinger equation, we define the scalar product as

$$\int d^3x \psi^*(\vec{x}, t) \psi(\vec{x}, t) \quad (2.82)$$

because for hermitian hamiltonians this is indeed time independent, as it can be checked by differentiating the scalar product with respect to time and using the Schrödinger equation:

$$\frac{d}{dt} \int d^3x \psi^*(\vec{x}, t) \psi(\vec{x}, t) = \int d^3x [\dot{\psi}^* \psi + \psi^* \dot{\psi}] = \int d^3x [i(H\psi)^* \psi - i\psi^*(H\psi)] = 0 \quad (2.83)$$

In the present case we can define a time independent scalar product, by considering two solutions f and \tilde{f} of the wave equation, and evaluating the following two expressions

$$\int_0^L dx \tilde{f} \left[\frac{\partial^2 f}{\partial t^2} - v^2 \frac{\partial^2 f}{\partial x^2} \right] = 0 \quad (2.84)$$

$$\int_0^L dx \left[\frac{\partial^2 \tilde{f}}{\partial t^2} - v^2 \frac{\partial^2 \tilde{f}}{\partial x^2} \right] f = 0 \quad (2.85)$$

Subtracting these two expressions one from the other we get

$$\int_0^L dx \left[\frac{\partial}{\partial t} \left(\tilde{f} \frac{\partial f}{\partial t} - \frac{\partial \tilde{f}}{\partial t} f \right) - v^2 \frac{\partial}{\partial x} \left(\tilde{f} \frac{\partial f}{\partial x} - \frac{\partial \tilde{f}}{\partial x} f \right) \right] \quad (2.86)$$

If both f and \tilde{f} satisfy periodic boundary conditions, the second term is zero, and it follows that the quantity

$$\int_0^L dx \tilde{f} \partial_t^{(-)} f \quad (2.87)$$

is a constant of motion. Using eq. (2.78), we can invert the relation between field and creation and annihilation operators. We get

$$\int_0^L dx f_j^*(x, t) i \partial_t^{(-)} \phi(x, t) = \sum_k \int_0^L dx f_j^*(x, t) i \partial_t^{(-)} [f_k(x, t) a_k + f_k^*(x, t) a_k^\dagger] = a_j \quad (2.88)$$

and therefore

$$a_j = \int_0^L dx f_j^*(x, t) i \partial_t^{(-)} \phi(x, t) \quad (2.89)$$

and

$$a_j^\dagger = \int_0^L dx \phi(x, t) i \partial_t^{(-)} f_j(x, t) \quad (2.90)$$

From the field commutation relations we find

$$\begin{aligned} [a_j, a_k^\dagger] &= \int_0^L dx dy [(i f_j^* \dot{\phi} - i \dot{f}_j^* \phi)_{(x,t)}, i \phi \dot{f}_k - i \dot{\phi} f_k]_{(y,t)} \\ &= \int_0^L dx dy (-f_j^* \dot{f}_k (-i \delta(x-y)) - \dot{f}_k^* f_j (i \delta(x-y))) \\ &= \int_0^L dx f_j^* i \partial_t^{(-)} f_k = \delta_{jk} \end{aligned} \quad (2.91)$$

In analogous way we get

$$[a_j, a_k] = [a_j^\dagger, a_k^\dagger] = 0 \quad (2.92)$$

We have seen that the total energy of the string is a constant of motion. There is another constant which corresponds to the total momentum of the string, defined by

$$P = \int_0^L dx \mathcal{P} = - \int_0^L dx \dot{\phi} \phi' \quad (2.93)$$

We will show in the following that this expression is just the total momentum of the string, by showing that its conservation derives from the invariance of the theory under spatial translations. For the moment being let us check that this is in fact a conserved quantity:

$$\frac{dP}{dt} = - \int_0^L dx (\ddot{\phi} \phi' + \dot{\phi} \phi'') = - \int_0^L dx \frac{\partial}{\partial x} \frac{1}{2} (\dot{\phi}^2 + v^2 \phi'^2) = 0 \quad (2.94)$$

where we have used the equations of motion of the string and the boundary conditions. By using the field expansion

$$\begin{aligned} P &= - \sum_{j,l} \int_0^L dx \omega_j k_l [f_j a_j - f_j^* a_j^\dagger] [f_l a_l - f_l^* a_l^\dagger] \\ &= - \sum_{j,l} \int_0^L dx \frac{\omega_j k_l}{2L \sqrt{\omega_j \omega_l}} \left[e^{i(k_j x - \omega_j t)} a_j - e^{-i(k_j x - \omega_j t)} a_j^\dagger \right] \\ &\quad \times \left[e^{i(k_l x - \omega_l t)} a_l - e^{-i(k_l x - \omega_l t)} a_l^\dagger \right] \\ &= - \sum_l \frac{1}{2} k_l [a_{-l} a_l e^{-2i\omega_l t} + a_{-l}^\dagger a_l^\dagger e^{2i\omega_l t} - a_l a_l^\dagger - a_l^\dagger a_l] \end{aligned} \quad (2.95)$$

The first two terms in the last step give zero contribution because they are antisymmetric in the index of summation ($k_l \approx l$). Therefore

$$P = \frac{1}{2} \sum_j k_j [a_j a_j^\dagger + a_j^\dagger a_j] = \sum_j k_j a_j^\dagger a_j \quad (2.96)$$

where we have used

$$\sum_j k_j = 0 \quad (2.97)$$

for the antisymmetry j . We see that P has an expression similar to that of H (see eq. (2.19)). We deduce that the states

$$(a_{-N/2}^\dagger)^{n_{-N/2}} \dots (a_j^\dagger)^{n_j} \dots |0\rangle = |\psi\rangle \quad (2.98)$$

have energy

$$H|\psi\rangle = (n_{-N/2}\omega_{-N/2} + \dots + n_j\omega_j + \dots)|\psi\rangle \quad (2.99)$$

and a momentum

$$P|\psi\rangle = (n_{-N/2}k_{-N/2} + \dots + n_jk_j + \dots)|\psi\rangle \quad (2.100)$$

as it follows from

$$[H, a_j^\dagger] = \omega_j a_j^\dagger, \quad [P, a_j^\dagger] = k_j a_j^\dagger \quad (2.101)$$

In a complete general way, if an operator A can be written as

$$A = \sum_j \alpha_j a_j^\dagger a_j \quad (2.102)$$

we have

$$[A, a_j^\dagger] = \alpha_j a_j^\dagger \quad (2.103)$$

Then, if $|\rho\rangle$ is an eigenket of A with eigenvalue ρ , $a_j^\dagger|\rho\rangle$ is an eigenket of A with eigenvalue $\rho + \alpha_j$. Therefore a_j^\dagger and a_j increase and lower the eigenvalues of A . This is a trivial consequence of the commutation relations

$$A(a_j^\dagger|\rho\rangle) = (a_j^\dagger A + \alpha_j a_j^\dagger)|\rho\rangle = (\rho + \alpha_j)a_j^\dagger|\rho\rangle \quad (2.104)$$

Chapter 3

The Klein-Gordon field

3.1 Relativistic quantum mechanics and its problems

The extension of quantum mechanics to the relativistic case gives rise to numerous problems. The difficulties originate from the relativistic dispersion relation

$$E^2 = |\vec{p}|^2 + m^2 \quad (3.1)$$

This relation gives rise to two solutions

$$E = \pm \sqrt{|\vec{p}|^2 + m^2} \quad (3.2)$$

It is not difficult to convince himself that the solutions with negative energy have unphysical behaviour. For instance, increasing the momentum, the energy decreases! But their presence is not a real problem at a classical level. In fact, we see from eq. (3.2) that there is a gap of at least $2m$ between the energies of the two types of solutions. At the classical level, the way in which the energy is transferred is always a continuous one. So there is no way to start with an energy positive particle and finish with a negative energy one. On the contrary, in quantum mechanics one can, through the emission of a quantum of energy $E > 2m$, go from positive energy to negative energy states. Since a system behaves in such a way to lower its energy, all the positive energy states would migrate to negative energy ones, causing a collapse of the usual matter. In fact we shall see that it is not possible to ignore this kind of solutions, but they will be reinterpreted in terms of antiparticles. This will allow us to get rid of the problems connected with the negative energy solutions, but it will cause another problem. In fact, one of the properties of antiparticles is that they may be annihilated or pair created. Let us suppose now to try to localize a particle on a distance of the order of its Compton wave-length, that is of order $1/m$. By doing that we will allow an uncertainty on the momentum of about m , due to the uncertainty principle. This means that the momentum (and the energy)

of the particle could reach values of order $2m$, enough to create a pair particle-antiparticle. This will be possible only violating the conservation of energy and momentum. Again, this is the case if the violation of energy conservation is on a time-scale of order $\Delta t \approx \Delta x \approx 1/m$. But this is the scale of the Compton wavelength, therefore the attempt of localization will be nullified by the fact that at the same scale we start pair creating particles and antiparticles, meaning that we will be unable to define the concept of a localized single particle. At the Compton scale there is no such a thing as a particle, but the picture we get from the previous considerations is the one of a cloud of particles and antiparticles surrounding our initial particle, and there is no way to distinguish our particle from the many around it.

These considerations imply that the relativistic theories cannot be seen as theories at a fixed number of particles, which is the usual way of describing things in ordinary quantum mechanics. In this sense a field theory, as far as we have seen till now, looks as the most natural way to describe such systems. In fact, it embeds, in a natural way, the possibility of describing situations with variable number of particles.

One can look also at different ways leading to the necessity of using field theories. For instance, by looking at the quantization of the electromagnetic field, physicists realized that this gives a natural explanation of the particle-wave duality, and that in the particle description one has to do with a variable number of photons. On the contrary, physical entities as the electrons, were always described in particle terms till 1927, when Davisson and Germer showed experimentally their wave-like behavior. This suggested that the particle-wave duality would be a feature valid for any type of waves or particles. Therefore, based on the analogy with the electromagnetic field, it is natural to introduce a field for any kind of particle.

Historically, the attempt of making quantum mechanics a relativistic theory was pursued by looking for relativistic generalizations of the Schrödinger equation. Later it was realized that these equations should be rather used as equations for the fields describing the corresponding particles. As we shall see, these equations describe correctly the energy dispersion relation and the spin of the various particles. Therefore they can be used as a basis for the expansion of the field in terms of creation and annihilation operators. In order to illustrate this procedure, let us start considering the Schrödinger equation for a free particle

$$i \frac{\partial \psi}{\partial t} = H \psi \quad (3.3)$$

where H is the hamiltonian

$$H = \frac{|\vec{p}|^2}{2m} = -\frac{1}{2m} |\vec{\nabla}|^2 \quad (3.4)$$

If ψ describes an eigenstate of the energy and of the momentum

$$\psi \approx e^{-iEt + i\vec{p} \cdot \vec{x}} \quad (3.5)$$

all the information in the equation is to describe correctly the energy-momentum relation

$$E = \frac{|\vec{p}|^2}{2m} \quad (3.6)$$

In the relativistic case one could try to reproduce the positive energy branch of the dispersion relation (3.1). In that case one could start from the hamiltonian

$$H = \sqrt{|\vec{p}|^2 + m^2} \quad (3.7)$$

which gives rise to the following wave equation

$$i \frac{\partial \psi}{\partial t} = \left(\sqrt{-|\vec{\nabla}|^2 + m^2} \right) \psi \quad (3.8)$$

The two obvious problems of this equation are

- spatial and time derivatives appear in a non symmetric way;
- the equation is non-local, that is it depends on an infinite number of spatial derivatives

$$\left(\sqrt{-|\vec{\nabla}|^2 + m^2} \right) \psi = m \left(\sqrt{1 - \frac{|\vec{\nabla}|^2}{m^2}} \right) \psi = m \sum_k c_k \left(|\vec{\nabla}|^2 \right)^k \psi \quad (3.9)$$

Both these difficulties are eliminated by iteration

$$-\frac{\partial^2 \psi}{\partial t^2} = \left(-|\vec{\nabla}|^2 + m^2 \right) \psi \quad (3.10)$$

This equation is both local and invariant under Lorentz transformations, in fact we can write it in the following form

$$\left(\partial^2 + m^2 \right) \psi = 0 \quad (3.11)$$

where

$$\partial^2 = \frac{\partial^2}{\partial t^2} - |\vec{\nabla}|^2 \quad (3.12)$$

is the D'Alembert operator in $(3 + 1)$ dimensions. Notice that in order to solve the difficulties we have listed above we have been obliged to consider both types of solutions: positive energy, $E = \sqrt{|\vec{p}|^2 + m^2}$, and negative energy $E = -\sqrt{|\vec{p}|^2 + m^2}$. The equation we have obtained in this way is known as the Klein-Gordon equation. As relativistic extension of the Schrödinger theory it was initially discarded because it gives rise to a non definite positive probability. In fact, if ψ and ψ^* are two solutions of such an equation, we can write the following identity

$$0 = \psi^* \left(\partial^2 + m^2 \right) \psi - \psi \left(\partial^2 + m^2 \right) \psi^* = \partial_\mu [\psi^* \partial^\mu \psi - (\partial^\mu \psi^*) \psi] \quad (3.13)$$

Therefore the current

$$J_\mu = \psi^* \partial_\mu \psi - (\partial_\mu \psi^*) \psi \quad (3.14)$$

has zero four-divergence and the quantity

$$\int d^3x J_0 = \int d^3x (\psi^* \dot{\psi} - \dot{\psi}^* \psi) \quad (3.15)$$

is a constant of motion. But we cannot interpret the time-component of the current as a probability density, as we do in the Schrödinger case, because it is not positive definite.

Let us end this Section by stating our conventions for the relativistic notations. The position and momentum four-vectors are given by

$$x^\mu = (t, \vec{x}), \quad p^\mu = (E, \vec{p}), \quad \mu = 0, 1, 2, 3 \quad (3.16)$$

The metric tensor $g_{\mu\nu}$ is diagonal with components $(+1, -1, -1, -1)$. The four-momentum operator in coordinate space is given by

$$p^\mu \rightarrow i \frac{\partial}{\partial x_\mu} = \left(i \frac{\partial}{\partial t}, -i \vec{\nabla} \right) \quad (3.17)$$

We have also the following relations

$$p^2 = p^\mu p_\mu \rightarrow -\frac{\partial}{\partial x_\mu} \frac{\partial}{\partial x^\mu} = -\partial^2 \quad (3.18)$$

$$x \cdot p = Et - \vec{p} \cdot \vec{x} \quad (3.19)$$

3.2 Quantization of the Klein-Gordon field

In this Section we will discuss the quantization of the Klein-Gordon field, that is a field satisfying the equation (3.11). The quantization will be performed by following the steps we have previously outlined, that is

- construction of the lagrangian density and determination of the canonical momentum density $\Pi(x)$;
- quantization through the requirement of canonical commutation relations

$$[\phi(x, t), \Pi(y, t)] = i\delta^3(x - y), \quad [\phi(x, t), \phi(y, t)] = 0, \quad [\Pi(x, t), \Pi(y, t)] = 0 \quad (3.20)$$

- expansion of $\phi(x, t)$ in terms of a complete set of solutions of the Klein-Gordon equation, allowing the definition of creation and annihilation operators;
- construction of the Fock space through the creation and annihilation operators.

We start by the construction of the lagrangian, requiring that the related Euler-Lagrangian equation gives rise to the Klein-Gordon equation. To this end let us recall how one proceeds in the discrete case. Suppose to have a system of N degrees of freedom satisfying the following equations of motion

$$m_i \ddot{q}_i = -\frac{\partial V}{\partial q_i} \quad (3.21)$$

Multiplying these equations by some arbitrary variations δq_i , satisfying the following boundary conditions

$$\delta q_i(t_1) = \delta q_i(t_2) = 0 \quad (3.22)$$

summing over i , and integrating in time between t_1 and t_2 , we get

$$\int_{t_1}^{t_2} dt \left[\sum_{i=1}^N m_i \ddot{q}_i \delta q_i \right] = - \int_{t_1}^{t_2} dt \sum_{i=1}^N \delta q_i \frac{\partial V}{\partial q_i} \quad (3.23)$$

Integrating by parts

$$\delta \left\{ \int_{t_1}^{t_2} dt \left[\frac{1}{2} \sum_{i=1}^N m_i \dot{q}_i^2 - V \right] \right\} - \left[\sum_{i=1}^N m_i \dot{q}_i \delta q_i \right]_{t_1}^{t_2} = 0 \quad (3.24)$$

Using the boundary conditions we see that if the equations of motion are satisfied, than the lagrangian, as defined by

$$S = \int_{t_1}^{t_2} \left[\frac{1}{2} \sum_{i=1}^N m_i \dot{q}_i^2 - V \right] dt \quad (3.25)$$

is stationary. Conversely from the requirement that the action is stationary under variations satisfying eq. (3.22), the equations of motion follow. Analogously, in the Klein-Gordon case, we multiply the equation by arbitrary local variations of the field $\delta\phi(x) = \tilde{\phi}(x) - \phi(x)$, with boundary conditions

$$\delta\phi(x, t_1) = \delta\phi(x, t_2) = 0, \quad \lim_{\vec{x} \rightarrow \infty} \delta\phi(x, t) = 0 \quad (3.26)$$

then we integrate over time and space. After integrating by parts we find

$$0 = \int_{t_1}^{t_2} dt \int d^3x \left[\frac{\partial}{\partial t} (\dot{\phi} \delta\phi) - \dot{\phi} \delta\dot{\phi} - \vec{\nabla} \cdot (\vec{\nabla} \phi \delta\phi) + \vec{\nabla} \phi \cdot \vec{\nabla} \delta\phi + m^2 \phi \delta\phi \right] \quad (3.27)$$

Using the boundary conditions we get

$$0 = \delta \int_{t_1}^{t_2} dt \int d^3x \left[\frac{1}{2} \dot{\phi}^2 - \frac{1}{2} \vec{\nabla} \phi \cdot \vec{\nabla} \phi - \frac{1}{2} m^2 \phi^2 \right] \quad (3.28)$$

Therefore the lagrangian will be given by

$$L = \int d^3x \mathcal{L} \quad (3.29)$$

with

$$\mathcal{L} = \frac{1}{2} [\partial_\mu \phi \partial^\mu \phi - m^2 \phi^2] \quad (3.30)$$

In fact, we have just shown that the quantity (the action)

$$S = \int_{t_1}^{t_2} dt L \quad (3.31)$$

is stationary at the point in which the equations of motion are satisfied. We can now write down the canonical momentum density

$$\Pi = \frac{\partial \mathcal{L}}{\partial \dot{\phi}} = \dot{\phi} \quad (3.32)$$

and the canonical commutation relations

$$[\phi(x, t), \dot{\phi}(y, t)] = i\delta^3(x - y), \quad [\phi(x, t), \phi(y, t)] = [\dot{\phi}(x, t), \dot{\phi}(y, t)] = 0 \quad (3.33)$$

Let us now construct a complete set of solutions of the Klein-Gordon equation. First of all we need a scalar product. But we have already one, because we have shown in the previous Section that the Klein-Gordon equation admits a conserved quantity (see eq. (3.15)), therefore, if f and g are two solutions, the scalar product is

$$\langle f | g \rangle = i \int d^3x f^* \partial_t^{(-)} g \quad (3.34)$$

Let us now look for plane-wave solutions

$$f = A(k) e^{-ikx} = A(k) e^{-i(k_0 x_0 - \vec{k} \cdot \vec{x})} \quad (3.35)$$

From the wave equation we get

$$(\partial^2 + m^2)f = (-k^2 + m^2)f = 0 \quad (3.36)$$

from which

$$k^2 = m^2 \implies k_0^2 = |\vec{k}|^2 + m^2 \quad (3.37)$$

To fix the normalization, we proceed as in the one-dimensional case by taking a finite volume and requiring periodic boundary conditions (normalization in the box). By taking a cube of side L we require

$$\phi(x + L, y, z, t) = \phi(x, y + L, z, t) = \phi(x, y, z + L, t) = \phi(x, y, z, t) \quad (3.38)$$

it follows

$$\vec{k} = \frac{2\pi}{L} \vec{n} \quad (3.39)$$

where

$$\vec{n} = n_1 \vec{i}_1 + n_2 \vec{i}_2 + n_3 \vec{i}_3 \quad (3.40)$$

is a vector with integer components (n_1, n_2, n_3) . The normalization condition is

$$\langle f_{\vec{k}} | f_{\vec{k}'} \rangle = i \int_V d^3x f_{\vec{k}}^* \partial_t^{(-)} f_{\vec{k}'} = \delta_{\vec{k}, \vec{k}'} \quad (3.41)$$

where the **delta** is a Kronecker symbol defined as

$$\delta_{\vec{k}, \vec{k}'} = \prod_{i=1}^3 \delta_{n_i, n'_i} \quad (3.42)$$

with \vec{n} e \vec{n}' are two vectors with integer components, related to \vec{k} and \vec{k}' , by the relation (3.39). It follows

$$\int_V d^3x A_{\vec{k}}^* A_{\vec{k}'} e^{i(k_0 - k'_0)x_0 - i(\vec{k} - \vec{k}') \cdot \vec{x}} (k'_0 + k_0) = \delta_{\vec{k}, \vec{k}'} \quad (3.43)$$

Using

$$\int_L dx e^{i \frac{2\pi}{L} (n_1 - n'_1)x} = L \delta_{n_1, n'_1} \quad (3.44)$$

we get

$$\int_V d^3x e^{i(\vec{k} - \vec{k}') \cdot \vec{x}} = L^3 \delta_{\vec{k}, \vec{k}'} \quad (3.45)$$

from which

$$i \int_V d^3x f_{\vec{k}}^* \partial_t^{(-)} f_{\vec{k}'} = |A_{\vec{k}}|^2 2k_0 L^3 \delta_{\vec{k}, \vec{k}'} \quad (3.46)$$

where

$$k_0^2 = \left(\frac{2\pi}{L} \right)^2 |\vec{n}|^2 + m^2 \quad (3.47)$$

By considering, for the moment being, the positive solution of this equation, we obtain

$$A_{\vec{k}} = \frac{1}{L^{3/2}} \frac{1}{\sqrt{2\omega_k}}, \quad \omega_k = \sqrt{\left(\frac{2\pi}{L} \right)^2 |\vec{n}|^2 + m^2} = \sqrt{|\vec{k}|^2 + m^2} \quad (3.48)$$

and the normalized solution turns out to be

$$f_{\vec{k}}(x) = \frac{1}{L^{3/2}} \frac{1}{\sqrt{2\omega_k}} e^{-ikx} \quad (3.49)$$

Often we will make use also of the so called normalization in the continuum. The space integration is then extended to all of R^3 and we require

$$\langle f_{\vec{k}} | f_{\vec{k}'} \rangle = i \int d^3x f_{\vec{k}}^* \partial_t^{(-)} f_{\vec{k}'} = \delta^3(\vec{k} - \vec{k}') \quad (3.50)$$

In this case the spatial momentum can assume all the possible values in R^3 . It follows

$$\int d^3x A_{\vec{k}}^* A_{\vec{k}'} e^{ikx - ik'x} (k_0 + k'_0) = (2\pi)^3 \delta^3(\vec{k} - \vec{k}') |A_{\vec{k}}|^2 2k_0 \quad (3.51)$$

and the corresponding normalization is

$$A_{\vec{k}} = \frac{1}{\sqrt{(2\pi)^3}} \frac{1}{\sqrt{2\omega_k}} \quad (3.52)$$

where

$$\omega_k = \sqrt{|\vec{k}|^2 + m^2} \quad (3.53)$$

We see that one goes from the normalization in the box to the normalization in the continuum through the formal substitution

$$\frac{1}{\sqrt{V}} \rightarrow \frac{1}{\sqrt{(2\pi)^3}} \quad (3.54)$$

The wave function in the continuum is

$$f_{\vec{k}}(x) = \frac{1}{\sqrt{(2\pi)^3}} \frac{1}{\sqrt{2\omega_k}} e^{-ikx} \quad (3.55)$$

In both cases the dispersion relation

$$k_0^2 = |\vec{k}|^2 + m^2 \quad (3.56)$$

is obviously satisfied. But we have to remember that it has two solutions

$$k_0 = \pm \sqrt{|\vec{k}|^2 + m^2} = \pm \omega_k \quad (3.57)$$

As a consequence we get two kind of wave functions having positive and negative energy and behaving as $e^{-i\omega_k x_0}$ and $e^{i\omega_k x_0}$, $\omega_k > 0$, respectively. The second kind of solutions has negative norm in the scalar product we have defined. This would be a big problem if this equation had the same interpretation as the Schrödinger equation. In the field theory, no such a problem exists. In fact, the physical Hilbert space is the Fock space, where the scalar product is between the states build up in terms of creation and annihilation operators. Having two types of solutions the most general expansion for the field operator (in the Heisenberg representation) is

$$\phi(x) = \frac{1}{\sqrt{(2\pi)^3}} \int d^3k \frac{1}{\sqrt{2\omega_k}} \left[a(\vec{k}) e^{-i\omega_k x_0 + i\vec{k} \cdot \vec{x}} + \tilde{a}(\vec{k}) e^{i\omega_k x_0 + i\vec{k} \cdot \vec{x}} \right] \quad (3.58)$$

In the second term we can exchange $\vec{k} \rightarrow -\vec{k}$, obtaining ($kx = \omega_k x_0 - \vec{k} \cdot \vec{x}$)

$$\phi(x) = \frac{1}{\sqrt{(2\pi)^3}} \int d^3k \frac{1}{\sqrt{2\omega_k}} \left[a(\vec{k}) e^{-ikx} + \tilde{a}(-\vec{k}) e^{ikx} \right] \equiv \int d^3k [f_{\vec{k}} a(\vec{k}) + f_{\vec{k}}^* \tilde{a}(-\vec{k})] \quad (3.59)$$

Notice that the energy positive and negative solutions are orthogonal (remember the one-dimensional case discussed in Section 2.3). We can then invert the previous expansion with the result

$$a(\vec{k}) = i \int d^3x f_{\vec{k}}^*(x) \partial_t^{(-)} \phi(x), \quad \tilde{a}(-\vec{k}) = i \int d^3x \phi(x) \partial_t^{(-)} f_{\vec{k}}(x) \quad (3.60)$$

If $\phi(x)$ is a hermitian Klein-Gordon field, we have

$$\tilde{a}(-\vec{k}) = a^\dagger(\vec{k}) \quad (3.61)$$

and the expansion becomes

$$\phi(x) = \int d^3k [f_{\vec{k}}(x) a(\vec{k}) + f_{\vec{k}}^*(x) a^\dagger(\vec{k})] \quad (3.62)$$

From these equations one can evaluate the commutators among the operators $a(\vec{k})$ e $a^\dagger(\vec{k})$, obtaining

$$[a(\vec{k}), a^\dagger(\vec{k}')] = \delta^3(\vec{k} - \vec{k}') \quad (3.63)$$

$$[a(\vec{k}), a(\vec{k}')] = [a^\dagger(\vec{k}), a^\dagger(\vec{k}')] = 0 \quad (3.64)$$

These commutation relations depend on the normalization defined for the $f_{\vec{k}}$'s. For instance, if we change this normalization by a factor $N_{\vec{k}}$

$$\langle f_{\vec{k}} | f_{\vec{k}'} \rangle = i \int d^3x f_{\vec{k}}^* \partial_t^{(-)} f_{\vec{k}'} = N_{\vec{k}} \delta^3(\vec{k} - \vec{k}') \quad (3.65)$$

leaving unchanged the expansion for the field

$$\phi = \int d^3k [f_{\vec{k}} a(\vec{k}) + f_{\vec{k}}^* a^\dagger(\vec{k})] \quad (3.66)$$

we get

$$a(\vec{k}) = \frac{i}{N_{\vec{k}}} \int d^3x f_{\vec{k}}^* \partial_t^{(-)} \phi, \quad a^\dagger(\vec{k}) = \frac{i}{N_{\vec{k}}} \int d^3x \phi \partial_t^{(-)} f_{\vec{k}} \quad (3.67)$$

and therefore

$$[a(\vec{k}), a^\dagger(\vec{k}')] = \frac{i}{N_{\vec{k}} N_{\vec{k}'}} \int d^3x f_{\vec{k}}^* \partial_t^{(-)} f_{\vec{k}'} = \frac{1}{N_{\vec{k}}} \delta^3(\vec{k} - \vec{k}') \quad (3.68)$$

For instance, a normalization which is used very often is the covariant one

$$\phi(x) = \frac{1}{(2\pi)^3} \int d^3k \frac{1}{2\omega_k} [A(\vec{k}) e^{-ikx} + A^\dagger(\vec{k}) e^{ikx}] \quad (3.69)$$

The name comes from the fact that the factor $1/2\omega_k$ makes the integration over the three-momentum Lorentz invariant. In fact one has

$$\frac{1}{(2\pi)^3} \int d^3k \frac{1}{2\omega_k} = \frac{1}{(2\pi)^4} \int d^4k (2\pi) \delta(k^2 - m^2) \theta(k_0) \quad (3.70)$$

as it follows by noticing that for $k_0 \approx \omega_k$

$$k^2 - m^2 \approx 2\omega_k(k_0 - \sqrt{|\vec{k}|^2 + m^2}) \quad (3.71)$$

In this case the basis functions for the expansion are

$$f_{\vec{k}}(x) = \frac{1}{(2\pi)^3} \frac{1}{2\omega_k} e^{-ikx} \quad (3.72)$$

with normalization

$$i \int d^3x f_{\vec{k}}^* \partial_t^{(-)} f_{\vec{k}'} = \frac{1}{(2\pi)^3} \frac{1}{2\omega_k} \delta^3(\vec{k} - \vec{k}') \quad (3.73)$$

and therefore

$$[A(\vec{k}), A^\dagger(\vec{k}')] = (2\pi)^3 2\omega_k \delta^3(\vec{k} - \vec{k}') \quad (3.74)$$

3.3 The Noether's theorem for relativistic fields

We will now review the Noether's theorem. This allows to relate symmetries of the action with conserved quantities. More precisely, given a transformation involving both the fields and the coordinates, if it happens that the action is invariant under this transformation, then a conservation law follows. When the transformations are limited to the fields one speaks about **internal transformations**. When both types of transformations are involved, it is convenient to evaluate, in general, the variation of a local quantity $F(x)$ (that is a function of the space-time point)

$$\begin{aligned} \Delta F(x) &= \tilde{F}(x') - F(x) = \tilde{F}(x + \delta x) - F(x) \\ &\cong \tilde{F}(x) - F(x) + \delta x^\mu \frac{\partial F(x)}{\partial x^\mu} \end{aligned} \quad (3.75)$$

The total variation Δ keeps into account both the variation of the reference frame and the form variation of F . It is then convenient to define a **local** variation δF , depending only on the form variation

$$\delta F(x) = \tilde{F}(x) - F(x) \quad (3.76)$$

Then we get

$$\Delta F(x) = \delta F(x) + \delta x^\mu \frac{\partial F(x)}{\partial x^\mu} \quad (3.77)$$

Let us now start from a generic four-dimensional action

$$S = \int_V d^4x \mathcal{L}(\phi^i, x), \quad i = 1, \dots, N \quad (3.78)$$

and let us consider a generic variation of the fields and of the coordinates, $x'^\mu = x^\mu + \delta x^\mu$

$$\Delta \phi^i(x) = \tilde{\phi}^i(x') - \phi^i(x) \approx \delta \phi^i(x) + \delta x^\mu \frac{\partial \phi^i}{\partial x^\mu} \quad (3.79)$$

If the action is invariant under the transformation, then

$$\tilde{S}_{V'} = S_V \quad (3.80)$$

The variation of S under the transformation (3.79) is given by (here $\partial_\mu = \partial/\partial x^\mu$ and $\phi^i_{,\mu} = \partial\phi^i/\partial x^\mu$)

$$\begin{aligned} \delta S_V &= \int_{V'} d^4x' \tilde{\mathcal{L}}(\tilde{\phi}^i, x') - \int_V d^4x \mathcal{L}(\phi^i, x) \\ &= \int_V d^4x \tilde{\mathcal{L}}(\tilde{\phi}^i, x + \delta x) \frac{\partial(x')}{\partial(x)} - \int_V d^4x \mathcal{L}(\phi^i, x) \\ &\approx \int_V d^4x \tilde{\mathcal{L}}(\tilde{\phi}^i, x + \delta x) (1 + \partial_\mu \delta x^\mu) - \int_V d^4x \mathcal{L}(\phi^i, x) \\ &= \int_V d^4x [\tilde{\mathcal{L}}(\tilde{\phi}^i, x + \delta x) - \mathcal{L}(\phi^i, x)] + \int_V d^4x \mathcal{L}(\phi^i, x) \partial_\mu \delta x^\mu \\ &\approx \int_V d^4x \left[\frac{\partial \mathcal{L}}{\partial \phi^i} \delta \phi^i + \frac{\partial \mathcal{L}}{\partial \phi^i_{,\mu}} \delta \phi^i_{,\mu} + \frac{\partial \mathcal{L}}{\partial x^\mu} \delta x^\mu \right] + \int_V d^4x \mathcal{L} \partial_\mu \delta x^\mu \\ &= \int_V d^4x \left[\frac{\partial \mathcal{L}}{\partial \phi^i} - \partial_\mu \frac{\partial \mathcal{L}}{\partial \phi^i_{,\mu}} \right] \delta \phi^i + \int_V d^4x \partial_\mu \left[\mathcal{L} \delta x^\mu + \frac{\partial \mathcal{L}}{\partial \phi^i_{,\mu}} \delta \phi^i \right] \quad (3.81) \end{aligned}$$

The first term in the last line is zero due to the Euler-Lagrange equations of motion

$$\frac{\partial \mathcal{L}}{\partial \phi^i} - \partial_\mu \frac{\partial \mathcal{L}}{\partial \phi^i_{,\mu}} = 0 \quad (3.82)$$

Therefore, if the action is invariant under the transformation under consideration, using eq. (3.79), we get

$$\int_V d^4x \partial_\mu \left[\mathcal{L} \delta x^\mu + \frac{\partial \mathcal{L}}{\partial \phi^i_{,\mu}} \Delta \phi^i - \delta x^\nu \frac{\partial \mathcal{L}}{\partial \phi^i_{,\mu}} \phi^i_{,\nu} \right] = 0 \quad (3.83)$$

This is the general result expressing the local conservation of the quantity in parenthesis. According to the choice one does for the variations δx^μ and $\Delta \phi^i$, and of the corresponding symmetries of the action, one gets different kind of conserved quantities.

Let us start with an action invariant under space and time translations. In the case we take $\delta x^\mu = a^\mu$ with a^μ independent on x and $\Delta \phi^i = 0$. From the general result in eq. (3.83) we get the following local conservation law

$$T_\nu^\mu = \frac{\partial \mathcal{L}}{\partial \phi^i_{,\mu}} \phi^i_{,\nu} - \mathcal{L} g_\nu^\mu, \quad \partial_\mu T_\nu^\mu = 0 \quad (3.84)$$

$T_{\mu\nu}$ is called the energy-momentum tensor of the system. From its local conservation we get four constant of motion

$$P_\nu = \int d^3x T_\nu^0 \quad (3.85)$$

P_μ is the four-momentum of the system. In the case of internal symmetries we take $\delta x^\mu = 0$. The conserved current will be

$$J^\mu = \frac{\partial \mathcal{L}}{\partial \phi^i_{,\mu}} \Delta \phi^i = \frac{\partial \mathcal{L}}{\partial \phi^i_{,\mu}} \delta \phi^i, \quad \partial_\mu J^\mu = 0 \quad (3.86)$$

with an associated constant of motion given by

$$Q = \int d^3x J^0 \quad (3.87)$$

In general, if the system has more than one internal symmetry, we may have more than one conserved charge Q , that is we have a conserved charge for any Δ .

The last case we will consider is the invariance with respect to Lorentz transformations. Let us recall that they are defined as the transformations leaving invariant the norm of a four-vector

$$x^2 = x'^2 \quad (3.88)$$

For an infinitesimal transformation

$$x' = x + \delta x \quad (3.89)$$

it follows

$$x^2 \approx x'^2 + 2x \cdot \delta x \implies x \cdot \delta x = 0 \quad (3.90)$$

Since Lorentz transformations are linear

$$x'_\mu = \Lambda_{\mu\nu} x^\nu \approx x_\mu + \epsilon_{\mu\nu} x^\nu \quad (3.91)$$

we get

$$x \cdot \delta x = 0 \implies x^\mu \epsilon_{\mu\nu} x^\nu = 0 \quad (3.92)$$

The most general solution for the parameters $\epsilon_{\mu\nu}$ of the transformation is that they form an antisymmetric second order tensor

$$\epsilon_{\mu\nu} = -\epsilon_{\nu\mu} \quad (3.93)$$

We see that the number of independent parameters characterizing a Lorentz transformation is six. As well known, three of them correspond to spatial rotations, whereas the remaining three correspond to Lorentz boosts. In general, the relativistic fields are chosen to belong to a representation of the Lorentz group (for instance the Klein-Gordon field belongs to the scalar representation). This means that under a Lorentz transformation the components of the field mix together, as, for instance, a vector field does under rotations. Therefore, the transformation law of the fields ϕ^i under an infinitesimal Lorentz transformation can be written as

$$\Delta \phi^i = -\frac{1}{2} \sum_{\mu\nu}^{ij} \epsilon^{\mu\nu} \phi^j \quad (3.94)$$

where we have required that the transformation of the fields is of first order in the Lorentz parameters $\epsilon_{\mu\nu}$. The coefficients $\Sigma_{\mu\nu}$ (antisymmetric in the indices (μ, ν)) define a matrix in the indices (i, j) which can be shown to be the representative of the infinitesimal generators of the Lorentz group in the field representation. Using this equation and the expression for δx_μ we get the local conservation law

$$\begin{aligned} 0 &= \partial_\mu \left[\left(\frac{\partial \mathcal{L}}{\partial \phi^i_{,\mu}} \phi^i_{,\nu} - \mathcal{L} g_\nu^\mu \right) \epsilon^{\nu\rho} x_\rho + \frac{1}{2} \frac{\partial \mathcal{L}}{\partial \phi^i_{,\mu}} \Sigma_{\nu\rho}^{ij} \epsilon^{\nu\rho} \phi^j \right] \\ &= \frac{1}{2} \epsilon^{\nu\rho} \partial_\mu \left[\left(T_\nu^\mu x_\rho - T_\rho^\mu x_\nu \right) + \frac{\partial \mathcal{L}}{\partial \phi^i_{,\mu}} \Sigma_{\nu\rho}^{ij} \phi^j \right] \end{aligned} \quad (3.95)$$

and defining (watch at the change of sign)

$$\mathcal{M}_{\rho\nu}^\mu = x_\rho T_\nu^\mu - x_\nu T_\rho^\mu - \frac{\partial \mathcal{L}}{\partial \phi^i_{,\mu}} \Sigma_{\rho\nu}^{ij} \phi^j \quad (3.96)$$

it follows the existence of six locally conserved currents (one for each Lorentz transformation)

$$\partial_\mu \mathcal{M}_{\nu\rho}^\mu = 0 \quad (3.97)$$

and consequently six constants of motion (notice that the lower indices are antisymmetric)

$$M_{\nu\rho} = \int d^3x \mathcal{M}_{\nu\rho}^0 \quad (3.98)$$

Three of these constants (the ones with ν and ρ assuming spatial values) are nothing but the components of the angular momentum of the field.

In the case of Klein-Gordon

$$T_{\mu\nu} = \partial_\mu \phi \partial_\nu \phi - \frac{1}{2} \left(\partial_\rho \phi \partial^\rho \phi - m^2 \phi^2 \right) g_{\mu\nu} \quad (3.99)$$

from which

$$T_0^0 = \frac{1}{2} \dot{\phi}^2 + \frac{1}{2} \left(|\vec{\nabla} \phi|^2 + m^2 \phi^2 \right) \quad (3.100)$$

This current corresponds to the invariance under time translations, and it must be identified with the energy density of the field (compare with the equation (2.55 for the one-dimensional case). In analogous way

$$T_i^0 = \dot{\phi} \frac{\partial \phi}{\partial x^i} \quad (3.101)$$

is the momentum density of the field. Using $\dot{\phi} = \Pi$, the energy and momentum of the Klein-Gordon field can be written in the form

$$P^0 = H = \int d^3x T^{00} = \frac{1}{2} \int d^3x \left(\Pi^2 + |\vec{\nabla} \phi|^2 + m^2 \phi^2 \right) \quad (3.102)$$

$$P^i = \int d^3x T^{0i} = - \int d^3x \Pi \frac{\partial \phi}{\partial x^i}, \quad (\vec{P} = - \int d^3x \Pi \vec{\nabla} \phi) \quad (3.103)$$

3.4 Energy and momentum of the Klein-Gordon field

It is very easy to verify that the energy density found previously coincides with the hamiltonian density evaluated in the canonical way through the Legendre transformation of the lagrangian density

$$\mathcal{H} = \Pi\dot{\phi} - \mathcal{L} \quad (3.104)$$

We will verify now, that the momentum P^μ is the generator, as it should be, of the space-time translations. Which amounts to say that it satisfies the following commutation relation with the field

$$[\phi(x), P^\mu] = i \frac{\partial \phi}{\partial x_\mu} \quad (3.105)$$

In fact

$$[\phi(\vec{y}, t), H] = \frac{1}{2} \int d^3x [\phi(\vec{y}, t), \Pi^2(\vec{x}, t)] = i\Pi(\vec{y}, t) = i\dot{\phi}(\vec{y}, t) \quad (3.106)$$

Analogously

$$[\phi(\vec{y}, t), P^i] = - \int d^3x [\phi(\vec{y}, t), \Pi(\vec{x}, t) \frac{\partial \phi(\vec{x}, t)}{\partial x^i}] = -i \frac{\partial \phi(\vec{y}, t)}{\partial y^i} = i \frac{\partial \phi(\vec{y}, t)}{\partial y_i} \quad (3.107)$$

Therefore the operator

$$U = e^{ia^\mu P_\mu} \quad (3.108)$$

generates translations in x . In fact, by looking at the first order in a^μ , it follows

$$e^{ia \cdot P} \phi(x) e^{-ia \cdot P} \approx \phi(x) + ia^\mu [P_\mu, \phi(x)] = \phi(x) + a^\mu \frac{\partial \phi(x)}{\partial x^\mu} \approx \phi(x + a) \quad (3.109)$$

With a calculation completely analogue to the one done in Section 2.3 we can evaluate the hamiltonian and the momentum in terms of the creation and annihilation operators

$$H = \frac{1}{2} \int d^3k \omega_k [a^\dagger(\vec{k})a(\vec{k}) + a(\vec{k})a^\dagger(\vec{k})] \quad (3.110)$$

$$\vec{P} = \int d^3k \vec{k} a^\dagger(\vec{k})a(\vec{k}) \quad (3.111)$$

They satisfy the following commutation relations with $a^\dagger(\vec{k})$

$$[H, a^\dagger(\vec{k})] = \omega_k a^\dagger(\vec{k}), \quad [P, a^\dagger(\vec{k})] = \vec{k} a^\dagger(\vec{k}) \quad (3.112)$$

This shows that the operators $a^\dagger(\vec{k})$, acting on the vacuum, create states of momentum \vec{k} and energy $\omega_k = \sqrt{|\vec{k}|^2 + m^2}$, whereas the annihilation operators $a(\vec{k})$ destroy

the corresponding states. In the case of the box normalization, for any $\vec{k} = (2\pi/L)\vec{n}$ (that is for any choice of the three integer components of the vector \vec{n} , (n_1, n_2, n_3)), one can build up a state $|n_{\vec{k}}\rangle$ such that

$$|n_{\vec{k}}\rangle = \frac{1}{\sqrt{n_{\vec{k}}!}} (a^\dagger(\vec{k}))^{n_{\vec{k}}} |0\rangle \quad (3.113)$$

contains $n_{\vec{k}}$ particles of momentum \vec{k} . The most general state is obtained by tensor product of states similar to the previous one. Any of these states is characterized by a triple of integers defining the momentum \vec{k} , that is

$$|n_{\vec{k}_1} \dots n_{\vec{k}_\alpha}\rangle = \prod_{\otimes} |n_{\vec{k}_i}\rangle = \frac{1}{\sqrt{n_{\vec{k}_1}! \dots n_{\vec{k}_\alpha}!}} (a^\dagger(\vec{k}_1))^{n_{\vec{k}_1}} \dots (a^\dagger(\vec{k}_\alpha))^{n_{\vec{k}_\alpha}} |0\rangle \quad (3.114)$$

The fundamental state is the one with zero particles in any cell of the momentum space (vacuum state)

$$|0\rangle = \prod_{\otimes} |0\rangle_i \quad (3.115)$$

where $|0\rangle_i$ is the fundamental state for the momentum in the cell i . That is

$$a_{\vec{k}_i} |0\rangle_i = 0 \quad (3.116)$$

In this normalization the hamiltonian is given by

$$H = \frac{1}{2} \sum_{\vec{k}} \omega_k [a^\dagger(\vec{k})a(\vec{k}) + a(\vec{k})a^\dagger(\vec{k})] \quad (3.117)$$

and therefore

$$H|0\rangle = \frac{1}{2} \sum_{\vec{k}} \omega_k |0\rangle \quad (3.118)$$

This sum is infinite. Recalling that $\vec{k} = (2\pi/L)\vec{n}$, it follows that the cell in the \vec{k} -space has a volume

$$\Delta V_{\vec{k}} = \frac{(2\pi)^3}{L^3} \quad (3.119)$$

from which

$$\frac{1}{2} \sum_{\vec{k}} \omega_k = \frac{1}{2} \sum_{\vec{k}} \frac{\Delta V_{\vec{k}} \omega_k}{\Delta V_{\vec{k}}} \implies \frac{1}{2} \frac{L^3}{(2\pi)^3} \int d^3k \sqrt{|\vec{k}|^2 + m^2} \quad (3.120)$$

which is divergent.

Let us recall that this problem can be formally avoided through the use of the normal product. In other words by subtracting the infinite energy of the vacuum from the hamiltonian. In the box normalization we have

$$: H := \sum_{\vec{k}} \omega_k a^\dagger(\vec{k})a(\vec{k}) \quad (3.121)$$

whereas in the continuum

$$: H := \int d^3k \omega_k a^\dagger(\vec{k}) a(\vec{k}) \quad (3.122)$$

As we see, the energy of the vacuum depends on the quantization volume. This implies that it depends on the boundary conditions of the problem. In the real vacuum this is not a difficulty, but it must be considered when one quantize fields which are inside a finite given volume. In this case this dependence produces measurable effects, as it was pointed out theoretically by Casimir in 1948, and then proved experimentally by Sparnay in 1958.

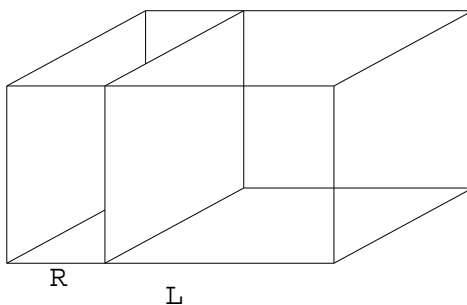

Fig. 3.1 - The Casimir effect

We will discuss very briefly the Casimir effect arising when we have an electromagnetic field confined between two large perfectly conducting plates. We idealize the two plates as two large parallel squares of side L at a distance $R \ll L$. The theory shows that there is an attractive force per unit surface between the two plates given by

$$p = -\frac{\pi^2}{240} \frac{\hbar c}{R^4} = -\frac{0.013}{(R_{\mu m})^4} \text{ dyn/cm}^2 \quad (3.123)$$

We can understand the origin of this force in a very qualitative way by quantizing the electromagnetic field (that we will take here as a Klein-Gordon field with zero mass, $m = 0$) in a box of side L . The vacuum energy will be

$$E_0 \approx L^3 \int_{1/L}^{k_{max}} k d^3k \quad (3.124)$$

with the integration between a lower momentum of order $1/L$ and an arbitrary upper momentum which is necessary in order to make finite the integral. If we insert two plates of side L , as shown in Fig. 3.1, at a distance R , the energy of the field in this region, before the introduction of the plates is

$$E \approx L^2 R \int_{1/L}^{k_{max}} k d^3k \quad (3.125)$$

When we insert the plates we get an analogous result, but the lower momentum will be of order $1/R$. therefore the variation of the energy results to be

$$\Delta E \approx L^2 R \int_{1/R}^{1/L} k d^3 k = L^2 R \int_{1/R}^{1/L} k^3 dk = \frac{L^2 R}{4} \left[\left(\frac{1}{L} \right)^4 - \left(\frac{1}{R} \right)^4 \right] \quad (3.126)$$

Therefore, for $R \ll L$, we get

$$\Delta E \approx -\frac{L^2}{R^3} \quad (3.127)$$

The energy per unit surface behaves as $1/R^3$, and the pressure is given by

$$p \approx -\frac{\partial \Delta E / L^2}{\partial R} \approx -\frac{1}{R^4} \quad (3.128)$$

3.5 Locality and causality in field theory

For a free particle there are generally three conserved quantum numbers, as the spatial momentum, or energy, angular momentum and its third component. All these quantities can be expressed as spatial integrals of **local** functions of the fields. The locality property is a crucial one and is connected with the causality. To understand this point let us consider the following example. For a Klein-Gordon free field there is a further constant of motion, the number of particles

$$N = \int d^3 k a^\dagger(\vec{k}) a(\vec{k}) \quad (3.129)$$

We will show now that this cannot be written as the spatial integral of a local quantity, and that this implies the non observability of the quantity number of particles. We know that, apart the energy momentum tensor, the Klein-Gordon theory admits a further conserved current

$$J_\mu = \phi^\dagger (\partial_\mu \phi) - (\partial_\mu \phi^\dagger) \phi \quad (3.130)$$

However this expression vanishes for a hermitian field. But it turns out that the operator N can be expressed in terms of the positive energy

$$\phi^{(+)}(x) = \int d^3 k \frac{1}{\sqrt{2\omega_k (2\pi)^3}} e^{-i(\omega_k t - \vec{k} \cdot \vec{x})} a(\vec{k}) \quad (3.131)$$

and negative energy components of the field

$$\phi^{(-)}(x) = \phi^{(+)\dagger}(x) \quad (3.132)$$

In fact, it is not difficult to show that

$$N = \int d^3 x \phi^{(+)} i \partial_t^{(-)} \phi^{(-)} \quad (3.133)$$

This is a constant of motion, because both $\phi^{(+)}$ and $\phi^{(-)}$ are solutions of the equation of motion, and therefore

$$j_\mu = \phi^{(-)}(\partial_\mu \phi^{(+)}) - (\partial_\mu \phi^{(-)})\phi^{(+)} \quad (3.134)$$

is a conserved current. However this current is not a local expression in the field ϕ . This is because $\phi^{(+)}$ and $\phi^{(-)}$ are not local functions of ϕ . In fact, in order to project out these components from the field we need a time integration. In fact, by defining

$$\phi(x) = \int d^4k \phi(k) e^{-ikx} \quad (3.135)$$

with

$$\phi(k) = \sqrt{\frac{2\omega_k}{(2\pi)^3}} \delta(k^2 - m^2) \left(a(k)\theta(k_0) + a^\dagger(k)\theta(-k_0) \right) \quad (3.136)$$

one has

$$\phi^{(+)}(x) = \int d^4k \phi^{(+)}(k) e^{-ikx} \quad (3.137)$$

with

$$\phi^{(+)}(k) = \theta(k_0)\phi(k) \quad (3.138)$$

Using the convolution theorem for the Fourier transform we get

$$\phi^{(+)}(x) = \int d^4x' \tilde{\theta}(x - x') \phi(x') \quad (3.139)$$

But

$$\begin{aligned} \tilde{\theta}(x - x') &= \frac{1}{(2\pi)^4} \int d^4k e^{ik(x - x')} \theta(k_0) \\ &= \delta^3(\vec{x} - \vec{x}') \int \frac{dk_0}{2\pi} e^{ik_0(x_0 - x'_0)} \theta(k_0) \\ &= \delta^3(\vec{x} - \vec{x}') \tilde{\theta}(x_0 - x'_0) \end{aligned} \quad (3.140)$$

Therefore

$$\phi^{(+)}(\vec{x}, x_0) = \int dx'_0 \tilde{\theta}(x_0 - x'_0) \phi(\vec{x}, x'_0) \quad (3.141)$$

To show the implications of having to do with a non local current, let us define a particle density operator

$$\mathcal{N}(x) = i\phi^{(+)}\partial_t^{(-)}\phi^{(-)} \quad (3.142)$$

This operator does not commute with itself at equal times and different space points

$$[\mathcal{N}(\vec{x}, t), \mathcal{N}(\vec{y}, t)] \neq 0, \quad \vec{x} \neq \vec{y} \quad (3.143)$$

However, for local operators, $\mathcal{O}(\phi)$, this commutator is automatically zero, due to the canonical commutation relations

$$[\mathcal{O}(\phi(\vec{x}, t)), \mathcal{O}(\phi(\vec{y}, t))] = 0, \quad \forall \vec{x} \neq \vec{y} \quad (3.144)$$

We want to argue that the vanishing of this commutator is just the necessary condition in order that \mathcal{O} represents an observable quantity. In fact, if the commutator of a local operator with itself is not zero at space-like distances, then the measure of the observable at some point, x , would influence the measures done at points with space-like separation from x , because we cannot measure the operator simultaneously at two such points. But this would imply the propagation of a signal at a velocity greater than the light velocity, in contrast with the causality principle. We see that the vanishing of the commutator of a local observable with itself at space-like distances is a necessary condition in order to satisfy the causality principle. We show now that this is automatically satisfied if the operator under consideration is a local function of the fields. We will start showing that the commutator of the field with itself is a Lorentz invariant function. Therefore, from the vanishing of the commutator for separations between points of the type $x^\mu = (t, \vec{x})$, and $y^\mu = (t, \vec{y})$, it follows the vanishing for arbitrary space-like separations. Let us evaluate the commutator

$$\begin{aligned}
[\phi(x), \phi(y)] &= \\
&= \int \frac{d^3 k_1 d^3 k_2}{(2\pi)^3 \sqrt{2\omega_{k_1} 2\omega_{k_2}}} \left[[a(\vec{k}_1), a^\dagger(\vec{k}_2)] e^{-ik_1 x + ik_2 y} \right. \\
&+ \left. [a^\dagger(\vec{k}_1), a(\vec{k}_2)] e^{ik_1 x - ik_2 y} \right] \\
&= \int \frac{d^3 k}{(2\pi)^3 2\omega_k} \left[e^{-ik(x-y)} - e^{ik(x-y)} \right] \\
&= -2i \int \frac{d^3 k}{(2\pi)^3 2\omega_k} \sin(\omega_k(x_0 - y_0)) e^{i\vec{k}(\vec{x} - \vec{y})} \quad (3.145)
\end{aligned}$$

Using eq. (3.70), this expression can be written in invariant form

$$\begin{aligned}
[\phi(x), \phi(y)] &= \int \frac{d^4 k}{(2\pi)^3} \theta(k_0) \delta(k^2 - m^2) \left[e^{-ik(x-y)} - e^{ik(x-y)} \right] \\
&= \int \frac{d^4 k}{(2\pi)^3} \epsilon(k_0) \delta(k^2 - m^2) e^{-ik(x-y)} \quad (3.146)
\end{aligned}$$

Since the sign of the fourth component of a time-like fourvector is invariant under proper Lorentz transformations, we see that by putting

$$[\phi(x), \phi(y)] = i\Delta(x-y) \quad (3.147)$$

the function

$$\Delta(x-y) = -i \int \frac{d^4 k}{(2\pi)^3} \epsilon(k_0) \delta(k^2 - m^2) e^{-ik(x-y)} \quad (3.148)$$

is Lorentz invariant and, as such, it depends only on $(x-y)^2$. Since $\Delta(x-y)$ vanishes at equal times, it follows that it is zero for arbitrary space-like separations.

Therefore the canonical commutation relations make sure the observability for the Klein-Gordon field. For the negative and positive energy components we get

$$\begin{aligned}
[\phi^{(+)}(x), \phi^{(-)}(y)] &= \int \frac{d^3k}{(2\pi)^3 2\omega_k} e^{-ik(x-y)} \\
&= \int \frac{d^4k}{(2\pi)^3} \theta(k_0) \delta(k^2 - m^2) e^{-ik(x-y)} \\
&\equiv \Delta^{(+)}(x-y)
\end{aligned} \tag{3.149}$$

Also in this case we have a Lorentz invariant function, and therefore it is enough to study its equal times behaviour:

$$\begin{aligned}
\Delta^{(+)}(0, \vec{x}) &= \int \frac{d^3k}{(2\pi)^3 2\omega_k} e^{i\vec{k} \cdot \vec{x}} \\
&= \int \frac{k^2 dk d(\cos \theta) d\varphi}{(2\pi)^3 2\omega_k} e^{ikr \cos \theta} \\
&= -i \frac{1}{4\pi^2 r} \int_0^\infty \frac{k dk}{2\omega_k} \left[e^{ikr} - e^{-ikr} \right] \\
&= -\frac{1}{8\pi^2 r} \frac{d}{dr} \int_{-\infty}^{+\infty} dk \frac{e^{ikr}}{\sqrt{|\vec{k}|^2 + m^2}}
\end{aligned} \tag{3.150}$$

By putting $k = m \sinh \theta$, $dk = m \cosh \theta d\theta$, we get

$$\Delta^{(+)}(0, \vec{x}) = -\frac{1}{8\pi^2 r} \frac{d}{dr} \int_{-\infty}^{+\infty} d\theta e^{imr \sinh \theta} \tag{3.151}$$

Since

$$\int_{-\infty}^{+\infty} d\theta e^{imr \sinh \theta} = i\pi H_0^{(1)}(imr) \tag{3.152}$$

where H is a Hankel's function, and using

$$\frac{d}{dr} H_0^{(1)}(imr) = -im H_1^{(1)}(imr) \tag{3.153}$$

we obtain

$$\Delta^{(+)}(0, \vec{x}) = -\frac{m}{8\pi r} H_1^{(1)}(imr) \tag{3.154}$$

The asymptotic behaviour of the Hankel's function $H_1^{(1)}(imr)$ for large and small values of r is given by

$$\lim_{r \rightarrow \infty} H_1^{(1)}(imr) \approx -\sqrt{\frac{2}{\pi m r}} e^{-mr}, \quad \lim_{r \rightarrow 0} H_1^{(1)}(imr) \approx -\frac{2}{mr} \tag{3.155}$$

from which

$$\lim_{r \rightarrow \infty} \Delta^{(+)}(0, \vec{x}) \approx \frac{m}{8\pi r} \sqrt{\frac{2}{\pi m r}} e^{-mr}, \quad \lim_{r \rightarrow 0} \Delta^{(+)}(0, \vec{x}) \approx \frac{1}{4\pi r^2} \tag{3.156}$$

We see that for space-like separations this commutator does not vanish. But for space separations larger than the Compton wave length $1/m$, $\Delta^{(+)}$ is practically zero. Remember that for an electron the Compton wave length is about $3.9 \cdot 10^{-11}$ cm. Clearly, an analogous result is obtained for the commutator of the particle density operator. From this we can derive the impossibility of localize a Klein-Gordon particle (but the result can be extended to any relativistic particle) over distances of the order of $1/m$. We start defining the following operators

$$N(V) = \int_V d^3x \mathcal{N}(x) \quad (3.157)$$

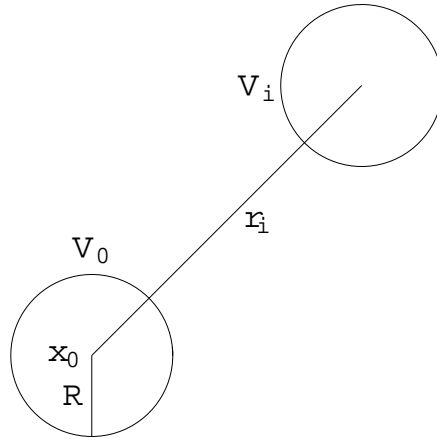

Fig. 3.2 - In order to localize a particle inside V_0 , there should be no other particles within a distance $r_i \approx R$

where V is a sphere in the three dimensional space. Suppose we want to localize the particle around a point x_0 with an uncertainty R . We consider a sphere V_0 centered at x_0 with radius R . We then take other spheres V_i not connected to V_0 , that is with center separated by x_0 by a distance $r_i > R$, as shown in Fig. 3.2. The requirement to localize the particle within V_0 , with a radius $R < 1/m$, is equivalent to ask for the existence of a state with eigenvalue 1 for the operator $N(V_0)$ and eigenvalues 0 for all the $N(V_i)$ with $r_i \approx 1/m$. But such an eigenstate does not exist because, as we have shown previously $[N(V_0), N(V_i)] \neq 0$. On the contrary, if we take volumes V_i at distances r_i much bigger than $1/m$, the corresponding operators $N(V_i)$ commute, and we can construct the desired state. Therefore it is possible to localize the particle only over distances much bigger than the Compton wave length. The physical explanation is that to realize the localization over distances much smaller than $1/m$, we need energies much bigger than m . But in this case there is a non zero probability to create particle antiparticle pairs.

To summarize, in order to make a local quantity an observable, it is necessary that once commuted with itself, the result vanishes at space-like distances, otherwise we violate the causality principle. If the quantity is a local function of the fields,

the previous condition is automatically satisfied due to the canonical commutation relations. A relativistic particle cannot be localized over distances of the order of $1/m$, because the particle density is not a local function of the fields. From these considerations we see also that the components with negative energy of the fields are essential for the internal consistency of the theory. Otherwise the particle interpretation of the field (that is the commutation relations among creation and annihilation operators) and the locality properties (vanishing of the commutators at space-like distances) would not be compatible.

3.6 The charged scalar field

We have shown that a hermitian Klein-Gordon field describes a set of identical scalar particles. If we want to describe different kind of particles we need to introduce different kind of fields. Let us begin with two different hermitian scalar fields. The free lagrangian is a simple sum

$$\mathcal{L} = \frac{1}{2} \sum_{i=1}^2 [(\partial_\mu \phi_i)(\partial^\mu \phi_i) - m_i^2 \phi_i^2] \quad (3.158)$$

and we can write immediately the canonical commutation relations

$$[\phi_i(\vec{x}, t), \dot{\phi}_j(\vec{y}, t)] = i\delta_{ij}\delta^3(\vec{x} - \vec{y}) \quad (3.159)$$

$$[\phi_i(\vec{x}, t), \phi_j(\vec{y}, t)] = [\dot{\phi}_i(\vec{x}, t), \dot{\phi}_j(\vec{y}, t)] = 0 \quad (3.160)$$

All the considerations done up to now can be easily extended to the case of two fields. However we notice that there are two kind of creation and annihilation operators, $a_i^\dagger(\vec{k})$, $i = 1, 2$, and as a consequence

$$a_1^\dagger(\vec{k}_1)a_2^\dagger(\vec{k}_2)|0\rangle \neq a_2^\dagger(\vec{k}_1)a_1^\dagger(\vec{k}_2)|0\rangle \quad (3.161)$$

The two particle state is not any more symmetric, since it is built up in terms of two different types of creation operators. That means that the two fields correspond to distinguishable particles.

Something really new comes out when the two fields have the same mass term in the lagrangian

$$\mathcal{L} = \frac{1}{2} [(\partial_\mu \phi_1)(\partial^\mu \phi_1) + (\partial_\mu \phi_2)(\partial^\mu \phi_2)] - \frac{1}{2}m^2 [\phi_1^2 + \phi_2^2] \quad (3.162)$$

Then the theory acquires a symmetry under rotations in the plane of the two fields ϕ_1 e ϕ_2

$$\begin{aligned} \phi'_1 &= \phi_1 \cos \theta + \phi_2 \sin \theta \\ \phi'_2 &= -\phi_1 \sin \theta + \phi_2 \cos \theta \end{aligned} \quad (3.163)$$

In fact the lagrangian is a function of the norm of the following vectors

$$\vec{\phi} = (\phi_1, \phi_2) \quad \partial_\mu \vec{\phi} = (\partial_\mu \phi_1, \partial_\mu \phi_2) \quad (3.164)$$

and the norm is invariant under rotations. For infinitesimal transformations we have

$$\delta\phi_1 = \phi_2\theta, \quad \delta\phi_2 = -\phi_1\theta \quad (3.165)$$

or, in a more compact form

$$\delta\phi_i = \epsilon_{ij}\phi_j\theta \quad (3.166)$$

where ϵ_{ij} is the two-dimensional antisymmetric Ricci tensor, defined by

$$\epsilon_{12} = -\epsilon_{21} = 1 \quad (3.167)$$

From the Noether's theorem, we have a conserved current, associated to this symmetry, given by (see eq. (3.86))

$$J^\mu = \frac{\partial \mathcal{L}}{\partial \phi_{i,\mu}} \Delta \phi_i = \phi_{i,\mu} \epsilon_{ij} \phi_j \theta \quad (3.168)$$

It is convenient to factorize out the angle of the infinitesimal rotation and define a new current

$$j^\mu = \frac{1}{\theta} J^\mu = \phi_{i,\mu} \epsilon_{ij} \phi_j = \phi_{1,\mu} \phi_2 - \phi_{2,\mu} \phi_1 \quad (3.169)$$

The conservation of the current follows from the equality of the masses of the two fields, as one can also verify directly

$$\partial_\mu j^\mu = (\partial^2 \phi_1) \phi_2 - (\partial^2 \phi_2) \phi_1 = -(m_1^2 - m_2^2) \phi_1 \phi_2 \quad (3.170)$$

The conserved charge associated to the current is

$$Q = \int d^3x j^0 = \int d^3x (\dot{\phi}_1 \phi_2 - \dot{\phi}_2 \phi_1) \quad (3.171)$$

and it is the generator of the infinitesimal transformations of the fields

$$[Q, \phi_1] = -i\phi_2, \quad [Q, \phi_2] = i\phi_1 \quad (3.172)$$

with a finite transformation given by

$$U = e^{iQ\theta} \quad (3.173)$$

In fact

$$\begin{aligned} e^{iQ\theta} \phi_1 e^{-iQ\theta} &= \phi_1 + i\theta [Q, \phi_1] + \frac{i^2}{2!} \theta^2 [Q, [Q, \phi_1]] + \dots \\ &= \phi_1 + \theta \phi_2 - \frac{1}{2} \phi_1 \theta^2 + \dots \\ &= \phi_1 \cos \theta + \phi_2 \sin \theta \end{aligned} \quad (3.174)$$

In analogous way one can show the transformation properties of ϕ_2 . The invariance of \mathcal{L} under rotations in the plane (ϕ_1, ϕ_2) is referred to as the invariance under the group $O(2)$. The real basis for the fields used so far is not the most convenient one. In fact, the charge Q mixes the two fields. One can understand better the properties of the charge operator in a basis in which the fields are not mixed. This basis is a complex one and it is given by the combinations

$$\phi = \frac{1}{\sqrt{2}}(\phi_1 + i\phi_2), \quad \phi^\dagger = \frac{1}{\sqrt{2}}(\phi_1 - i\phi_2) \quad (3.175)$$

(the factor $1/\sqrt{2}$ has been inserted for a correct normalization of the fields). It follows

$$[Q, \phi] = \frac{1}{\sqrt{2}}[Q, \phi_1 + i\phi_2] = \frac{1}{\sqrt{2}}(-i\phi_2 - \phi_1) = -\phi \quad (3.176)$$

and analogously

$$[Q, \phi^\dagger] = \phi^\dagger \quad (3.177)$$

Therefore the field ϕ lowers the charge of an eigenstate of Q by one unit, whereas ϕ^\dagger increases the charge by the same amount. In fact, if $Q|q\rangle = q|q\rangle$

$$Q(\phi|q\rangle) = ([Q, \phi] + \phi Q)|q\rangle = (-1 + q)\phi|q\rangle \quad (3.178)$$

and

$$\phi|q\rangle \approx |q-1\rangle \quad (3.179)$$

In analogous way

$$\phi^\dagger|q\rangle \approx |q+1\rangle \quad (3.180)$$

Inverting the relations (3.175) we get

$$\phi_1 = \frac{1}{\sqrt{2}}(\phi + \phi^\dagger), \quad \phi_2 = -\frac{i}{\sqrt{2}}(\phi - \phi^\dagger) \quad (3.181)$$

from which

$$\begin{aligned} \mathcal{L} &= \frac{1}{4} \left[(\partial_\mu \phi + \partial_\mu \phi^\dagger)^2 - (\partial_\mu \phi - \partial_\mu \phi^\dagger)^2 \right] \\ &\quad - \frac{1}{4} m^2 \left[(\phi + \phi^\dagger)^2 - (\phi - \phi^\dagger)^2 \right] \\ &= \partial_\mu \phi^\dagger \partial^\mu \phi - m^2 \phi^\dagger \phi \end{aligned} \quad (3.182)$$

and

$$\begin{aligned} j_\mu &= \phi_{1,\mu} \phi_2 - \phi_{2,\mu} \phi_1 \\ &= -\frac{i}{2} (\partial_\mu \phi + \partial_\mu \phi^\dagger)(\phi - \phi^\dagger) + \frac{i}{2} (\partial_\mu \phi - \partial_\mu \phi^\dagger)(\phi + \phi^\dagger) \\ &= i \left[(\partial_\mu \phi) \phi^\dagger - (\partial_\mu \phi^\dagger) \phi \right] \end{aligned} \quad (3.183)$$

The charge results to be

$$Q = i \int d^3x \phi^\dagger \partial_t^{(-)} \phi \quad (3.184)$$

The commutation relations in the new basis are given by

$$[\phi(\vec{x}, t), \dot{\phi}^\dagger(\vec{y}, t)] = \frac{1}{2} [\phi_1(\vec{x}, t) + i\phi_2(\vec{y}, t), \dot{\phi}_1(\vec{x}, t) - i\dot{\phi}_2(\vec{y}, t)] = i\delta^3(\vec{x} - \vec{y}) \quad (3.185)$$

and

$$\begin{aligned} [\phi(\vec{x}, t), \phi(\vec{y}, t)] &= [\phi^\dagger(\vec{x}, t), \phi^\dagger(\vec{y}, t)] = 0 \\ [\dot{\phi}(\vec{x}, t), \dot{\phi}(\vec{y}, t)] &= [\dot{\phi}^\dagger(\vec{x}, t), \dot{\phi}^\dagger(\vec{y}, t)] = 0 \end{aligned} \quad (3.186)$$

Let us notice that these commutation relations could have also been obtained directly from the lagrangian (3.182), since

$$\Pi_\phi = \frac{\partial \mathcal{L}}{\partial \dot{\phi}} = \dot{\phi}^\dagger, \quad \Pi_{\phi^\dagger} = \frac{\partial \mathcal{L}}{\partial \dot{\phi}^\dagger} = \dot{\phi} \quad (3.187)$$

The original $O(2)$ symmetry becomes now an invariance of the lagrangian (3.182) under a phase transformation of the fields. This follows from (3.182) but it is seen also from the change of variables

$$\begin{aligned} \phi &\rightarrow \frac{1}{\sqrt{2}}(\phi'_1 + i\phi'_2) \\ &= \frac{1}{\sqrt{2}}(\phi_1 \cos \theta + \phi_2 \sin \theta + i(-\phi_1 \sin \theta + \phi_2 \cos \theta)) \\ &= \frac{1}{\sqrt{2}}(\phi_1 e^{-i\theta} + i\phi_2 e^{-i\theta}) = e^{-i\theta} \phi \end{aligned} \quad (3.188)$$

and

$$\phi^\dagger \rightarrow e^{i\theta} \phi^\dagger \quad (3.189)$$

In this basis we speak of invariance under the group $U(1)$ (the group of unitary transformations on the complex vectors of dimensions $d = 1$).

Using the expansion for the real fields

$$\phi_i(x) = \int d^3k [f_{\vec{k}}(x) a_i(\vec{k}) + f_{\vec{k}}^*(x) a_i^\dagger(\vec{k})] \quad (3.190)$$

we get

$$\phi(x) = \int d^3k \left[f_{\vec{k}}(x) \frac{1}{\sqrt{2}}(a_1(\vec{k}) + ia_2(\vec{k})) + f_{\vec{k}}^*(x) \frac{1}{\sqrt{2}}(a_1^\dagger(\vec{k}) + ia_2^\dagger(\vec{k})) \right] \quad (3.191)$$

Introducing the combinations

$$a(\vec{k}) = \frac{1}{\sqrt{2}}(a_1(\vec{k}) + ia_2(\vec{k})), \quad b(\vec{k}) = \frac{1}{\sqrt{2}}(a_1(\vec{k}) - ia_2(\vec{k})) \quad (3.192)$$

it follows

$$\begin{aligned}\phi(x) &= \int d^3k \left[f_{\vec{k}}(x)a(\vec{k}) + f_{\vec{k}}^*(x)b^\dagger(\vec{k}) \right] \\ \phi^\dagger(x) &= \int d^3k \left[f_{\vec{k}}(x)b(\vec{k}) + f_{\vec{k}}^*(x)a^\dagger(\vec{k}) \right]\end{aligned}\quad (3.193)$$

from which we can evaluate the commutation relations for the creation and annihilation operators in the complex basis

$$[a(\vec{k}), a^\dagger(\vec{k}')] = [b(\vec{k}), b^\dagger(\vec{k}')] = \delta^3(\vec{k} - \vec{k}') \quad (3.194)$$

$$[a(\vec{k}), b(\vec{k}')] = [a(\vec{k}), b^\dagger(\vec{k}')] = 0 \quad (3.195)$$

We get also

$$: P_\mu := \int d^3k k_\mu \sum_{i=1}^2 a_i^\dagger(\vec{k}) a_i(\vec{k}) = \int d^3k k_\mu \left[a^\dagger(\vec{k}) a(\vec{k}) + b^\dagger(\vec{k}) b(\vec{k}) \right] \quad (3.196)$$

Therefore the operators $a^\dagger(\vec{k})$ e $b^\dagger(\vec{k})$ both create particles states with momentum k , as the original operators a_i^\dagger . The charge Q is given by

$$\begin{aligned}Q &= i \int d^3x \phi^\dagger \partial_t^{(-)} \phi \\ &= i \int d^3x \int d^3k_1 d^3k_2 \left[f_{\vec{k}_1} b(\vec{k}_1) + f_{\vec{k}_1}^* a^\dagger(\vec{k}_1) \right] \\ &\quad \times \left[(\partial_t^{(-)} f_{\vec{k}_2}) a(\vec{k}_2) + (\partial_t^{(-)} f_{\vec{k}_2}^*) b^\dagger(\vec{k}_2) \right] \\ &= \int d^3k_1 d^3k_2 \delta^3(\vec{k}_1 - \vec{k}_2) \left[a^\dagger(\vec{k}_1) a(\vec{k}_1) - b(\vec{k}_1) b^\dagger(\vec{k}_1) \right]\end{aligned}\quad (3.197)$$

where we have used the orthogonality relations (3.50). For the normal ordered charge operator we get

$$: Q := \int d^3k \left[a^\dagger(\vec{k}) a(\vec{k}) - b^\dagger(\vec{k}) b(\vec{k}) \right] \quad (3.198)$$

showing explicitly that a^\dagger and b^\dagger create particles of charge +1 and -1 respectively. It is important to notice that the current density j_0 is local in the fields, and therefore

$$[j_0(x), j_0(y)] = 0, \quad \forall (x - y)^2 < 0 \quad (3.199)$$

By the same argument of Section 3.5, we construct the operators

$$Q(V_i) = \int_{V_i} d^3x j_0(x) \quad (3.200)$$

which for any non intersecting V_i e V_j commute at equal times. Therefore it is possible to localize a state of definite charge in an arbitrary spatial region. This agrees with the argument we have developed in the case of the number of particles, because the pair creation process does not change the charge of the state.

Finally we notice that the field operator is a linear combination of annihilation, $a(\vec{k})$, and creation, $b^\dagger(\vec{k})$, operators, meaning that a local theory deals in a symmetric way with the annihilation of a particle and the creation of an antiparticle. For instance, to annihilate a charge +1 is equivalent to the creation of a charge -1.

Chapter 4

The Dirac field

4.1 The Dirac equation

In 1928 Dirac tried to solve the problem of a non positive probability density, present in the Klein-Gordon case, formulating a new wave equation. Dirac thought, correctly, that in order to get a positive quantity it was necessary to have a wave equation of the first order in the time derivative (as it happens for the Schrödinger equation). Therefore Dirac looked for a way to reduce the Klein-Gordon equation (of the second order in the time derivative) to a first-order differential equation. The Pauli formulation of the electron spin put Dirac on the right track. In fact, Pauli showed that in order to describe the spin, it was necessary to generalize the Schrödinger wave function (a complex number) to a two components object

$$\psi \rightarrow \psi_\alpha = \begin{bmatrix} \psi_1 \\ \psi_2 \end{bmatrix} \quad (4.1)$$

modifying also the wave equation to a matrix equation

$$i \frac{\partial \psi_\alpha}{\partial t} = \sum_{\beta=1}^2 H_{\alpha\beta} \psi_\beta \quad (4.2)$$

where the hamiltonian H is, in general, a 2×2 matrix. The electron spin is then described by a special set of 2×2 matrices, the Pauli matrices, $\vec{\sigma}$

$$\vec{S} = \frac{1}{2} \vec{\sigma} \quad (4.3)$$

Dirac realized that it was possible to write the squared norm of a spatial vector as

$$|\vec{k}|^2 = (\vec{\sigma} \cdot \vec{k})^2 \quad (4.4)$$

as it follows from

$$[\sigma_i, \sigma_j]_+ = 2\delta_{ij} \quad (4.5)$$

where $[A, B]_+ = AB + BA$.

Following this suggestion Dirac tried to write down a first order differential equation for a many component wave function

$$i\frac{\partial\psi}{\partial t} = -i\vec{\alpha} \cdot \vec{\nabla}\psi + \beta m\psi \equiv H\psi \quad (4.6)$$

where $\vec{\alpha}$ and β are matrices. The requirements that this equation should satisfy are

- the wave function ψ , solution of the Dirac equation, should satisfy also the Klein-Gordon equation in order to get the correct dispersion relation between energy and momentum;
- the equation should admit a conserved current with the fourth component being positive definite;
- the equation should be covariant with respect to Lorentz transformations (see later)

In order to satisfy the first requirement, we iterate the Dirac equation and ask that the resulting second order differential equation coincides with the Klein-Gordon equation

$$\begin{aligned} -\frac{\partial^2\psi}{\partial t^2} &= (-i\vec{\alpha} \cdot \vec{\nabla} + \beta m)^2\psi \\ &= \left(-\alpha^i\alpha^j\frac{\partial^2}{\partial x^i\partial x^j} + \beta^2 m^2 - i(\beta\vec{\alpha} + \vec{\alpha}\beta) \cdot \vec{\nabla} \right)\psi \\ &= \left(-\frac{1}{2}[\alpha^i, \alpha^j]_+ \frac{\partial^2}{\partial x^i\partial x^j} + \beta^2 m^2 - i(\beta\vec{\alpha} + \vec{\alpha}\beta) \cdot \vec{\nabla} \right)\psi \end{aligned} \quad (4.7)$$

We see that it is necessary to require the following matrix relations

$$[\alpha^i, \alpha^j]_+ = 2\delta_{ij}, \quad [\alpha^i, \beta]_+ = 0, \quad \beta^2 = 1 \quad (4.8)$$

In order to get a hamiltonian, H , hermitian, we will require also that $\vec{\alpha}$ and β are hermitian matrices. Since for any choice of i , $(\alpha^i)^2 = 1$, it follows that the eigenvalues of $\vec{\alpha}$ and β must be ± 1 . We can also prove the following relations

$$Tr(\beta) = Tr(\alpha^i) = 0 \quad (4.9)$$

For instance, from $\alpha^i\beta = -\beta\alpha^i$, we get $\alpha^i = -\beta\alpha^i\beta$, and therefore

$$Tr(\alpha^i) = -Tr(\beta\alpha^i\beta) = -Tr(\alpha^i) = 0 \quad (4.10)$$

where we have made use of the cyclic property of the trace. The consequence is that the matrices α^i and β can be realized only in a space of even dimensions. This is perhaps the biggest difficulty that Dirac had to cope with. In fact, the α^i 's enjoy

the same properties of the Pauli matrices, but in a 2×2 matrix space, a further anticommuting matrix β does not exist. It required some time to Dirac before he realized that the previous relations could have been satisfied by 4×4 matrices.

An explicit realization of the Dirac matrices is the following

$$\alpha^i = \begin{bmatrix} 0 & \sigma_i \\ \sigma_i & 0 \end{bmatrix}, \quad \beta = \begin{bmatrix} 1 & 0 \\ 0 & -1 \end{bmatrix} \quad (4.11)$$

as it can be checked

$$[\alpha^i, \alpha^j]_+ = \begin{bmatrix} [\sigma_i, \sigma_j]_+ & 0 \\ 0 & [\sigma_i, \sigma_j]_+ \end{bmatrix} = 2\delta_{ij} \quad (4.12)$$

$$[\beta, \alpha^i]_+ = \begin{bmatrix} 0 & \sigma_i \\ -\sigma_i & 0 \end{bmatrix} + \begin{bmatrix} 0 & -\sigma_i \\ \sigma_i & 0 \end{bmatrix} = 0 \quad (4.13)$$

Let us now show that also the second of our requirements is satisfied. We multiply the Dirac equation by ψ^\dagger at the left, and then we consider the equation for ψ^\dagger

$$-i \frac{\partial \psi^\dagger}{\partial t} = i(\vec{\nabla} \psi^\dagger) \cdot \vec{\alpha} + m \psi^\dagger \beta \quad (4.14)$$

multiplied to the right by ψ . Subtracting the resulting equations we get

$$i \psi^\dagger \frac{\partial \psi}{\partial t} + i \frac{\partial \psi^\dagger}{\partial t} \psi = \psi^\dagger (-i \vec{\alpha} \cdot \vec{\nabla} + \beta m) \psi - (i \vec{\nabla} \psi^\dagger \cdot \vec{\alpha} + \psi^\dagger \beta m) \psi = -i \vec{\nabla} \cdot (\psi^\dagger \vec{\alpha} \psi) \quad (4.15)$$

that is

$$i \frac{\partial}{\partial t} (\psi^\dagger \psi) + i \frac{\partial}{\partial x^j} (\psi^\dagger \alpha^j \psi) = 0 \quad (4.16)$$

We see that the current

$$j^\mu = (\psi^\dagger \psi, \psi^\dagger \alpha^i \psi) \quad (4.17)$$

is a conserved one.

$$\frac{\partial j^\mu}{\partial x^\mu} = 0 \quad (4.18)$$

Furthermore its fourth component $j^0 = \psi^\dagger \psi$ is positive definite. Of course we have still to prove that j^μ is a four-vector, implying that

$$\int d^3x \psi^\dagger \psi \quad (4.19)$$

is invariant with respect to Lorentz transformations.

4.2 Covariance properties of the Dirac equation

To discuss the properties of transformation of the Dirac equation under Lorentz transformations, it turns out convenient to write the equation in a slightly different way. Let us multiply the equation by β

$$i\beta\frac{\partial\psi}{\partial t} = -i\beta\vec{\alpha}\cdot\vec{\nabla}\psi + m\psi \quad (4.20)$$

and let us define the following matrices

$$\gamma^0 = \beta = \begin{bmatrix} 1 & 0 \\ 0 & -1 \end{bmatrix}, \quad \gamma^i = \beta\alpha^i = \begin{bmatrix} 0 & \sigma_i \\ -\sigma_i & 0 \end{bmatrix} \quad (4.21)$$

Then the equation becomes

$$\left(i\gamma^0\frac{\partial}{\partial x^0} + i\gamma^i\frac{\partial}{\partial x^i} - m \right) \psi = 0 \quad (4.22)$$

or, in a compact way

$$(i\hat{\partial} - m)\psi = 0 \quad (4.23)$$

where

$$\hat{\partial} = \gamma^\mu\frac{\partial}{\partial x^\mu} = \gamma^\mu\partial_\mu \quad (4.24)$$

The matrices γ^μ satisfy the following anticommutation relations

$$[\gamma^i, \gamma^j]_+ = \beta\alpha^i\beta\alpha^j + \beta\alpha^j\beta\alpha^i = -[\alpha^i, \alpha^j]_+ = -2\delta_{ij} \quad (4.25)$$

$$[\gamma^0, \gamma^i]_+ = [\beta, \beta\alpha^i]_+ = \alpha^i + \beta\alpha^i\beta = 0 \quad (4.26)$$

or

$$[\gamma^\mu, \gamma^\nu]_+ = 2g^{\mu\nu} \quad (4.27)$$

Notice that

$$(\gamma^i)^\dagger = (\beta\alpha^i)^\dagger = \alpha^i\beta = -\gamma^i \quad (4.28)$$

and

$$(\gamma^i)^2 = -1 \quad (4.29)$$

The covariance of the Dirac equation means that the following two conditions are satisfied

- given the Dirac wave function $\psi(x)$ in the Lorentz frame, S , an observer in a different frame, S' should be able to evaluate, in terms of $\psi(x)$, the wave function $\psi'(x')$ describing the same physical state as $\psi(x)$ in S ;

- according to the relativity principle, $\psi'(x')$ must be a solution of an equation that in S' has the same form as the Dirac equation in S . That is to say

$$\left(i\tilde{\gamma}^\mu \frac{\partial}{\partial x'^\mu} - m\right) \psi'(x') = 0 \quad (4.30)$$

The matrices $\tilde{\gamma}^\mu$ should satisfy the same algebra as the matrices γ^μ , because in both cases the wave functions should satisfy the Klein-Gordon equation (which is invariant in form). Therefore, neglecting a possible unitary transformations, the two sets of matrices can be identified. As a consequence, the Dirac equation in S' will be

$$\left(i\gamma^\mu \frac{\partial}{\partial x'^\mu} - m\right) \psi'(x') = 0 \quad (4.31)$$

Since both the Dirac equation and the Lorentz transformations are linear, we will require that the wave functions in two different Lorentz frames are linearly correlated

$$\psi'(x') = \psi'(\Lambda x) = S(\Lambda)\psi(x) \quad (4.32)$$

where $S(\Lambda)$ is a 4×4 matrix operating on the complex vector $\psi(x)$ and Λ is the Lorentz transformation. On physical ground, the matrix $S(\Lambda)$ should be invertible

$$\psi(x) = S^{-1}(\Lambda)\psi'(x') \quad (4.33)$$

but using the relativity principle, since one goes from the frame S' to the frame S through the transformation Λ^{-1} , we must have

$$\psi(x) = S(\Lambda^{-1})\psi'(x') \quad (4.34)$$

from which

$$S^{-1}(\Lambda) = S(\Lambda^{-1}) \quad (4.35)$$

Considering the Dirac equation in the frame S

$$\left(i\gamma^\mu \frac{\partial}{\partial x^\mu} - m\right) \psi(x) = 0 \quad (4.36)$$

we can write

$$\left(i\gamma^\mu \frac{\partial}{\partial x^\mu} - m\right) S^{-1}(\Lambda)\psi'(x') = 0 \quad (4.37)$$

Multiplying to the left by $S(\Lambda)$ and using

$$\frac{\partial}{\partial x^\mu} = \frac{\partial x'_\nu}{\partial x^\mu} \frac{\partial}{\partial x'_\nu} = \Lambda_{\nu\mu} \frac{\partial}{\partial x'_\nu}, \quad x'_\nu = \Lambda_{\nu\mu} x^\mu \quad (4.38)$$

it follows

$$\left(iS(\Lambda)\gamma^\mu S^{-1}(\Lambda)\Lambda_{\nu\mu} \frac{\partial}{\partial x'_\nu} - m\right) \psi'(x') = 0 \quad (4.39)$$

Comparing with eq. (4.30), we get

$$S(\Lambda)\gamma^\mu S^{-1}(\Lambda)\Lambda_{\nu\mu} = \gamma_\nu \quad (4.40)$$

or

$$S^{-1}(\Lambda)\gamma_\nu S(\Lambda) = \Lambda_{\nu\mu}\gamma^\mu \quad (4.41)$$

For an infinitesimal transformation we obtain

$$\Lambda_{\mu\nu} = g_{\mu\nu} + \epsilon_{\mu\nu} \quad (4.42)$$

with $\epsilon_{\mu\nu} = -\epsilon_{\nu\mu}$ (see eq. (3.93)). By expanding $S(\Lambda)$ to the first order in $\epsilon_{\mu\nu}$, we get

$$S(\Lambda) = 1 - \frac{i}{4}\sigma_{\mu\nu}\epsilon^{\mu\nu} \quad (4.43)$$

and using (4.41), we find the following condition on $\sigma_{\mu\nu}$

$$\left(1 + \frac{i}{4}\sigma_{\rho\lambda}\epsilon^{\rho\lambda}\right)\gamma_\nu \left(1 - \frac{i}{4}\sigma_{\alpha\beta}\epsilon^{\alpha\beta}\right) = (g_{\mu\nu} + \epsilon_{\nu\mu}\gamma^\mu) \quad (4.44)$$

from which

$$\frac{i}{4}\epsilon^{\rho\lambda}[\sigma_{\rho\lambda}, \gamma_\nu] = \epsilon_{\nu\mu}\gamma^\mu = \frac{1}{2}\epsilon^{\rho\lambda}(g_{\rho\nu}\gamma_\lambda - g_{\lambda\nu}\gamma_\rho) \quad (4.45)$$

and finally

$$[\sigma_{\rho\lambda}, \gamma_\nu] = -2i(g_{\rho\nu}\gamma_\lambda - g_{\lambda\nu}\gamma_\rho) \quad (4.46)$$

It is not difficult to show that the solution of this equation is given by

$$\sigma_{\rho\lambda} = \frac{i}{2}[\gamma_\rho, \gamma_\lambda] \quad (4.47)$$

In fact

$$\begin{aligned} [\sigma_{\rho\lambda}, \gamma_\nu] &= \frac{i}{2}[\gamma_\rho\gamma_\lambda - \gamma_\lambda\gamma_\rho, \gamma_\nu] = \frac{i}{2}[\gamma_\rho\gamma_\lambda\gamma_\nu - \gamma_\nu\gamma_\rho\gamma_\lambda - \gamma_\lambda\gamma_\rho\gamma_\nu + \gamma_\nu\gamma_\lambda\gamma_\rho] \\ &= \frac{i}{2}[(2g_{\rho\lambda} - \gamma_\lambda\gamma_\rho)\gamma_\nu - \gamma_\nu(2g_{\rho\lambda} - \gamma_\lambda\gamma_\rho) - \gamma_\lambda\gamma_\rho\gamma_\nu + \gamma_\nu\gamma_\lambda\gamma_\rho] \\ &= -i[\gamma_\lambda\gamma_\rho\gamma_\nu - \gamma_\nu\gamma_\lambda\gamma_\rho] = -i[\gamma_\lambda(2g_{\rho\nu} - \gamma_\nu\gamma_\rho) - (2g_{\nu\lambda} - \gamma_\lambda\gamma_\nu)\gamma_\rho] \\ &= -2i[g_{\rho\nu}\gamma_\lambda - g_{\nu\lambda}\gamma_\rho] \end{aligned} \quad (4.48)$$

A finite Lorentz transformation is obtained by exponentiation

$$S(\Lambda) = e^{-\frac{i}{4}\sigma_{\mu\nu}\epsilon^{\mu\nu}} \quad (4.49)$$

with

$$\sigma_{\mu\nu} = \frac{i}{2}[\gamma_\mu, \gamma_\nu] \quad (4.50)$$

We can now verify that the current j^μ , defined in eq. (4.17) transforms as a four vector. To this end we introduce the following notation

$$\bar{\psi}(x) = \psi^\dagger(x)\beta = \psi^\dagger(x)\gamma_0 \quad (4.51)$$

It follows

$$j^0 = \psi^\dagger\psi = \bar{\psi}\gamma^0\psi, \quad j^i = \psi^\dagger\alpha^i\psi = \bar{\psi}\beta\alpha^i\psi = \bar{\psi}\gamma^i\psi \quad (4.52)$$

or

$$j^\mu = \bar{\psi}\gamma^\mu\psi \quad (4.53)$$

The transformation properties of $\bar{\psi}$ under Lorentz transformations are particularly simple. By noticing that

$$\gamma^0\gamma^{\mu\dagger}\gamma^0 = \gamma^\mu \quad (4.54)$$

and

$$\sigma_{\mu\nu}^\dagger = -\frac{i}{2}[\gamma_\mu, \gamma_\nu]^\dagger = \frac{i}{2}[\gamma_\mu^\dagger, \gamma_\nu^\dagger] \quad (4.55)$$

it follows

$$\gamma_0\sigma_{\mu\nu}^\dagger\gamma_0 = \sigma_{\mu\nu} \quad (4.56)$$

and therefore

$$\gamma_0 S^\dagger(\Lambda)\gamma_0 = S^{-1}(\Lambda) \quad (4.57)$$

from which

$$\bar{\psi}'(x') = \bar{\psi}(x)S^{-1}(\Lambda) \quad (4.58)$$

We get

$$j'^\mu(x') = \bar{\psi}'(x')\gamma^\mu\psi'(x') = \bar{\psi}(x)S^{-1}(\Lambda)\gamma^\mu S(\Lambda)\psi(x) = \Lambda_\nu^\mu\bar{\psi}(x)\gamma^\nu\psi(x) = \Lambda_\nu^\mu j^\nu(x) \quad (4.59)$$

We see that j^μ has the desired transformation properties. The representation for the Lorentz generators, in the same basis used previously for the γ_μ matrices, is

$$\sigma_{0i} = \frac{i}{2}[\gamma_0, \gamma_i] = \frac{i}{2}(\beta^2\alpha_i - \beta\alpha_i\beta) = -i\alpha^i = -i \begin{bmatrix} 0 & \sigma_i \\ \sigma_i & 0 \end{bmatrix} \quad (4.60)$$

$$\begin{aligned} \sigma_{ij} = \frac{i}{2}[\gamma_i, \gamma_j] &= \frac{i}{2}(\beta\alpha_i\beta\alpha_j - \beta\alpha_j\beta\alpha_i) = -\frac{i}{2}[\alpha_i, \alpha_j] \\ &= -\frac{i}{2} \begin{bmatrix} [\sigma_i, \sigma_j] & 0 \\ 0 & [\sigma_i, \sigma_j] \end{bmatrix} \\ &= \epsilon_{ijk} \begin{bmatrix} \sigma_k & 0 \\ 0 & \sigma_k \end{bmatrix} \end{aligned} \quad (4.61)$$

We see that the generators of the spatial rotations are nothing but the Pauli matrices, as one should expect for spin 1/2 particles.

The behaviour of the Dirac wave function under parity $\vec{x} \rightarrow -\vec{x}$ can be obtained in analogous way. In this case

$$\Lambda_{P\mu}^\nu = \begin{bmatrix} 1 & & & \\ & -1 & & \\ & & -1 & \\ & & & -1 \end{bmatrix} \quad (4.62)$$

and therefore

$$S^{-1}(\Lambda_P)\gamma^\mu S(\Lambda_P) = \gamma_\mu \quad (4.63)$$

This relation is satisfied by the choice

$$S(\Lambda_P) = \eta_P \gamma_0 \quad (4.64)$$

where η_P is a non observable arbitrary phase. Then

$$\psi(x) \rightarrow \psi'(x') = \eta_P \gamma_0 \psi(x), \quad x'^\mu = (x^0, -\vec{x}) \quad (4.65)$$

We are now in the position to classify the bilinear expressions in the Dirac wave function under Lorentz transformations. Let us consider expressions of the type $\bar{\psi}A\psi$, where A is an arbitrary 4×4 matrix. As a basis for the 4×4 matrices we can take the following set of 16 linearly independent matrices

$$\begin{aligned} \Gamma^S &= 1 \\ \Gamma_\mu^V &= \gamma_\mu \\ \Gamma_\mu^A &= \gamma_5 \gamma_\mu \\ \Gamma_{\mu\nu}^T &= \sigma_{\mu\nu} \\ \Gamma^P &= \gamma_5 \end{aligned} \quad (4.66)$$

where the matrix γ_5 is defined as

$$\gamma_5 = \gamma^5 = i\gamma^0\gamma^1\gamma^2\gamma^3 \quad (4.67)$$

This matrix has the following properties

$$\gamma_5^\dagger = i\gamma^3\gamma^2\gamma^1\gamma^0 = i\gamma^0\gamma^1\gamma^2\gamma^3 = \gamma_5 \quad (4.68)$$

$$\gamma_5^2 = 1, \quad [\gamma_5, \gamma_\mu]_+ = 0 \quad (4.69)$$

$$\gamma_5 = \begin{bmatrix} 0 & 1 \\ 1 & 0 \end{bmatrix} \quad (4.70)$$

One can easily verify that the bilinear expressions have the following behaviour under Lorentz transformations

$$\begin{aligned} \bar{\psi}\psi &\approx \text{scalar} \\ \bar{\psi}\gamma_\mu\psi &\approx \text{four - vector} \\ \bar{\psi}\gamma_5\gamma_\mu\psi &\approx \text{axial four - vector} \\ \bar{\psi}\sigma_{\mu\nu}\psi &\approx \text{2}^{\text{nd}} \text{ rank antisymmetric tensor} \\ \bar{\psi}\gamma_5\psi &\approx \text{pseudoscalar} \end{aligned} \quad (4.71)$$

As an example, let us verify the last of these transformation properties

$$\bar{\psi}(x)\gamma_5\psi(x) \rightarrow \bar{\psi}'(x')\gamma_5\psi'(x') = \eta_P^*\eta_P\bar{\psi}(x)\gamma_0\gamma_5\gamma_0\psi(x) = -\bar{\psi}(x)\gamma_5\psi(x) \quad (4.72)$$

4.3 Free particle solutions of the Dirac equation

In this Section we will study the wave plane solutions of the Dirac equation. In the rest frame of the particle we look for solutions of the type

$$\psi(t) = ue^{-imt} \quad (4.73)$$

where u is a four components complex vector (usually called a spinor). This solution has positive energy. Substituting inside the Dirac equation we get

$$(i\hat{\partial} - m)\psi(t) = (m\gamma_0 - m)ue^{-imt} = 0 \quad (4.74)$$

that is

$$(\gamma_0 - 1)u = 0 \quad (4.75)$$

Since γ_0 has eigenvalues ± 1 , we see that the Dirac equation admits also solutions of the type e^{imt} , corresponding to a negative energy state. More generally we can look for solutions of the form

$$\begin{aligned} \psi^{(+)}(x) &= e^{-ikx}u(k), & \text{positive energy} \\ \psi^{(-)}(x) &= e^{ikx}v(k), & \text{negative energy} \end{aligned} \quad (4.76)$$

Inserting in the Dirac equation

$$\begin{aligned} (\hat{k} - m)u(k) &= 0 \\ (\hat{k} + m)v(k) &= 0 \end{aligned} \quad (4.77)$$

In the rest frame we get

$$\begin{aligned} (\gamma_0 - 1)u(m, \vec{0}) &= 0 \\ (\gamma_0 + 1)v(m, \vec{0}) &= 0 \end{aligned} \quad (4.78)$$

There are two independent spinors of type u and two of type v satisfying these equations. In the basis where γ_0 is a diagonal matrix we can choose the following solutions

$$\begin{aligned} u^{(1)}(m, \vec{0}) &= \begin{bmatrix} 1 \\ 0 \\ 0 \\ 0 \end{bmatrix}, & u^{(2)}(m, \vec{0}) &= \begin{bmatrix} 0 \\ 1 \\ 0 \\ 0 \end{bmatrix} \\ v^{(1)}(m, \vec{0}) &= \begin{bmatrix} 0 \\ 0 \\ 1 \\ 0 \end{bmatrix}, & v^{(2)}(m, \vec{0}) &= \begin{bmatrix} 0 \\ 0 \\ 0 \\ 1 \end{bmatrix} \end{aligned} \quad (4.79)$$

In a general Lorentz frame the solutions could be obtained by boosting the solutions in the rest frame. Or, we can notice that the following expression

$$(\hat{k} - m)(\hat{k} + m) = k^2 - m^2 \quad (4.80)$$

vanishes for $k^2 = m^2$. Therefore we can solve our problem (except for a normalization constant), by putting

$$\begin{aligned} u^{(\alpha)}(k) &= c_\alpha (\hat{k} + m) u^{(\alpha)}(m, \vec{0}) \\ v^{(\alpha)}(k) &= d_\alpha (-\hat{k} + m) v^{(\alpha)}(m, \vec{0}) \end{aligned} \quad (4.81)$$

with $k^2 = m^2$. In order to determine the normalization constants c_α and d_α we make use of the orthogonality conditions satisfied by the rest frame solutions (see eq. (4.79))

$$\begin{aligned} \bar{u}^{(\alpha)}(m, \vec{0}) u^{(\beta)}(m, \vec{0}) &= \delta_{\alpha\beta} \\ \bar{v}^{(\alpha)}(m, \vec{0}) v^{(\beta)}(m, \vec{0}) &= -\delta_{\alpha\beta} \\ \bar{u}^{(\alpha)}(m, \vec{0}) v^{(\beta)}(m, \vec{0}) &= 0 \end{aligned} \quad (4.82)$$

Since these relations involve Lorentz scalars, $\bar{\psi}\psi$, we can ask that they are satisfied also for $u^{(\alpha)}(k)$ e $v^{(\alpha)}(k)$. Let us start with the u spinors:

$$\begin{aligned} \bar{u}^{(\alpha)}(k) u^{(\beta)}(k) &= |c_\alpha|^2 \bar{u}^{(\alpha)}(m, \vec{0}) (\hat{k} + m)^2 u^{(\beta)}(m, \vec{0}) \\ &= |c_\alpha|^2 \bar{u}^{(\alpha)}(m, \vec{0}) (2m^2 + 2m\hat{k}) u^{(\beta)}(m, \vec{0}) \end{aligned} \quad (4.83)$$

By taking into account that $u^{(\alpha)}(m, \vec{0})$ and $u^{\dagger(\alpha)}(m, \vec{0})$ are eigenstates of γ_0 with eigenvalue +1, we get

$$\begin{aligned} \bar{u}^{(\alpha)}(m, \vec{0}) \gamma^\mu u^{(\beta)}(m, \vec{0}) &= u^{\dagger(\alpha)}(m, \vec{0}) \gamma^\mu u^{(\beta)}(m, \vec{0}) \\ &= u^{\dagger(\alpha)}(m, \vec{0}) \gamma_0 \gamma^\mu \gamma_0 u^{(\beta)}(m, \vec{0}) = u^{\dagger(\alpha)}(m, \vec{0}) \gamma_\mu u^{(\beta)}(m, \vec{0}) \end{aligned} \quad (4.84)$$

from which

$$\begin{aligned} \bar{u}^{(\alpha)}(m, \vec{0}) \gamma^\mu u^{(\beta)}(m, \vec{0}) &= u^{\dagger(\alpha)}(m, \vec{0}) \gamma^\mu u^{(\beta)}(m, \vec{0}) \\ &= g^{\mu 0} u^{\dagger(\alpha)}(m, \vec{0}) \gamma_0 u^{(\beta)}(m, \vec{0}) = g^{\mu 0} \delta_{\alpha\beta} \end{aligned} \quad (4.85)$$

that is

$$\bar{u}^{(\alpha)}(k) u^{(\beta)}(k) = |c_\alpha|^2 (2m^2 + 2mE) \delta_{\alpha\beta} \quad (4.86)$$

Than we choose

$$c_\alpha = \frac{1}{\sqrt{2m(m+E)}}, \quad E = \sqrt{|\vec{k}|^2 + m^2} \quad (4.87)$$

In analogous way we have

$$\begin{aligned} \bar{v}^{(\alpha)}(k) v^{(\beta)}(k) &= |d_\alpha|^2 \bar{v}^{(\alpha)}(m, \vec{0}) (-\hat{k} + m)^2 v^{(\beta)}(m, \vec{0}) \\ &= |d_\alpha|^2 \bar{v}^{(\alpha)}(m, \vec{0}) (2m^2 - 2m\hat{k}) v^{(\beta)}(m, \vec{0}) \end{aligned} \quad (4.88)$$

and using the fact that $v^{(\alpha)}(m, \vec{0})$ and $v^{\dagger(\alpha)}(m, \vec{0})$ are eigenstates of γ_0 with eigenvalue -1 , we get

$$\begin{aligned}\bar{v}^{(\alpha)}(m, \vec{0})\gamma^\mu v^{(\beta)}(m, \vec{0}) &= -v^{\dagger(\alpha)}(m, \vec{0})\gamma^\mu v^{(\beta)}(m, \vec{0}) \\ &= -v^{\dagger(\alpha)}(m, \vec{0})\gamma_0\gamma^\mu\gamma_0 v^{(\beta)}(m, \vec{0}) = -v^{\dagger(\alpha)}(m, \vec{0})\gamma_\mu v^{(\beta)}(m, \vec{0})\end{aligned}\quad (4.89)$$

that is

$$\begin{aligned}\bar{v}^{(\alpha)}(m, \vec{0})\gamma^\mu v^{(\beta)}(m, \vec{0}) &= -v^{\dagger(\alpha)}(m, \vec{0})\gamma^\mu v^{(\beta)}(m, \vec{0}) \\ &= -g^{\mu 0}v^{\dagger(\alpha)}(m, \vec{0})\gamma^0 v^{(\beta)}(m, \vec{0}) = g^{\mu 0}\delta_{\alpha\beta}\end{aligned}\quad (4.90)$$

Recalling that $\bar{v}^{(\alpha)}(m, \vec{0})v^{(\beta)}(m, \vec{0}) = -\delta_{\alpha\beta}$, we obtain

$$\bar{v}^{(\alpha)}(k)v^{(\beta)}(k) = -|d_\alpha|^2(2m^2 + 2mE)\delta_{\alpha\beta}\quad (4.91)$$

and finally

$$d_\alpha = c_\alpha = \frac{1}{\sqrt{2m(m+E)}}\quad (4.92)$$

The normalized solutions we have obtained are

$$u^{(\alpha)}(k) = \frac{\hat{k} + m}{\sqrt{2m(m+E)}}u^{(\alpha)}(m, \vec{0}), \quad v^{(\alpha)}(k) = \frac{-\hat{k} + m}{\sqrt{2m(m+E)}}v^{(\alpha)}(m, \vec{0})\quad (4.93)$$

Notice that positive and negative energy spinors are orthogonal. In the following it will be useful to express our solutions in terms of two component spinors, $\phi^{(\alpha)}(m, \vec{0})$ and $\chi^{(\alpha)}(m, \vec{0})$

$$u^{(\alpha)}(m, \vec{0}) = \begin{bmatrix} \phi^{(\alpha)}(m, \vec{0}) \\ 0 \end{bmatrix}, \quad v^{(\alpha)}(m, \vec{0}) = \begin{bmatrix} 0 \\ \chi^{(\alpha)}(m, \vec{0}) \end{bmatrix}\quad (4.94)$$

From the explicit representation of the γ^μ matrices we get

$$\hat{k} = \begin{bmatrix} E & 0 \\ 0 & -E \end{bmatrix} - \begin{bmatrix} 0 & \vec{k} \cdot \vec{\sigma} \\ -\vec{k} \cdot \vec{\sigma} & 0 \end{bmatrix} = \begin{bmatrix} E & -\vec{k} \cdot \vec{\sigma} \\ \vec{k} \cdot \vec{\sigma} & -E \end{bmatrix}\quad (4.95)$$

from which

$$u^{(\alpha)}(k) = \begin{bmatrix} \sqrt{\frac{m+E}{2m}}\phi^{(\alpha)}(m, \vec{0}) \\ \frac{\vec{k} \cdot \vec{\sigma}}{\sqrt{2m(m+E)}}\phi^{(\alpha)}(m, \vec{0}) \end{bmatrix}, \quad v^{(\alpha)}(k) = \begin{bmatrix} \frac{\vec{k} \cdot \vec{\sigma}}{\sqrt{2m(m+E)}}\chi^{(\alpha)}(m, \vec{0}) \\ \sqrt{\frac{m+E}{2m}}\chi^{(\alpha)}(m, \vec{0}) \end{bmatrix}\quad (4.96)$$

In the following we will need the explicit expression for the projectors of the positive and negative energy solutions. To this end, let us observe that

$$\sum_{\alpha=1}^2 u^{(\alpha)}(m, \vec{0}) \bar{u}^{(\alpha)}(m, \vec{0}) = \begin{bmatrix} 1 \\ 0 \\ 0 \\ 0 \end{bmatrix} [1 \ 0 \ 0 \ 0] + \begin{bmatrix} 0 \\ 1 \\ 0 \\ 0 \end{bmatrix} [0 \ 1 \ 0 \ 0] = \frac{1 + \gamma_0}{2} \quad (4.97)$$

and analogously

$$\sum_{\alpha=1}^2 v^{(\alpha)}(m, \vec{0}) \bar{v}^{(\alpha)}(m, \vec{0}) = -\frac{1 - \gamma_0}{2} \quad (4.98)$$

Using $\gamma_0 \gamma_\mu = 2g_{\mu 0} - \gamma_\mu \gamma_0$ e $k^2 = m^2$, we get

$$\begin{aligned} (\hat{k} + m)\gamma_0(\hat{k} + m) &= (\hat{k} + m)(2E - \hat{k}\gamma_0 + m\gamma_0) \\ &= 2E(\hat{k} + m) - (\hat{k} + m)(-\hat{k} + m)\gamma_0 \\ &= 2E(\hat{k} + m) \end{aligned} \quad (4.99)$$

Therefore the positive energy projector is given by

$$\begin{aligned} \Lambda_+(k) &= \sum_{\alpha=1}^2 u^{(\alpha)}(k) \bar{u}^{(\alpha)}(k) = \frac{\hat{k} + m}{\sqrt{2m(m + E)}} \frac{1 + \gamma_0}{2} \frac{\hat{k} + m}{\sqrt{2m(m + E)}} \\ &= \frac{1}{2m(m + E)} \frac{(\hat{k} + m)^2 + 2E(\hat{k} + m)}{2} = \frac{k^2 + m^2 + 2m\hat{k} + 2E(\hat{k} + m)}{4m(m + E)} \\ &= \frac{(2E + 2m)(\hat{k} + m)}{4m(m + E)} = \frac{\hat{k} + m}{2m} \end{aligned} \quad (4.100)$$

Analogously

$$\begin{aligned} \Lambda_-(k) &= -\sum_{\alpha=1}^2 v^{(\alpha)}(k) \bar{v}^{(\alpha)}(k) = -\frac{\hat{k} - m}{\sqrt{2m(m + E)}} \frac{1 - \gamma_0}{2} \frac{\hat{k} - m}{\sqrt{2m(m + E)}} \\ &= \frac{1}{2m(m + E)} \frac{(\hat{k} - m)^2 - 2E(\hat{k} - m)}{2} = \frac{k^2 + m^2 - 2m\hat{k} - 2E(\hat{k} - m)}{4m(m + E)} \\ &= \frac{(2E + 2m)(-\hat{k} + m)}{4m(m + E)} = \frac{-\hat{k} + m}{2m} \end{aligned} \quad (4.101)$$

It is easy to verify that the matrices $\Lambda_{\pm}(k)$ verify all the properties of a complete set of projection operators

$$\Lambda_{\pm}^2 = \Lambda_{\pm}, \quad \Lambda_+ \Lambda_- = 0, \quad \Lambda_+ + \Lambda_- = 1 \quad (4.102)$$

In this normalization the density $\psi^\dagger \psi$ has the correct Lorentz transformation properties

$$\psi_{(\alpha)}^{(+)\dagger}(x) \psi_{(\beta)}^{(+)}(x) = \bar{u}^{(\alpha)}(k) \gamma_0 u^{(\beta)}(k)$$

$$\begin{aligned}
&= \frac{1}{2m(m+E)} \bar{u}^{(\alpha)}(m, \vec{0}) (\hat{k} + m) \gamma_0 (\hat{k} + m) u^{(\beta)}(m, \vec{0}) \\
&= \frac{1}{2m(m+E)} 2E \bar{u}^{(\alpha)}(m, \vec{0}) (\hat{k} + m) u^{(\beta)}(m, \vec{0}) \\
&= \frac{2E(m+E)}{2m(m+E)} \delta_{\alpha\beta} = \frac{E}{m} \delta_{\alpha\beta} \tag{4.103}
\end{aligned}$$

Therefore the density for positive energy solutions transforms as the fourth component of a four vector. The same is true for the negative energy solutions

$$\begin{aligned}
\psi_{(\alpha)}^{(-)\dagger}(x) \psi_{(\beta)}^{(-)} &= \bar{v}^{(\alpha)}(k) \gamma_0 v^{(\beta)}(k) \\
&= \frac{1}{2m(m+E)} \bar{v}^{(\alpha)}(m, \vec{0}) (\hat{k} - m) \gamma_0 (\hat{k} - m) v^{(\beta)}(m, \vec{0}) \\
&= \frac{1}{2m(m+E)} 2E \bar{v}^{(\alpha)}(m, \vec{0}) (\hat{k} - m) v^{(\beta)}(m, \vec{0}) \\
&= \frac{2E(m+E)}{2m(m+E)} \delta_{\alpha\beta} = \frac{E}{m} \delta_{\alpha\beta} \tag{4.104}
\end{aligned}$$

We find also

$$u^{\dagger(\alpha)}(k) v^{(\beta)}(\tilde{k}) = 0, \quad k^\mu = (E, \vec{k}), \quad \tilde{k}^\mu = (E, -\vec{k}) \tag{4.105}$$

In fact

$$\begin{aligned}
u^{\dagger(\alpha)}(k) v^{(\beta)}(\tilde{k}) &= \bar{u}^{(\alpha)}(m, \vec{0}) \frac{(\hat{k} + m) \gamma_0 (-\hat{k} + m)}{2m(m+E)} v^{(\beta)}(m, \vec{0}) \\
&= \bar{u}^{(\alpha)}(m, \vec{0}) \frac{(\hat{k} + m) (-\hat{k} + m) \gamma_0}{2m(m+E)} v^{(\beta)}(m, \vec{0}) = 0 \tag{4.106}
\end{aligned}$$

It follows that solutions with opposite energy and same three momentum are orthogonal

$$\begin{aligned}
\psi^{(+)} &= e^{-i(Ex^0 - \vec{k} \cdot \vec{x})} u(k), \quad k^\mu = (E, \vec{k}) \\
\psi^{(-)} &= e^{+i(Ex^0 + \vec{k} \cdot \vec{x})} v(\tilde{k}), \quad \tilde{k}^\mu = (E, -\vec{k}) \tag{4.107}
\end{aligned}$$

The positive and negative energy solutions are doubly degenerate. It is possible to remove the degeneration through the construction of projectors for states with definite polarization. Let us consider again the solutions in the frame system. The generator of the rotations along the z -axis is given by

$$\sigma_{12} = \begin{bmatrix} \sigma_3 & 0 \\ 0 & \sigma_3 \end{bmatrix} \tag{4.108}$$

Clearly $u^{(1)}(m, \vec{0})$ and $v^{(1)}(m, \vec{0})$ are eigenstates of this operator (and therefore of the third component of the spin operator) with eigenvalues $+1$, whereas $u^{(2)}(m, \vec{0})$

and $v^{(2)}(m, \vec{0})$ belong to the eigenvalue -1 . The projector for the eigenstates with eigenvalues $+1$ is given by

$$\frac{1 + \sigma_{12} n_R^3}{2} \equiv \frac{1 + \sigma_{12}}{2} \quad (4.109)$$

where $n_R^\mu = (0, 0, 0, 1)$ is a unit space-like four-vector. Also we have

$$\sigma_{12} = \frac{i}{2}[\gamma_1, \gamma_2] = i\gamma^1\gamma^2 = -\gamma^0\gamma_5\gamma^3 = \gamma_5\gamma_3\gamma_0 \quad (4.110)$$

and

$$\sigma_{12} n_R^3 = \gamma_5 \hat{n}_R \gamma_0 \quad (4.111)$$

The presence of γ_0 forbids a simple extension of this expression to a generic Lorentz frame. We can avoid this, by changing the definition of the projection in the rest frame system. Let us put

$$\Sigma(\pm n_R) = \frac{1 \pm \sigma_{12} n_R^3 \gamma_0}{2} = \frac{1}{2} \begin{bmatrix} 1 \pm \sigma_3 & 0 \\ 0 & 1 \mp \sigma_3 \end{bmatrix} \quad (4.112)$$

In this case $\Sigma(n_R)$ and $\Sigma(-n_R)$ project out $u^{(1)}(m, \vec{0})$, $v^{(2)}(m, \vec{0})$ and $u^{(2)}(m, \vec{0})$, $v^{(1)}(m, \vec{0})$, respectively. That is, $\Sigma(\pm n_R)$ projects out the positive energy solutions with spin $\pm 1/2$ and the negative energy solutions with spin $\mp 1/2$. Then, we have

$$\Sigma(\pm n_R) = \frac{1 \pm \gamma_5 \hat{n}_R}{2} \quad (4.113)$$

In the rest frame we have $n_R^2 = -1$, $n_R k = 0$. We can go to a generic frame preserving these conditions

$$\Sigma(\pm n) = \frac{1 \pm \gamma_5 \hat{n}}{2}, \quad n^2 = -1, \quad nk = 0 \quad (4.114)$$

The projector $\Sigma(\pm n)$ projects out energy positive states that in the frame system have a polarization given by $\vec{S} \cdot \vec{n} = \pm 1/2$, and the negative energy states with polarization $\vec{S} \cdot \vec{n} = \mp 1/2$.

In the following we will use the following notation

$$\begin{aligned} u(k_R, n_R) &= u^{(1)}(m, \vec{0}) \\ u(k_R, -n_R) &= u^{(2)}(m, \vec{0}) \\ v(k_R, -n_R) &= v^{(1)}(m, \vec{0}) \\ v(k_R, n_R) &= v^{(2)}(m, \vec{0}) \end{aligned} \quad (4.115)$$

These spinors satisfy the following relations

$$\Sigma(\pm n_R) u(k_R, \pm n_R) = u(k_R, \pm n_R), \quad \Sigma(\pm n_R) v(k_R, \pm n_R) = v(k_R, \pm n_R) \quad (4.116)$$

and

$$\Sigma(\pm n_R) u(k_R, \mp n_R) = \Sigma(\pm n_R) v(k_R, \mp n_R) = 0 \quad (4.117)$$

All these relations generalize immediately to an arbitrary reference frame (always requiring $n^2 = -1$ e $nk = 0$)

$$\Sigma(\pm n)u(k, \pm n) = u(k, \pm n), \quad \Sigma(\pm n)v(k, \pm n) = v(k, \pm n) \quad (4.118)$$

$$\Sigma(\pm n)u(k, \mp n) = \Sigma(\pm n)v(k, \mp n) = 0 \quad (4.119)$$

The properties of the spin projectors are

$$\Sigma(n) + \Sigma(-n) = 1, \quad \Sigma(\pm n)^2 = \Sigma(\pm n), \quad \Sigma(n)\Sigma(-n) = 0 \quad (4.120)$$

Let us just verify the second equation

$$\left(\frac{1 + \gamma_5 \hat{n}}{2}\right)^2 = \frac{1 + (\gamma_5 \hat{n})^2 + 2\gamma_5 \hat{n}}{4} = \frac{2 + 2\gamma_5 \hat{n}}{4} = \Sigma(n) \quad (4.121)$$

where we have made use of $n^2 = -1$. In analogous way

$$\frac{1 + \gamma_5 \hat{n}}{2} \frac{1 - \gamma_5 \hat{n}}{2} = \frac{1 - (\gamma_5 \hat{n})^2}{4} = 0 \quad (4.122)$$

4.4 Wave packets and negative energy solutions

As we have shown the Dirac equation leads to a positive probability density. This solves the problem one had with the Klein-Gordon equation. On the other hand the Dirac equation does not solve the problem of the negative energy solutions (and it should not, as we have seen their importance in the Klein-Gordon case). In fact, the completeness of the spinors involve all the solutions

$$\sum_{\alpha=1}^2 \left[u^{(\alpha)}(k) \bar{u}^{(\alpha)}(k) - v^{(\alpha)}(k) \bar{v}^{(\alpha)}(k) \right] = \Lambda_+(k) + \Lambda_-(k) = 1 \quad (4.123)$$

In the case of a non interacting theory there are no possibilities of transitions among positive and negative energy states but, when an interaction is turned on, such a possibility cannot be excluded. In fact, if we try to localize a Dirac particle within distances of order $1/m$ the negative energy solutions cannot be ignored. To clarify this point let us consider the time evolution of a gaussian wave packet, assigned at time $t = 0$,

$$\psi(\vec{x}, 0) = \frac{1}{(\pi d^2)^{3/4}} e^{-\frac{|\vec{x}|^2}{2d^2}} w \quad (4.124)$$

where w is a fixed spinor, $w = (\phi, 0)$, with $w^\dagger w = 1$. As one can check, the wave packet is normalized to one

$$\int d^3x \psi^\dagger \psi = \frac{1}{(\pi d^2)^{3/2}} \int d^3x e^{-\frac{|\vec{x}|^2}{d^2}}$$

$$\begin{aligned}
&= \frac{1}{(\pi d^2)^{3/2}} \prod_{i=1}^3 \int dx_i e^{-\frac{x_i^2}{d^2}} \\
&= \frac{1}{(\pi d^2)^{3/2}} \prod_{i=1}^3 (\pi d^2)^{1/2} = 1
\end{aligned} \tag{4.125}$$

The solution of the Dirac equation with this boundary condition is obtained by expanding over all the wave plane solutions

$$\psi(\vec{x}, t) = \int d^3k \frac{1}{\sqrt{(2\pi)^3}} \sqrt{\frac{m}{E}} \sum_{\alpha=1}^2 \left[b(k, \alpha) u^{(\alpha)}(k) e^{-ikx} + d^*(k, \alpha) v^{(\alpha)}(k) e^{ikx} \right] \tag{4.126}$$

and evaluating the expansion coefficients $b(k, \alpha)$ and $d^*(k, \alpha)$, by requiring that the solution coincides with eq. (4.124) at time $t = 0$. We get

$$\begin{aligned}
\psi(\vec{x}, 0) &= \int d^3k \frac{1}{\sqrt{(2\pi)^3}} \sqrt{\frac{m}{E}} \sum_{\alpha=1}^2 \left[b(k, \alpha) u^{(\alpha)}(k) + d^*(\tilde{k}, \alpha) v^{(\alpha)}(\tilde{k}) \right] e^{i\vec{k} \cdot \vec{x}} \\
&= \frac{1}{(\pi d^2)^{3/4}} e^{-\frac{|\vec{x}|^2}{2d^2}} w
\end{aligned} \tag{4.127}$$

We Fourier transform both sides of this equation, obtaining

$$\begin{aligned}
&\sqrt{(2\pi)^3} \sqrt{\frac{m}{E}} \sum_{\alpha=1}^2 \left[b(k, \alpha) u^{(\alpha)}(k) + d^*(\tilde{k}, \alpha) v^{(\alpha)}(\tilde{k}) \right] \\
&= \frac{w}{(\pi d^2)^{3/4}} \int d^3x e^{-\frac{|\vec{x}|^2}{2d^2}} e^{-i\vec{k} \cdot \vec{x}} \\
&= \frac{w}{(\pi d^2)^{3/4}} (2\pi d^2)^{3/2} e^{-\frac{|\vec{k}|^2 d^2}{2}}
\end{aligned} \tag{4.128}$$

From which

$$\sqrt{\frac{m}{E}} \sum_{\alpha=1}^2 \left[b(k, \alpha) u^{(\alpha)}(k) + d^*(\tilde{k}, \alpha) v^{(\alpha)}(\tilde{k}) \right] = \left(\frac{d^2}{\pi} \right)^{3/4} e^{-\frac{|\vec{k}|^2 d^2}{2}} w \tag{4.129}$$

Using the orthogonality relations for the spinors we find the amplitudes

$$b(k, \alpha) = \sqrt{\frac{m}{E}} \left(\frac{d^2}{\pi} \right)^{3/4} e^{-\frac{|\vec{k}|^2 d^2}{2}} u^{\dagger(\alpha)}(k) w \tag{4.130}$$

$$d^*(\tilde{k}, \alpha) = \sqrt{\frac{m}{E}} \left(\frac{d^2}{\pi} \right)^{3/4} e^{-\frac{|\vec{k}|^2 d^2}{2}} v^{\dagger(\alpha)}(\tilde{k}) w \tag{4.131}$$

Expressing u e v in terms of two-component spinors we get

$$b(k, \alpha) = \sqrt{\frac{m}{E}} \left(\frac{d^2}{\pi} \right)^{3/4} e^{-\frac{|\vec{k}|^2 d^2}{2}} \sqrt{\frac{m+E}{2m}} \phi^{(\alpha)\dagger}(m, \vec{0}) \phi \quad (4.132)$$

$$d^*(\tilde{k}, \alpha) = \sqrt{\frac{m}{E}} \left(\frac{d^2}{\pi} \right)^{3/4} e^{-\frac{|\vec{k}|^2 d^2}{2}} \frac{1}{\sqrt{2m(m+E)}} \chi^{(\alpha)\dagger}(m, \vec{0}) \vec{k} \cdot \vec{\sigma} \phi \quad (4.133)$$

from which we can evaluate the ratio of the negative energy amplitudes to the positive energy ones

$$\frac{d^*(\tilde{k}, \alpha)}{b(k, \alpha)} \approx \frac{|\vec{k}|}{m+E} \quad (4.134)$$

The amplitudes (for both signs of the energy) contribute only if $|\vec{k}| \ll 1/d$ (due to the gaussian exponential). Suppose that we want to localize the particle over distances larger than $1/m$, that is we require $d \gg 1/m$. Since the negative energy state amplitudes are important only for $|\vec{k}| > m \gg 1/d$, their contribution is depressed by the gaussian exponential. On the other hand, if we try to localize the particle over distances $d \approx 1/m$, the negative energy states contribution becomes important for values of $|\vec{k}|$ of order m , or of order $1/d$, that is in the momentum region in which the corresponding amplitudes are not negligible. We see that the physical interpretation is essentially the same following from the uncertainty principle.

4.5 Electromagnetic interaction of a relativistic point-like particle

Before continuing our discussion about the properties of the Dirac equation, let us describe the interaction of a point-like particle with the electromagnetic field in the relativistic formalism.

Let us recall that the classical expression for the electromagnetic four current is given by

$$j^\mu = (\rho, \rho \vec{v}) \quad (4.135)$$

where ρ is the charge density, and \vec{v} the velocity field. In the case of a point-like particle which follows the world line describe in a parametric form by the four functions $x^\mu(\tau)$, with τ an arbitrary line parameter, the charge density at the time t is localized at the position $\vec{x}(\tau)$, evaluated at the parameter value τ such that $t = x^0(\tau)$ (see Fig. 4.1). Therefore

$$\rho(\vec{y}, t) = e \delta^3(\vec{y} - \vec{x}(\tau))|_{t=x^0(\tau)} \quad (4.136)$$

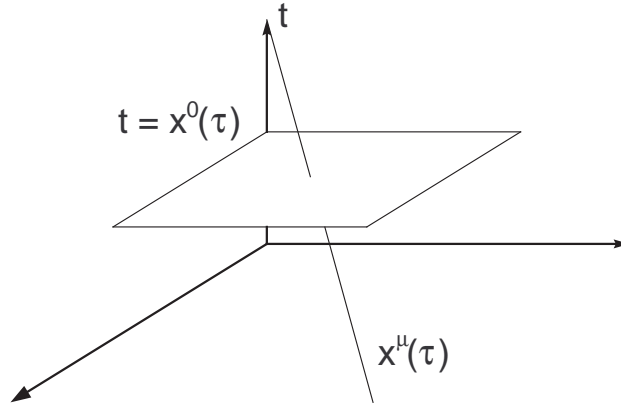

Fig. 4.1 - The space-time trajectory of a point-like particle

It follows

$$j^\mu(y) = e \frac{dx^\mu}{dx^0} \delta^3(\vec{y} - \vec{x}(\tau)) \Big|_{y^0=x^0(\tau)} \quad (4.137)$$

This expression can be put in a covariant form, after taking into account the following relation

$$\int d\tau f(\tau) \delta(y^0 - x^0(\tau)) = \left(\frac{dx^0}{d\tau} \right)^{-1} f(\tau) \Big|_{x^0(\tau)=y^0} \quad (4.138)$$

From this

$$j^\mu(y) = e \int_{-\infty}^{+\infty} d\tau \frac{dx^\mu}{d\tau} \delta^4(y - x(\tau)) \quad (4.139)$$

This four current is a conserved one:

$$\partial_\mu j^\mu(y) = -e \int_{-\infty}^{+\infty} d\tau \frac{dx^\mu}{d\tau} \frac{\partial}{\partial x^\mu} \delta^4(y - x(\tau)) = -e \int_{-\infty}^{+\infty} d\tau \frac{d}{d\tau} \delta^4(y - x(\tau)) \quad (4.140)$$

The expression vanishes at any space-time point y , except at the end points $x(\pm\infty)$.

We recall also that the equations of motion for a free relativistic scalar particle can be derived by the following action

$$S = -m \int_{\tau_i}^{\tau_f} d\tau \sqrt{\dot{x}^2}, \quad \dot{x}^\mu = \frac{dx^\mu}{d\tau} \quad (4.141)$$

We will be interested in deriving the lagrangian describing the interaction between our particle and the electromagnetic field (we assume that our particle has charge e). We should be able to derive the following equations of motion

$$\frac{d}{dt} \frac{m\vec{v}}{\sqrt{1-|\vec{v}|^2}} = e(\vec{E} + \vec{v} \wedge \vec{B}) \quad (4.142)$$

We will show that the lagrangian depends on the four-vector potential A_μ and not on the fields \vec{E} and \vec{B} . In fact we will verify that the following lagrangian reproduces

the previous equations of motion

$$\begin{aligned}
S &= -m \int_{\tau_i}^{\tau_f} d\tau \sqrt{\dot{x}^2} - \int d^4y A_\mu(y) j^\mu(y) \\
&= -m \int_{\tau_i}^{\tau_f} d\tau \sqrt{\dot{x}^2} - e \int_{\tau_i}^{\tau_f} d\tau A_\mu(x(\tau)) \dot{x}^\mu(\tau)
\end{aligned} \tag{4.143}$$

Using

$$\begin{aligned}
\frac{\partial L}{\partial x^\mu} &= -e \frac{\partial A_\nu}{\partial x^\mu} \dot{x}^\nu \\
\frac{\partial L}{\partial \dot{x}^\mu} &= -m \frac{\dot{x}_\mu}{\sqrt{\dot{x}^2}} - e A_\mu
\end{aligned} \tag{4.144}$$

and the Euler-lagrangian equations

$$\frac{\partial L}{\partial x^\mu} - \frac{d}{d\tau} \frac{\partial L}{\partial \dot{x}^\mu} = 0 \tag{4.145}$$

we get

$$-e \frac{\partial A_\nu}{\partial x^\mu} \dot{x}^\nu + m \frac{d}{d\tau} \frac{\dot{x}_\mu}{\sqrt{\dot{x}^2}} + e \frac{\partial A_\mu}{\partial x^\nu} \dot{x}^\nu = 0 \tag{4.146}$$

Therefore

$$m \frac{d}{d\tau} \frac{\dot{x}_\mu}{\sqrt{\dot{x}^2}} = e (\partial_\mu A_\nu - \partial_\nu A_\mu) \dot{x}^\nu \tag{4.147}$$

Since $ds = d\tau \sqrt{\dot{x}^2}$, where ds is the line element measured along the trajectory, we see that the four-velocity of the particle is

$$U^\mu = \frac{\dot{x}^\mu}{\sqrt{\dot{x}^2}} \tag{4.148}$$

from which we get the equations of motion in a covariant form

$$m \frac{d}{ds} U_\mu = e F_{\mu\nu} U^\nu \tag{4.149}$$

Here we have introduced the electromagnetic tensor

$$F_{\mu\nu} = \partial_\mu A_\nu - \partial_\nu A_\mu \tag{4.150}$$

Since the definition of the fields in terms of the vector and scalar potential is given by

$$\vec{E} = -\vec{\nabla} A^0 - \frac{\partial \vec{A}}{\partial t}, \quad \vec{B} = \vec{\nabla} \wedge \vec{A} \tag{4.151}$$

we get

$$\vec{E} = (F^{10}, F^{20}, F^{30}), \quad \vec{B} = (-F^{23}, -F^{31}, -F^{12}) \tag{4.152}$$

(we can also write $F^{ij} = -\epsilon_{ijk}B^k$). By choosing $\tau = x^0$ in the eq. (4.147) we find

$$m \frac{d}{dt} \frac{-v^k}{\sqrt{1-|\vec{v}|^2}} = eF_{k0} + eF_{ki} \frac{dx^i}{dt} = -eE^k - \epsilon_{kij}B^j v^i \quad (4.153)$$

reproducing eq. (4.142).

There are various ways to convince oneself about the necessity of the appearance of the four potential inside the lagrangian. For instance, consider the Maxwell equations

$$\partial^\mu F_{\mu\nu} = j_\nu, \quad \partial^\mu \tilde{F}_{\mu\nu} = 0 \quad (4.154)$$

where $\tilde{F}_{\mu\nu} = \frac{1}{2}\epsilon_{\mu\nu\rho\sigma}F^{\rho\sigma}$ is the dual tensor (we define the Ricci tensor in 4 dimensions, through $\epsilon^{0123} = +1$). In Section 3.2 we have shown how to deduce the expression for the lagrangian multiplying the field equations by an infinitesimal variation of the fields. In the actual case, to consider $F_{\mu\nu}$ as the fields to be varied, would create a problem because multiplying both sides of the Maxwell equations by $\delta F_{\mu\nu}$ we do not get a Lorentz scalar. This difficulty is avoided by taking A_μ as the independent degrees of freedom of the theory (we will show in the following that also this point of view has its own difficulties). In this case, due to the definition (4.150) of the electromagnetic tensor, the homogeneous Maxwell equations become identities (in fact, it is just solving these equations that one originally introduces the vector and the scalar potentials)

$$\tilde{F}_{\mu\nu} = \epsilon_{\mu\nu\rho\sigma}\partial^\rho A^\sigma \implies \partial^\mu \tilde{F}_{\mu\nu} = 0 \quad (4.155)$$

whereas the inhomogeneous ones give rise to

$$\partial^\mu(\partial_\mu A_\nu - \partial_\nu A_\mu) = \partial^2 A_\nu - \partial_\nu \partial^\mu A_\mu = j_\nu \quad (4.156)$$

The previous difficulty disappears because $j_\mu \delta A^\mu$ is a Lorentz scalar. By regarding j_μ as a given external current, independent on A_μ , we can now get easily the expression for the lagrangian. By multiplying eq. (4.156) by δA^ν and integrating in d^4x we get

$$\begin{aligned} 0 &= \int_V d^4x \delta A^\nu (\partial^2 A_\nu - \partial_\nu \partial^\mu A_\mu - j_\nu) \\ &= \int_V d^4x \left[-\delta(\partial_\mu A_\nu) \partial^\mu A^\nu + \partial_\mu (\delta A^\nu \partial^\mu A_\nu) \right. \\ &\quad \left. + \delta(\partial_\mu A_\nu) \partial^\nu A^\mu - \partial_\mu (\delta A^\nu \partial_\nu A^\mu) - \delta(A^\mu j_\mu) \right] \\ &= \int_V d^4x \left[-\frac{1}{2} \delta(\partial_\mu A_\nu) \partial^\mu A^\nu - \frac{1}{2} \delta(\partial_\nu A_\mu) \partial^\nu A^\mu \right. \\ &\quad \left. + \frac{1}{2} \delta(\partial_\mu A_\nu) \partial^\nu A^\mu + \frac{1}{2} \delta(\partial_\nu A_\mu) \partial^\mu A^\nu - \delta(A^\mu j_\mu) \right] + \text{surface terms} \\ &= -\frac{1}{2} \int_V d^4x (\delta F_{\mu\nu}) F^{\mu\nu} - \int_V d^4x \delta(A^\mu j_\mu) + \text{surface terms} \\ &= \delta \left[\int_V d^4x \left(-\frac{1}{4} F_{\mu\nu} F^{\mu\nu} - A^\mu j_\mu \right) \right] + \text{surface terms} \end{aligned} \quad (4.157)$$

We see that the action for an electromagnetic field interacting with an external current j^μ is given by (here $F_{\mu\nu}$ must be thought as a function of A_μ)

$$S = -\frac{1}{4} \int_V d^4x F_{\mu\nu} F^{\mu\nu} - \int_V d^4x j_\mu A^\mu \quad (4.158)$$

Notice that the interacting term has the same structure we found for the point-like particle.

We stress again that the A_μ 's are the canonical variables of the electrodynamics. In principle, one could reintroduce the fields by inverting the relations between fields and potentials. However, in this way, one would end up with a non-local action. From these considerations one can argue that the potentials play an important role in quantum mechanics, much more than in the classical case, where they are essentially a convenient trick. Recall also that the canonical variables satisfy local commutation relations (the commutator vanishes at space-like distances), implying that local observables should be local functions of the potentials. This is going to create us some problem, because the theory is invariant under gauge transformations, whereas the potentials are not

$$A_\mu(x) \rightarrow A_\mu(x) + \partial_\mu \Lambda(x) \quad (4.159)$$

(where $\Lambda(x)$ is an arbitrary function). Therefore, the observables of the theory should be gauge invariant. This implies that the potentials cannot be observed. An example of observable local in the potentials is the electromagnetic tensor $F_{\mu\nu}$.

The pure electromagnetic part of the action (4.158) is naively gauge invariant, being a function of $F_{\mu\nu}$. As far as the interaction term is concerned we have (assuming that the current is gauge invariant)

$$j_\mu A^\mu \rightarrow j_\mu A^\mu + j_\mu \partial^\mu \Lambda = j_\mu A^\mu + \partial^\mu (j_\mu \Lambda) - (\partial^\mu j_\mu) \Lambda \quad (4.160)$$

Adding a four divergence to the lagrangian density does not change the equations of motion

$$\int_{t_1}^{t_2} dt \int d^3x \partial_\mu \chi^\mu = \int_{t_1}^{t_2} dt \frac{\partial}{\partial t} \int d^3x \chi^0 \quad (4.161)$$

Therefore the invariance of the lagrangian under gauge transformations (neglecting a four divergence) is guaranteed, if the potentials are coupled to a gauge invariant and conserved current

$$\partial^\mu j_\mu = 0 \quad (4.162)$$

We have shown that this condition is indeed satisfied for the point-like particle.

In order to derive the general prescription to couple the electromagnetic potentials to a charged particle, let us go back to the action for the point-like particle. This prescription is known as the **minimal substitution**. By choosing $x^0 = \tau$ in (4.143), we get

$$L = -m\sqrt{1 - |\vec{v}|^2} - e(A^0 - \vec{v} \cdot \vec{A}) \quad (4.163)$$

from which

$$\vec{p} = \frac{\partial L}{\partial \vec{v}} = \frac{m\vec{v}}{\sqrt{1 - |\vec{v}|^2}} + e\vec{A} \quad (4.164)$$

The hamiltonian is obtained through the usual Legendre transform

$$\begin{aligned} H &= \vec{p} \cdot \vec{v} - L = m \frac{|\vec{v}|^2}{\sqrt{1 - |\vec{v}|^2}} + e\vec{v} \cdot \vec{A} + m\sqrt{1 - |\vec{v}|^2} + e(A^0 - \vec{v} \cdot \vec{A}) \\ &= \frac{m}{\sqrt{1 - |\vec{v}|^2}} + eA_0 \end{aligned} \quad (4.165)$$

Therefore, we get the following relations

$$\vec{p} - e\vec{A} = m \frac{\vec{v}}{\sqrt{1 - |\vec{v}|^2}}, \quad H - eA^0 = \frac{m}{\sqrt{1 - |\vec{v}|^2}} \quad (4.166)$$

where the quantities in the left hand sides are the same as in the free case. It follows that we can go from the free case to the interacting one, by the simple substitution (minimal substitution)

$$p^\mu \rightarrow p^\mu - eA^\mu \quad (4.167)$$

In the free case, inverting the relations between momenta and velocities

$$|\vec{v}|^2 = \frac{|\vec{p}|^2}{m^2 + |\vec{p}|^2}, \quad 1 - |\vec{v}|^2 = \frac{m^2}{m^2 + |\vec{p}|^2} \quad (4.168)$$

we get the hamiltonian as a function of the canonical momenta

$$H_{\text{free}} = \sqrt{m^2 + |\vec{p}|^2} \quad (4.169)$$

By performing the minimal substitution we get

$$H - eA^0 = \sqrt{m^2 + (\vec{p} - e\vec{A})^2} \quad (4.170)$$

from which

$$H = eA^0 + \sqrt{m^2 + (\vec{p} - e\vec{A})^2} \quad (4.171)$$

which is nothing but eq. (4.165), after using eq. (4.164). From the point of view of canonical quantization, the minimal substitution corresponds to the following substitution in the derivatives

$$\partial^\mu \rightarrow \partial^\mu + ieA^\mu \quad (4.172)$$

4.6 Non relativistic limit of the Dirac equation

In order to understand better the role of the spin in the Dirac equation we will study now the non relativistic limit in presence of an electromagnetic field.

$$(i\hat{\partial} - m)\psi(x) = 0 \implies (i\hat{\partial} - e\hat{A} - m)\psi(x) = 0 \quad (4.173)$$

Notice that the Dirac equation is invariant under the transformation (4.159)

$$A_\mu(x) \rightarrow A_\mu(x) + \partial_\mu\alpha(x) \quad (4.174)$$

if we perform also the following local phase transformation on the wave function

$$\psi(x) \rightarrow e^{-ie\alpha(x)}\psi(x) \quad (4.175)$$

Also, eq. (4.173) is invariant under Lorentz transformations, if in going from the frame S to the frame S' ($x \rightarrow x' = \Lambda x$), the field A_μ is transformed as

$$A_\mu(x) \rightarrow A'_\mu(x') = (\Lambda^{-1})^\nu{}_\mu A_\nu(x) \quad (4.176)$$

that is if $A_\mu(x)$ transforms as ∂_μ :

$$\frac{\partial}{\partial x^\mu} \rightarrow \frac{\partial}{\partial x'^\mu} = \frac{\partial x^\nu}{\partial x'^\mu} \frac{\partial}{\partial x^\nu} = (\Lambda^{-1})^\nu{}_\mu \partial_\nu \quad (4.177)$$

Eq. (4.176) says simply that A_μ transforms as a four vector under Lorentz transformations.

In order to study the non relativistic limit is better to write $\psi(x)$ in the following form

$$\psi(x) = \begin{bmatrix} \tilde{\phi}(x) \\ \tilde{\chi}(x) \end{bmatrix} \quad (4.178)$$

where $\tilde{\phi}(x)$ and $\tilde{\chi}(x)$ are two-component spinors. By defining

$$\vec{\pi} = \vec{p} - e\vec{A} \quad (4.179)$$

and using the representation in 2×2 blocks of the Dirac matrices given in eq. (4.11), we get

$$i \frac{\partial}{\partial t} \begin{bmatrix} \tilde{\phi}(x) \\ \tilde{\chi}(x) \end{bmatrix} = \begin{bmatrix} 0 & \vec{\sigma} \cdot \vec{\pi} \\ \vec{\sigma} \cdot \vec{\pi} & 0 \end{bmatrix} \begin{bmatrix} \tilde{\phi}(x) \\ \tilde{\chi}(x) \end{bmatrix} + \begin{bmatrix} m & 0 \\ 0 & -m \end{bmatrix} \begin{bmatrix} \tilde{\phi}(x) \\ \tilde{\chi}(x) \end{bmatrix} + eA^0 \begin{bmatrix} \tilde{\phi}(x) \\ \tilde{\chi}(x) \end{bmatrix} \quad (4.180)$$

This gives rise to two coupled differential equations

$$\begin{aligned} i \frac{\partial \tilde{\phi}}{\partial t} &= \vec{\sigma} \cdot \vec{\pi} \tilde{\chi} + (m + eA^0) \tilde{\phi} \\ i \frac{\partial \tilde{\chi}}{\partial t} &= \vec{\sigma} \cdot \vec{\pi} \tilde{\phi} - (m - eA^0) \tilde{\chi} \end{aligned} \quad (4.181)$$

In the non relativistic limit, and for weak fields, the mass term is the dominant one, and the energy positive solution will behave roughly as e^{-imt} . With this consideration in mind we put

$$\begin{bmatrix} \tilde{\phi}(x) \\ \tilde{\chi}(x) \end{bmatrix} = e^{-imt} \begin{bmatrix} \phi(x) \\ \chi(x) \end{bmatrix} \quad (4.182)$$

with ϕ and χ functions slowly variable in time. In this way we obtain

$$\begin{aligned} i \frac{\partial \phi}{\partial t} &= \vec{\sigma} \cdot \vec{\pi} \chi + eA^0 \phi \\ i \frac{\partial \chi}{\partial t} &= \vec{\sigma} \cdot \vec{\pi} \phi - (2m - eA^0) \chi \end{aligned} \quad (4.183)$$

Assuming $eA^0 \ll 2m$, and $\partial\chi/\partial t \approx 0$ we have

$$\chi \approx \frac{\vec{\sigma} \cdot \vec{\pi}}{2m} \phi \quad (4.184)$$

from which

$$i \frac{\partial \phi}{\partial t} = \left[\frac{(\vec{\sigma} \cdot \vec{\pi})^2}{2m} + eA^0 \right] \phi \quad (4.185)$$

One must be careful in evaluating $(\vec{\sigma} \cdot \vec{\pi})^2$, since the components of the vector $\vec{\pi}$ do not commute among themselves. In fact

$$[\pi^i, \pi^j] = [p^i - eA^i, p^j - eA^j] = ie \frac{\partial A^j}{\partial x^i} - ie \frac{\partial A^i}{\partial x^j} \quad (4.186)$$

where we have made use of

$$[p^i, f(\vec{x})] = -i \frac{\partial f(\vec{x})}{\partial x^i} \quad (4.187)$$

From $\vec{B} = \vec{\nabla} \wedge \vec{A}$ it follows

$$[\pi^i, \pi^j] = ie \epsilon_{ijk} B^k \quad (4.188)$$

and

$$\begin{aligned} (\vec{\sigma} \cdot \vec{\pi})^2 &= \sigma_i \sigma_j \pi^i \pi^j = \left(\frac{1}{2} [\sigma_i, \sigma_j] + \frac{1}{2} [\sigma_i, \sigma_j]_+ \right) \pi^i \pi^j \\ &= |\vec{\pi}|^2 + \frac{1}{2} [\sigma_i, \sigma_j] \pi^i \pi^j = |\vec{\pi}|^2 + \frac{1}{4} [\sigma_i, \sigma_j] [\pi^i, \pi^j] \\ &= |\vec{\pi}|^2 + \frac{i}{2} \epsilon_{ijk} \sigma_k (ie) \epsilon_{ijl} B^l \end{aligned} \quad (4.189)$$

Finally

$$(\vec{\sigma} \cdot \vec{\pi})^2 = |\vec{\pi}|^2 - e \vec{\sigma} \cdot \vec{B} \quad (4.190)$$

The equation for ϕ becomes

$$i\frac{\partial\phi}{\partial t} = \left[\frac{(\vec{p} - e\vec{A})^2}{2m} - \frac{e}{2m}\vec{\sigma} \cdot \vec{B} + eA^0 \right] \phi \quad (4.191)$$

This is nothing but the Pauli equation for an electron interacting with an electromagnetic field. In particular, the term proportional to the magnetic field represents the interaction with a magnetic dipole given by

$$\vec{\mu} = \frac{e}{2m}\vec{\sigma} = \frac{e}{m}\vec{S} \quad (4.192)$$

where we have introduced the spin matrices $\vec{S} = \vec{\sigma}/2$. This shows that the Dirac equation predicts a gyromagnetic ratio equal to two. We may see this also in a slightly different way, by considering the interaction with an uniform and weak magnetic field. In this case the vector potential is given by

$$\vec{A} = \frac{1}{2}\vec{B} \wedge \vec{x} \quad (4.193)$$

Neglecting the quadratic term in the fields we have

$$(\vec{p} - e\vec{A})^2 \approx |\vec{p}|^2 - e(\vec{p} \cdot \vec{A} + \vec{A} \cdot \vec{p}) \quad (4.194)$$

Using

$$\sum_i [p^i, A^i] = -i\vec{\nabla} \cdot \vec{A} = 0 \quad (4.195)$$

it follows

$$\begin{aligned} (\vec{p} - e\vec{A})^2 &\approx |\vec{p}|^2 - 2e\vec{p} \cdot \vec{A} = |\vec{p}|^2 - e\vec{p} \cdot (\vec{B} \wedge \vec{x}) \\ &= |\vec{p}|^2 - ep^i \epsilon_{ijk} B^j x^k = |\vec{p}|^2 - e\epsilon_{kij} x^k p^i B^j \\ &= |\vec{p}|^2 - e(\vec{x} \wedge \vec{p}) \cdot \vec{B} = |\vec{p}|^2 - e\vec{L} \cdot \vec{B} \end{aligned} \quad (4.196)$$

and finally

$$i\frac{\partial\phi}{\partial t} = \left[\frac{|\vec{p}|^2}{2m} - \frac{e}{2m}(\vec{L} + 2\vec{S}) \cdot \vec{B} + eA^0 \right] \phi \quad (4.197)$$

which shows explicitly the value of the gyromagnetic ratio. Experimentally this is very close to two, and we shall see, in the following, that the difference is explained by the quantum electrodynamics (QED). This is in fact, one of the biggest successes of this theory. However, let us notice that, from the point of view of the Dirac equation, to find a value of the gyromagnetic ratio so close to the experimental value is not a real prediction. In fact, one could think to add to the theory a further interaction term of the kind $F_{\mu\nu}\bar{\psi}\sigma^{\mu\nu}\psi$. This term is both Lorentz and gauge invariant. It is also possible to show that such a term gives a contribution to the magnetic moment of the electron, and therefore it changes the gyromagnetic ratio. We shall see that the requirement that QED is a finite theory forbids, in fact, the appearance of such a term.

4.7 Charge conjugation, time reversal and PCT transformation

Dirac equation had a great success in explaining the fine structure of the hydrogen atom, but the problem of negative energy solutions, that, in principle, make the theory unstable, was still there. Dirac looked for a solution to this problem by taking advantage of the exclusion Pauli principle, which applies to half-integer spin particles. Dirac made the hypothesis that all the negative energy states were occupied by electrons. In such a situation, the Pauli principle forbids to any electron in a positive energy state to make a transition to a negative energy state. This solves the stability problem, but at the same time new phenomena may happen. For, instance, an electron in a negative energy state could get enough energy (bigger than $2m$ which is the minimal energy gap between the negative and positive energy states) to make a transition to a state of positive energy. If we imagine that in the state of energy $-E$ are present N electrons (we are simplifying things, because due to the momentum degeneracy there actually an infinite number of electrons), and that one of these electrons undergoes the transition, the energy of the state changes as follows

$$\mathcal{E} - NE \rightarrow \mathcal{E} - (N - 1)E = \mathcal{E} - NE + E \quad (4.198)$$

where \mathcal{E} is the energy of all the other electrons (with energy different from $-E$) in the fundamental state. Notice that in the Dirac theory the fundamental state is the one with all the negative energy states occupied and zero electrons in the energy positive states. In a sense this is the physical explanation of the infinite energy of the vacuum that we found in the case of the Klein-Gordon field, and one finds also for the Dirac case (see later). In a complete analogous way, also the charge of the vacuum is infinite and its variation in the previous transition is given by

$$\mathcal{Q} + Ne \rightarrow \mathcal{Q} + (N - 1)e = \mathcal{Q} + Ne - e \quad (4.199)$$

where e is the charge of the electron ($e < 0$). We see that the vacuum energy and the charge increase respectively by E and $-e$ in the transition. We can interpret this by saying that the hole left in the vacuum by the electron has charge $-e$ and energy E . That is we can think to the hole being a particle of positive energy and positive charge. This is the way in which the idea of antiparticles came around. That the hole is thought as the antiparticle of the electron. The transition of an electron of negative energy to a state of positive energy is then seen as the creation of particle antiparticle (the hole) pair. In the same way, once we have a hole in the vacuum, it may happen that a positive energy electron makes a transition to the hole state. In this case both the electron and the hole disappears. This is the pair annihilation phenomenon. Of course this happens with some energy released, that usually is under electromagnetic form.

The hole theory is nowadays reinterpreted in terms of antiparticles, but this way of thinking has been extremely fruitful in many fields, as the study of electrons in metals, in nuclear physics and so on.

Assuming seriously the hole theory means that the Dirac equation should admit, beyond the positive energy solutions corresponding to an electron, other positive energy solutions with the same mass of the electron, but with opposite charge. To see this point in a formal way, we look for a transformation of the electron wave function, $\psi(x)$, to the antielectron (positron) wave function $\psi^C(x)$, such that, if ψ satisfies

$$(i\hat{\partial} - e\hat{A} - m)\psi(x) = 0 \quad (4.200)$$

then ψ^C satisfies

$$(i\hat{\partial} + e\hat{A} - m)\psi^C(x) = 0 \quad (4.201)$$

We will require that the transformation is a local one, and that the transformed of the antiparticle wave function gives back, except for a possible phase factor, the electron wave function. To build up ψ^C we will start by taking the complex conjugate of ψ . This is clearly the only possibility to change a negative energy solution, described by e^{iEt} , in a positive energy solution, described by e^{-iEt} . By taking the hermitian conjugate, multiplying by γ_0 and transposing, we get

$$\begin{aligned} (i\hat{\partial} - e\hat{A} - m)\psi(x) = 0 &\rightarrow -i\partial^\mu \bar{\psi} \gamma_\mu - e\bar{\psi} \hat{A} - m\bar{\psi} = 0 \\ &\rightarrow [\gamma^{\mu T}(-i\partial_\mu - eA_\mu) - m]\bar{\psi}^T = 0 \end{aligned} \quad (4.202)$$

where

$$\bar{\psi}^T = \gamma_0^T \psi^\star \quad (4.203)$$

If there exists a matrix, C , such that

$$C\gamma_\mu^T C^{-1} = -\gamma_\mu \quad (4.204)$$

multiplying eq. (4.202) by C , we get

$$(i\hat{\partial} + e\hat{A} - m)C\bar{\psi}^T = 0 \quad (4.205)$$

This describes a particle with charge $-e$, therefore, apart a phase factor η_C , we can identify ψ^C with $C\bar{\psi}^T$:

$$\psi^C = \eta_C C\bar{\psi}^T \quad (4.206)$$

In the representation where γ_0 is diagonal we have

$$\gamma_0^T = \gamma_0, \quad \gamma_1^T = -\gamma_1, \quad \gamma_2^T = \gamma_2, \quad \gamma_3^T = -\gamma_3 \quad (4.207)$$

It is enough to choose C such to commute with γ_1 and γ_2 and anticommute with γ_0 and γ_3 . It follows that C must be proportional to $\gamma_2\gamma_0$. Let us choose

$$C = i\gamma^2\gamma^0 = \begin{pmatrix} 0 & -i\sigma_2 \\ -i\sigma_2 & 0 \end{pmatrix} \quad (4.208)$$

In this way, C satisfies

$$-C = C^{-1} = C^T = C^\dagger \quad (4.209)$$

To understand how the transformation works let us consider, in the rest frame, a negative energy solution with spin down

$$\psi^{(-)} = e^{imt} \begin{pmatrix} 0 \\ 0 \\ 0 \\ 1 \end{pmatrix} \quad (4.210)$$

Then

$$\begin{aligned} \psi^{(-)C} &= \eta_C C \bar{\psi}^T = \eta_C C \gamma_0 \psi^{(-)\star} = \eta_C i \gamma^2 \psi^{(-)\star} \\ &= \eta_C e^{-imt} \begin{pmatrix} 0 & 0 & 0 & 1 \\ 0 & 0 & -1 & 0 \\ 0 & -1 & 0 & 0 \\ 1 & 0 & 0 & 0 \end{pmatrix} \begin{pmatrix} 0 \\ 0 \\ 0 \\ 1 \end{pmatrix} \end{aligned} \quad (4.211)$$

and

$$\psi_{down}^{(-)C} = \eta_C e^{-imt} \begin{pmatrix} 1 \\ 0 \\ 0 \\ 0 \end{pmatrix} = \eta_C \psi_{up}^{(+)} \quad (4.212)$$

That is, given an energy negative wave function describing an electron with spin down, its charge conjugated is a positive energy wave function describing a positron with spin up. For an arbitrary solution with defined energy and spin, by using the projectors of Section 4.3, we write

$$\psi = \frac{\epsilon \hat{p} + m}{2m} \frac{1 + \gamma_5 \hat{n}}{2} \psi \quad (4.213)$$

where $p_0 > 0$. $\epsilon = \pm 1$ selects the energy sign. Noticing that C commutes with γ_5 , that $\gamma_5^\star = \gamma_5$, and that

$$\gamma^0 \gamma^{\mu\star} \gamma^0 = \gamma^{\mu T} \quad (4.214)$$

following from

$$\gamma^0 \gamma^{\mu\dagger} \gamma^0 = \gamma^\mu \quad (4.215)$$

we obtain

$$\begin{aligned} \psi^C &= \eta_C C \gamma_0 \frac{\epsilon \hat{p}^\star + m}{2m} \frac{1 + \gamma_5 \hat{n}^\star}{2} \psi^\star = \eta_C C \frac{\epsilon \hat{p}^T + m}{2m} \frac{1 - \gamma_5 \hat{n}^T}{2} \gamma^0 \psi^\star \\ &= \frac{-\epsilon \hat{p} + m}{2m} \frac{1 + \gamma_5 \hat{n}}{2} \psi^C \end{aligned} \quad (4.216)$$

We see that ψ^C is described by the same four vectors p^μ and n^μ appearing in ψ , but with opposite sign of the energy. Then

$$u(p, n) = \eta_C v^C(p, n), \quad v(p, n) = \eta_C u^C(p, n) \quad (4.217)$$

Since the spin projector selects the states of spin $\pm 1/2$ along \vec{n} according to the sign of the energy, it follows that the charge conjugation inverts the spin projection of the particle. Notice also that, being ψ^C a solution of the Dirac equation with $e \rightarrow -e$, it follows that the following transformation

$$\psi \rightarrow \psi^C, \quad A_\mu \rightarrow -A_\mu \quad (4.218)$$

is a symmetry of the Dirac equation. Because we change sign to the four-potential, we say also that the photon has charge conjugation -1.

The last discrete transformation we will consider here is the time reversal. The physical meaning of this transformation can be illustrated in terms of a movie were we record all the observations made on the state described by the wave function $\psi(x)$. If we run the movie backward and we see a series of observations which are physically doable, we say that the theory is invariant under time reversal. From a mathematical point of view we have the time reversal symmetry if, sending $t \rightarrow t' = -t$, it is possible to transform the wave function in such a way that it satisfies the original Dirac equation. If this happens, the transformed wave function describes an electron propagating backward in time. To build up explicitly the time reversal transformation, let us consider the electron in interaction with the electromagnetic field. It is convenient to write the Dirac equation in hamiltonian form (see eq. (4.6))

$$i \frac{\partial \psi(\vec{x}, t)}{\partial t} = H \psi(\vec{x}, t) \quad (4.219)$$

with

$$H = eA^0 + \gamma^0 \vec{\gamma} \cdot (-i\vec{\nabla} - e\vec{A}) + \gamma^0 m \quad (4.220)$$

Let us define our transformation through the following equation

$$\psi'(\vec{x}, t') = K \psi(\vec{x}, t), \quad t' = -t \quad (4.221)$$

From eq. (4.219), omitting the spatial argument

$$i \frac{\partial}{\partial t} K^{-1} \psi'(t') = H K^{-1} \psi'(t') \quad (4.222)$$

Multiplying this equation by K we get

$$\frac{\partial}{\partial t'} K(-i) K^{-1} \psi'(t') = K H K^{-1} \psi'(t') \quad (4.223)$$

The invariance can be realized in two ways

$$K(-i)K^{-1} = i; \quad K H K^{-1} = H \quad (4.224)$$

or

$$K(-i)K^{-1} = -i; \quad K H K^{-1} = -H \quad (4.225)$$

The second possibility can be excluded immediately, since under time reversal we have

$$\vec{\nabla} \rightarrow \vec{\nabla}, \quad \vec{A} \rightarrow -\vec{A}, \quad A^0 \rightarrow A^0 \quad (4.226)$$

As it follows recalling that the vector potential is generated by a distribution of currents (changing sign under time reversal), whereas the scalar potential is generated by a distribution of charges. Let us put

$$K = T (4 \times 4 \text{ matrix}) \times (\text{complexconjugation}) \quad (4.227)$$

Then, we get from eq. (4.223)

$$i \frac{\partial}{\partial t'} \psi'(t') = TH^*T^{-1} \psi'(t') \quad (4.228)$$

with

$$TH^*T^{-1} = H \quad (4.229)$$

By taking into account the transformation properties of the potentials we get

$$TH^*T^{-1} = T(eA'_0 + (\gamma_0 \vec{\gamma})^* \cdot (i\vec{\nabla} + e\vec{A}') + \gamma_0^* m)T^{-1} \quad (4.230)$$

Since we want to reproduce H we need a matrix T such that

$$T\gamma_0(\vec{\gamma})^*T^{-1} = -\gamma_0\vec{\gamma}, \quad T\gamma_0T^{-1} = \gamma_0 \quad (4.231)$$

where we have used the reality properties of γ_0 . In conclusion, T must commute with γ_0 and satisfy

$$T\vec{\gamma}^*T^{-1} = -\vec{\gamma} \quad (4.232)$$

In our representation, the matrices γ^1 and γ^3 are real, whereas γ^2 is pure imaginary. Therefore

$$T\gamma^0T^{-1} = \gamma^0, \quad T\gamma^1T^{-1} = -\gamma^1, \quad T\gamma^2T^{-1} = \gamma^2, \quad T\gamma^3T^{-1} = -\gamma^3 \quad (4.233)$$

By choosing arbitrary the phase, we put

$$T = i\gamma^1\gamma^3 \quad (4.234)$$

With this choice T satisfies

$$T^\dagger = T, \quad T^2 = 1 \quad (4.235)$$

To understand the correspondence with the classical results, where momentum and angular momentum change sign under time reversal, let us study how a positive energy solution transforms:

$$\begin{aligned} K \left[\frac{\hat{p} + m}{2m} \frac{1 + \gamma_5 \hat{n}}{2} \psi(t) \right] &= T \left[\frac{\hat{p}^* + m}{2m} \frac{1 + \gamma_5 \hat{n}^*}{2} \right] \psi^*(t) \\ &= T \left[\frac{\hat{p}^* + m}{2m} \right] T^{-1} T \left[\frac{1 + \gamma_5 \hat{n}^*}{2} \right] T^{-1} T \psi^*(t) \\ &= \frac{\hat{p} + m}{2m} \frac{1 + \gamma_5 \hat{n}}{2} \psi'(t') \end{aligned} \quad (4.236)$$

where, again $t' = -t$, and

$$\tilde{p} = (p^0, -\vec{p}), \quad \tilde{n} = (n^0, -\vec{n}) \quad (4.237)$$

The three discrete symmetry operations described so far, parity, P , charge conjugation, C , and time reversal, (T), can be combined together into a symmetry transformation called PCT . Omitting all the phases, this transformation is rather simple

$$\psi_{PCT}(-x) = PC[\overline{K\psi(x)}]^T = PC\gamma_0(K\psi(x))^* = i\gamma^0\gamma^2(-i\gamma^{1*}\gamma^{3*})\psi(x) = i\gamma_5\psi(x) \quad (4.238)$$

and it suggests a simple correspondence between the wave function of a positron moving backward in time ($\psi_{PCT}(-x)$), and the electron wave function. For a free particle of negative energy we have

$$\begin{aligned} \psi_{PCT}(-x) &= i\gamma_5 \frac{-\hat{p} + m}{2m} \frac{1 + \gamma_5 \hat{n}}{2} \psi(x) \\ &= \frac{\hat{p} + m}{2m} \frac{1 - \gamma_5 \hat{n}}{2} (i\gamma_5 \psi(x)) = \frac{\hat{p} + m}{2m} \frac{1 - \gamma_5 \hat{n}}{2} \psi_{PCT}(-x) \end{aligned} \quad (4.239)$$

Comparison with eq. (4.216), giving the charge conjugated of an energy negative state

$$\psi^C = \frac{\hat{p} + m}{2m} \frac{1 + \gamma_5 \hat{n}}{2} \psi^C \quad (4.240)$$

we see that the two expressions differ only in the spin direction. Similar conclusion can be reached by starting from the Dirac equation multiplied by $i\gamma_5$. We get ($x' = -x$, and $A'(x') = A(x)$)

$$\begin{aligned} i\gamma_5(i\hat{\partial}_x - e\hat{A}(x) - m)\psi(x) &= (-i\hat{\partial}_x + e\hat{A}(x) - m)\psi_{PCT}(x') \\ &= (i\hat{\partial}_{x'} + e\hat{A}(x') - m)\psi_{PCT}(x') \end{aligned} \quad (4.241)$$

showing that a positron moving backward in time satisfies the same equation as an electron moving forward. Eq. (4.241) tells us that the PCT transformation on ψ , combined with the PCT transformation on the four-vector potential, that is $A_\mu(x) \rightarrow -A_\mu(-x)$, is a symmetry of the theory.

The interpretation of the positrons as negative energy electrons moving backward in time is the basis of the positron theory formulated by Stückelberg and Feynman. In this approach it is possible to formulate the scattering theory without using field theory. In fact, the pair creation and pair annihilation processes can be reinterpreted in terms of scattering processes among electrons moving forward and backward in time.

4.8 Dirac field quantization

In this Section we abandon the study of the Dirac wave equation thought as a generalization of the Schrödinger equation, due to its difficulties to cope with many

particle states. We will adopt here the point of view of the quantum field theory. That is the relativistic equation is the equation describing the field operator. However, we have shown in the Klein-Gordon case, that after quantization we get a many particle system satisfying Bose-Einstein statistics. On the other hand we have seen that the Dirac equation describes spin 1/2 particles, which should satisfy the Fermi-Dirac statistics. It is quite clear that we will run into troubles insisting in quantizing the Dirac field as we did for the Klein-Gordon case. However, in order to understand the problems and the way to deal with them, we will follow the canonical way of quantization, showing that this leads to problems with the positivity of the energy. Looking for a solution of this problem we will find also the solution to the problem of the wrong statistics.

We will begin our study by looking for the action giving rise to the Dirac equation. We will take the quantities ψ and $\bar{\psi}$ as independent ones. Following the usual procedure, we multiply the Dirac equation by $\delta\bar{\psi}$ (in such a way to form a Lorentz scalar) and integrate over the space-time volume V

$$0 = \int_V d^4x \delta\bar{\psi}(i\hat{\partial} - m)\psi = \delta \int_V d^4x \bar{\psi}(i\hat{\partial} - m)\psi \quad (4.242)$$

We will assume the following action

$$S = \int_V d^4x \bar{\psi}(i\hat{\partial} - m)\psi \quad (4.243)$$

It is simply verified that this action gives rise to the correct equation of motion for $\bar{\psi}$. In fact,

$$\frac{\partial\mathcal{L}}{\partial\psi} = -m\bar{\psi}, \quad \frac{\partial\mathcal{L}}{\partial\psi_{,\mu}} = \bar{\psi}i\gamma^\mu \quad (4.244)$$

from which

$$-m\bar{\psi} - i\partial_\mu\bar{\psi}\gamma^\mu = 0 \quad (4.245)$$

The canonical momenta result to be

$$\Pi_\psi = \frac{\partial\mathcal{L}}{\partial\dot{\psi}} = i\psi^\dagger, \quad \Pi_{\psi^\dagger} = \frac{\partial\mathcal{L}}{\partial\dot{\psi}^\dagger} = 0 \quad (4.246)$$

The canonical momenta do not depend on the velocities. In principle, this creates a problem in going to the hamiltonian formalism. In fact a rigorous treatment requires an extension of the classical hamiltonian treatment, which was performed by Dirac himself. In this particular case, the result one gets is the same as proceeding in a naive way. For this reason we will avoid to describe this extension, and we will proceed as in the standard case. Then the hamiltonian density turns out to be

$$\mathcal{H} = \Pi_\psi\dot{\psi} - \mathcal{L} = i\psi^\dagger\dot{\psi} - \bar{\psi}(i\gamma^0\partial_0 + i\gamma^k\partial_k - m)\psi = \psi^\dagger(-i\vec{\alpha} \cdot \vec{\nabla} + \beta m)\psi \quad (4.247)$$

If one makes use of the Dirac equation, it is possible to write the hamiltonian density as

$$\mathcal{H} = \psi^\dagger i \frac{\partial\psi}{\partial t} \quad (4.248)$$

Contrarily to the Klein-Gordon case (see eq. (3.100)), the hamiltonian density is not positive definite. Let us recall the general expression for the energy momentum tensor (see eq. 3.84)

$$T_\nu^\mu = \frac{\partial \mathcal{L}}{\partial \phi_{,\mu}^i} \phi_{,\nu}^i - g_\nu^\mu \mathcal{L} \quad (4.249)$$

In our case we get

$$T_\nu^\mu = i\bar{\psi}\gamma^\mu\psi_{,\nu} - g_\nu^\mu(\bar{\psi}(i\hat{\partial} - m)\psi) \quad (4.250)$$

and using the Dirac equation

$$T_\nu^\mu = i\bar{\psi}\gamma^\mu\psi_{,\nu} \quad (4.251)$$

We verify immediately that this expression has vanishing four divergence. Also

$$T_k^0 = i\psi^\dagger\partial_k\psi \quad (4.252)$$

from which we get the momentum of the field

$$P^k = \int d^3x T^{0k} \implies \vec{P} = -i \int d^3x \psi^\dagger \vec{\nabla} \psi \quad (4.253)$$

In analogous way, by using the general expression for the angular momentum density (see eq. (3.96))

$$\mathcal{M}_{\rho\nu}^\mu = x_\rho T_\nu^\mu - x_\nu T_\rho^\mu - \frac{\partial \mathcal{L}}{\partial \phi_{,\mu}^i} \Sigma_{\rho\nu}^{ij} \phi^j \quad (4.254)$$

The matrices $\Sigma_{\mu\nu}^{ij}$ are defined in terms of the transformation properties of the field(see eq. (3.94))

$$\Delta \phi^i = -\frac{1}{2} \Sigma_{\mu\nu}^{ij} \epsilon^{\mu\nu} \phi^j \quad (4.255)$$

In our case from eq. (4.32), and from eq. (4.43) in the case of an infinitesimal Lorentz transformation, we get

$$\Delta \psi(x) = \psi'(x') - \psi(x) = [S(\Lambda) - 1]\psi(x) \approx -\frac{i}{4} \sigma_{\mu\nu} \epsilon^{\mu\nu} \psi(x) \quad (4.256)$$

from which

$$\Sigma_{\mu\nu} = \frac{i}{2} \sigma_{\mu\nu} = -\frac{1}{4} [\gamma_\mu, \gamma_\nu] \quad (4.257)$$

Our result is then

$$\mathcal{M}_{\rho\nu}^\mu = i\bar{\psi}\gamma^\mu \left(x_\rho \partial_\nu - x_\nu \partial_\rho - \frac{i}{2} \sigma_{\rho\nu} \right) \psi = i\bar{\psi}\gamma^\mu \left(x_\rho \partial_\nu - x_\nu \partial_\rho + \frac{1}{4} [\gamma_\rho, \gamma_\nu] \right) \psi \quad (4.258)$$

By taking the spatial components we obtain

$$\vec{J} = (M^{23}, M^{31}, M^{12}) = \int d^3x \psi^\dagger \left(-i\vec{x} \wedge \vec{\nabla} + \frac{1}{2} \vec{\sigma} \otimes 1_2 \right) \psi \quad (4.259)$$

where 1_2 is the identity matrix in 2 dimensions, and using eq. (4.61) we have defined

$$\vec{\sigma} \otimes 1_2 = \begin{pmatrix} \vec{\sigma} & 0 \\ 0 & \vec{\sigma} \end{pmatrix} \quad (4.260)$$

The expression of \vec{J} shows the decomposition of the total angular momentum in the orbital and in the spin part. The theory has a further conserved quantity, the current $\bar{\psi}\gamma^\mu\psi$.

We will need the decomposition of the Dirac field in plane waves. To this end we will make use of the spinors $u(p, \pm n)$ e $v(p, \pm n)$ that we have defined at the end of the Section 4.3. The expansion is similar to the one used in eq. (4.126), but now $b(k)$ and $d(k)$ are operators

$$\psi(x) = \sum_{\pm n} \int \frac{d^3 p}{\sqrt{(2\pi)^3}} \sqrt{\frac{m}{E_p}} [b(p, n)u(p, n)e^{-ipx} + d^\dagger(p, n)v(p, n)e^{ipx}] \quad (4.261)$$

$$\psi^\dagger(x) = \sum_{\pm n} \int \frac{d^3 p}{\sqrt{(2\pi)^3}} \sqrt{\frac{m}{E_p}} [d(p, n)\bar{v}(p, n)e^{-ipx} + b^\dagger(p, n)\bar{u}(p, n)e^{ipx}] \gamma_0 \quad (4.262)$$

where $E_p = \sqrt{|\vec{p}|^2 + m^2}$. We will collect here the various properties of the previous spinors, which are nothing but a trivial extension of the case in which, in the rest frame, the spin is quantized along the z axis:

- Dirac equation

$$\begin{aligned} (\hat{p} - m)u(p, n) &= \bar{u}(p, n)(\hat{p} - m) = 0 \\ (\hat{p} + m)v(p, n) &= \bar{v}(p, n)(\hat{p} + m) = 0 \end{aligned} \quad (4.263)$$

- Orthogonality

$$\begin{aligned} \bar{u}(p, n)u(p, n') &= -\bar{v}(p, n)v(p, n') = \delta_{nn'} \\ u^\dagger(p, n)u(p, n') &= v^\dagger(p, n)v(p, n') = \frac{E_p}{m}\delta_{nn'} \\ \bar{v}(p, n)u(p, n') &= v^\dagger(p, n)u(\tilde{p}, n') = 0 \end{aligned} \quad (4.264)$$

where, if $p^\mu = (E_p, \vec{p})$, then $\tilde{p}^\mu = (E_p, -\vec{p})$.

- Completeness

$$\begin{aligned} \sum_{\pm n} u(p, n)\bar{u}(p, n) &= \frac{\hat{p} + m}{2m} \\ \sum_{\pm n} v(p, n)\bar{v}(p, n) &= \frac{\hat{p} - m}{2m} \end{aligned} \quad (4.265)$$

We are now in the position to express the hamiltonian in terms of the operators $b(p, n)$ e $d(p, n)$. Using eq. (4.248) we find

$$\begin{aligned}
H &= \int d^3x \sum_{\pm n, \pm n'} \int \frac{d^3 p}{\sqrt{(2\pi)^3}} \sqrt{\frac{m}{E_p}} \frac{d^3 p'}{\sqrt{(2\pi)^3}} \sqrt{\frac{m}{E_{p'}}} E_{p'} \\
&\quad \left[d(p, n) v^\dagger(p, n) e^{-ipx} + b^\dagger(p, n) u^\dagger(p, n) e^{ipx} \right] \\
&\quad \times \left[b(p', n') u(p', n') e^{-ip'x} - d^\dagger(p', n') v(p', n') e^{ip'x} \right] \\
&= \sum_{\pm n, \pm n'} \int d^3 p d^3 p' \frac{E_{p'} m}{\sqrt{E_p E_{p'}}} \\
&\quad \times \left[d(p, n) b(\tilde{p}, n') e^{-i(E_p + E_{p'})t} v^\dagger(p, n) u(\tilde{p}, n') \delta^3(\vec{p} + \vec{p}') \right. \\
&\quad + b^\dagger(p, n) b(p, n') e^{+i(E_p - E_{p'})t} u^\dagger(p, n) u(p, n') \delta^3(\vec{p} - \vec{p}') \\
&\quad - d(p, n) d^\dagger(p, n') e^{-i(E_p - E_{p'})t} v^\dagger(p, n) v(p, n') \delta^3(\vec{p} - \vec{p}') \\
&\quad \left. - b^\dagger(p, n) d(\tilde{p}, n') e^{+i(E_p + E_{p'})t} u^\dagger(p, n) v(\tilde{p}, n') \delta^3(\vec{p} + \vec{p}') \right] \quad (4.266)
\end{aligned}$$

Performing one of the integrations and using the orthogonality relations, we get

$$H = \sum_{\pm n} \int d^3 p E_p [b^\dagger(p, n) b(p, n) - d(p, n) d^\dagger(p, n)] \quad (4.267)$$

In analogous way we get

$$\vec{P} = \sum_{\pm n} \int d^3 p \vec{p} [b^\dagger(p, n) b(p, n) - d(p, n) d^\dagger(p, n)] \quad (4.268)$$

If we try to interpret these expressions as we did in the Klein-Gordon case, we would assume that the operator $d(p, n)$ creates from the vacuum a state of energy $-E_p$ and momentum $-\vec{p}$. Dirac tried to solve the problem assuming that the vacuum was filled up by the negative energy solutions. Due to the Pauli principle this would make impossible for any other negative energy state to be created. Let us called the vacuum filled up by the negative energy solutions the **Dirac vacuum**. Then the operator $d(p, n)$ should give zero when acting upon this state. We then define as the true vacuum of the theory the Dirac vacuum and require

$$d(p, n)|0\rangle_{\text{Dirac}} = 0 \quad (4.269)$$

That is, in the Dirac vacuum, the operator $d(p, n)$ behaves as an annihilation operator (thing that we have anticipated in writing). Since the Dirac vacuum is obtained by the original vacuum acting with $d(p, n)$, it follows that these operators should satisfy the following algebraic identity

$$(d(p, n))^2 = 0 \quad (4.270)$$

We can satisfy this relation in a uniform algebraic way by requiring that the operators $d(p, n)$ anticommute among themselves

$$[d(p, n), d(p', n')]_+ = 0 \quad (4.271)$$

This leads to the Jordan and Wigner idea of quantizing the Dirac field in terms of anticommutators

$$[b(p, n), b^\dagger(p', n')]_+ = [d(p, n), d^\dagger(p', n')]_+ = \delta_{nn'} \delta^3(\vec{p} - \vec{p}') \quad (4.272)$$

The problem of positivity is then solved automatically, since the four momentum operator can be written as

$$P^\mu = \sum_{\pm n} \int d^3p p^\mu \left[b^\dagger(p, n)b(p, n) + d^\dagger(p, n)d(p, n) - [d(p, n), d^\dagger(p, n)]_+ \right] \quad (4.273)$$

Due to the anticommutation relations, the last term turns out to be an infinite negative constant, which, physically, can be associated to the energy of the infinite electrons filling up the Dirac vacuum (called also the Dirac sea). If we ignore this constant (as we did in the Klein-Gordon case, and with the same warnings), the energy operator is positive definite. The use of the anticommutators solves also the problem of the wrong statistics. In fact, the wave functions are now antisymmetric in the exchange of two Dirac particles (from now on we will put $|0\rangle_{\text{Dirac}} = |0\rangle$):

$$b^\dagger(p_1, n_1)b^\dagger(p_2, n_2)|0\rangle = -b^\dagger(p_2, n_2)b^\dagger(p_1, n_1)|0\rangle \quad (4.274)$$

Therefore, the quanta of the Dirac field satisfy the Fermi-Dirac statistics. Once we have realized all that, we can safely forget about the hole theory and related stuff. In fact, looking at the four momentum operator, we can simply say that $d^\dagger(p, n)$ creates and $d(p, n)$ annihilates a positron state. then we think to the vacuum as a state with no electrons and/or positrons (that is without electrons and /or holes).

In the Klein-Gordon case we interpreted the conserved current as the electromagnetic current. We shall show now that in the Dirac case the expression $\bar{\psi}\gamma_\mu\psi$, has the same interpretation. Let us start evaluating the spatial integral of the density

$$\int d^3x \psi^\dagger\psi \quad (4.275)$$

in terms of the creation and annihilation operators

$$\int d^3x \psi^\dagger\psi = \sum_{\pm n} \int d^3p \left[b^\dagger(p, n)b(p, n) + d(p, n)d^\dagger(p, n) \right] \quad (4.276)$$

As we know, this expression is formally positive definite. However, if we couple the Dirac field to the electromagnetism through the minimal substitution we find that the free action (4.243) becomes

$$S = \int_V d^4x \bar{\psi}(i\hat{\partial} - e\hat{A} - m)\psi \quad (4.277)$$

Therefore the electromagnetic field is coupled to the conserved current

$$j^\mu = e\bar{\psi}\gamma^\mu\psi \quad (4.278)$$

This forces us to say that the integral of the fourth component of the current should be the charge operator, and as such it should not be positive definite. In fact, we find

$$\begin{aligned} Q &= e \int d^3x \psi^\dagger\psi \\ &= \sum_{\pm n} \int d^3p e \left[b^\dagger(p, n)b(p, n) - d^\dagger(p, n)d(p, n) + [d(p, n), d^\dagger(p, n)]_+ \right] \end{aligned} \quad (4.279)$$

The subtraction of the infinite charge associated to the Dirac sea leaves us with an operator which is not anymore positive definite. We see also that the operators b^\dagger create particles of charge e (electrons) whereas d^\dagger create particles of charge $-e$ (positrons). Notice that the interpretation of Q as the charge operator would not have worked by using commutation relations.

A further potential problem is connected with the causality. We have seen in the Klein-Gordon case that the causality properties is guaranteed, for the local observable, by the canonical commutation relations for the fields. But this is just the property we have given up in the Dirac case. In order to discuss this point, let us start evaluating the equal time anticommutator for the Dirac field

$$\begin{aligned} [\psi(\vec{x}, t), \psi^\dagger(\vec{y}, t)]_+ &= \sum_{\pm n, \pm n'} \int \frac{d^3p}{\sqrt{(2\pi)^3}} \sqrt{\frac{m}{E_p}} \int \frac{d^3p'}{\sqrt{(2\pi)^3}} \sqrt{\frac{m}{E_{p'}}} \delta_{nn'} \delta^3(\vec{p} - \vec{p}') \\ &\times \left[u(p, n)\bar{u}(p, n)\gamma_0 e^{i\vec{p}\cdot(\vec{x} - \vec{y})} + v(p, n)\bar{v}(p, n)\gamma_0 e^{-i\vec{p}\cdot(\vec{x} - \vec{y})} \right] \\ &= \int \frac{d^3p}{(2\pi)^3} \frac{m}{E_p} \left[\left(\frac{\hat{p} + m}{2m} \right) e^{i\vec{p}\cdot(\vec{x} - \vec{y})} + \left(\frac{\hat{p} - m}{2m} \right) e^{-i\vec{p}\cdot(\vec{x} - \vec{y})} \right] \gamma_0 \\ &= \int \frac{d^3p}{(2\pi)^3} \frac{m}{E_p} \left[\left(\frac{\hat{p} + m}{2m} \right) + \left(\frac{\hat{p} - m}{2m} \right) \right] \gamma_0 e^{i\vec{p}\cdot(\vec{x} - \vec{y})} \\ &= \int \frac{d^3p}{(2\pi)^3} \frac{m}{E_p} \frac{2E_p}{2m} e^{-i\vec{p}\cdot(\vec{x} - \vec{y})} = \delta^3(\vec{x} - \vec{y}) \end{aligned} \quad (4.280)$$

In analogous way we get

$$[\psi(\vec{x}, t), \psi(\vec{y}, t)]_+ = [\psi^\dagger(\vec{x}, t), \psi^\dagger(\vec{y}, t)]_+ = 0 \quad (4.281)$$

By using eq. (4.246). the anticommutator between ψ and ψ^\dagger can be written as

$$[\Pi_\psi(\vec{x}, t), \psi(\vec{y}, t)]_+ = i\delta^3(\vec{x} - \vec{y}) \quad (4.282)$$

This shows that also in the Dirac case one can use the canonical formalism, but with anticommutators in place of the commutators. For arbitrary space-time separations

we get

$$\begin{aligned}
& [\psi(x), \psi^\dagger(y)]_+ = \\
&= \int \frac{d^3p}{(2\pi)^3} \frac{m}{E_p} \left[\left(\frac{\hat{p} + m}{2m} \right) e^{-ip(x-y)} + \left(\frac{\hat{p} - m}{2m} \right) e^{ip(x-y)} \right] \gamma_0 \\
&= \left[(i\hat{\partial} + m)_x \gamma_0 \right] \int \frac{d^3p}{(2\pi)^3} \frac{1}{2E_p} \left[e^{-ip(x-y)} - e^{ip(x-y)} \right] \\
&= \left[(i\hat{\partial} + m)_x \gamma_0 \right] i\Delta(x-y) \tag{4.283}
\end{aligned}$$

where $\Delta(x)$ is the invariant function defined in eq. (3.148), in the evaluation of commutator for the Klein-Gordon field. From the properties of the $\Delta(x)$ function, it follows that the anticommutator of the Dirac fields vanishes at space-like distances. It follows that the Dirac field cannot be an observable quantity. In fact one could do more, by evaluating the commutator of the Dirac field. It is easy to show that the result does not vanish at space-like distances. This by itself would put in a serious trouble the idea of quantizing Dirac field via commutation relations. But how do we solve the causality problem. The crucial observation is in the following identity

$$[AB, C] = A[B, C] + [A, C]B = A[B, C]_+ - [A, C]_+ B \tag{4.284}$$

which holds for arbitrary operators. The identity shows that AB commutes with C if A and B separately commute or anticommute with C . An immediate consequence is that a local quantity containing an even number of Dirac fields commutes with itself at space-like distances. So, in order to reconcile the causality with the quantization of the Dirac field we have to give up with its property of being an observable. However, all the important physical quantities, as energy-momentum tensor and electromagnetic current are bilinear in the Fermi fields, and therefore they are observable quantities.

What we have shown here is that, in order to give a sense to the quantization of the Dirac field, we have been forced to use anticommutation relations, which, in turn, imply that the corresponding quanta obey the Fermi-Dirac statistics. This is nothing but an example of the celebrated **spin statistics theorem** that was proved by Pauli in 1940. This theorem says that in a Lorentz invariant local field theory, integer and half-integer particles must satisfy respectively Bose-Einstein and Fermi-Dirac statistics.

Chapter 5

The electromagnetic field

5.1 The quantization of the electromagnetic field

In Section 4.5 we have shown that the action for the electromagnetic field must be expressed in terms of the four-vector potential A_μ . We recall that the lagrangian density for the free case is given by (see. eq. (4.158))

$$\mathcal{L} = -\frac{1}{4}F_{\mu\nu}F^{\mu\nu} \quad (5.1)$$

where

$$F_{\mu\nu} = \partial_\mu A_\nu - \partial_\nu A_\mu \quad (5.2)$$

The resulting equations of motion are

$$\partial^2 A_\mu - \partial_\mu(\partial^\nu A_\nu) = 0 \quad (5.3)$$

We recall also that the potentials are defined up to a gauge transformation

$$A_\mu(x) \rightarrow A'_\mu(x) = A_\mu(x) + \partial_\mu\Lambda(x) \quad (5.4)$$

In fact, A_μ and A'_μ satisfy the same equations of motion (and give rise to the same electromagnetic field). In other words the action of electrodynamics is gauge invariant. Up to now, we have considered only symmetries depending on a finite number of parameters. For instance, in the case of the $O(2)$ symmetry for the charged scalar field, the transformation symmetry depends on a single parameter, the rotation angle. In the case of the gauge symmetry one deals with a continuous number of parameters, given by the function $\Lambda(x)$. In fact, in each space-time point, we can change the definition of A_μ by adding the gradient of Λ evaluated at that point. The main consequence of this type of invariance is to reduce the effective degrees of freedom of the theory from 4 to 2. Let us start from the classical theory. We recall that it is possible to use the gauge invariance to require some particular condition

on the field A_μ . For instance, we can perform a gauge transformation in such a way that the transformed field satisfies

$$\partial_\mu A^\mu = 0 \quad (5.5)$$

In fact, given an arbitrary A_μ , let us make a gauge transformation by choosing $\Lambda(x)$ such that

$$\partial^2 \Lambda + \partial^\mu A_\mu = 0 \quad (5.6)$$

Then, the transformed field $A'_\mu = A_\mu + \partial_\mu \Lambda$ has vanishing four divergence. When A_μ satisfies the condition $\partial_\mu A^\mu = 0$, we say that the potential is in the **Lorentz gauge**. Notice also that there is still a freedom in the potential. In fact by performing a further gauge transformation

$$A_\mu \rightarrow A'_\mu = A_\mu + \partial_\mu \Lambda' \quad (5.7)$$

we can stay in the Lorentz gauge, that is with $\partial^\mu A'_\mu = 0$, if

$$\partial^2 \Lambda' = 0 \quad (5.8)$$

In the Lorentz gauge the equations of motion simplify and reduce to the wave equation, or to the Klein-Gordon equation with $m = 0$. This, together the fact, that in the Lorentz gauge the covariance of the theory is explicitly preserved (the gauge condition is Lorentz invariant), makes this gauge a very popular one. However, the counting of the effective degrees of freedom is not so evident. From this point of view a better choice is the **Coulomb gauge**, which is defined as the gauge where the scalar potential and the spatial divergence of the vector potential vanish. To see that such a gauge exists, let us perform the following gauge transformation

$$A'_\mu(x) = A_\mu(x) - \partial_\mu \int_0^t A_0(\vec{x}, t') dt' \quad (5.9)$$

Clearly

$$A'_0 = 0 \quad (5.10)$$

Then we perform a second gauge transformation

$$A''_\mu = A'_\mu - \partial_\mu \Lambda \quad (5.11)$$

in such a way to have $\vec{\nabla} \cdot \vec{A}'' = 0$. To this end we choose $\Lambda(x)$ such that

$$\vec{\nabla} \cdot \vec{A}'' = \vec{\nabla} \cdot \vec{A}' + \vec{\nabla}^2 \Lambda = 0 \quad (5.12)$$

This equation can be solved by recalling that

$$\vec{\nabla}^2 \frac{1}{|\vec{x}|} = -4\pi \delta^3(\vec{x}) \quad (5.13)$$

Then

$$\Lambda(\vec{x}, t) = \frac{1}{4\pi} \int \frac{d^3x'}{|\vec{x} - \vec{x}'|} \vec{\nabla} \cdot \vec{A}'(\vec{x}', t) \quad (5.14)$$

from which

$$\frac{\partial \Lambda(\vec{x}, t)}{\partial t} = \frac{1}{4\pi} \int \frac{d^3x'}{|\vec{x} - \vec{x}'|} \vec{\nabla} \cdot \dot{\vec{A}}'(\vec{x}', t) \quad (5.15)$$

From the Gauss equation for the electric field we get

$$\vec{\nabla} \cdot \vec{E} = -\vec{\nabla}^2 A_0 - \vec{\nabla} \cdot \dot{\vec{A}} = 0 \quad (5.16)$$

and, in terms of A'_μ

$$\vec{\nabla} \cdot \vec{E} = \vec{\nabla} \cdot \dot{\vec{A}} = 0 \quad (5.17)$$

Therefore

$$\frac{\partial \Lambda(\vec{x}, t)}{\partial t} = 0 \quad (5.18)$$

from which $A''_0 = A'_0 = 0$ showing that the second gauge transformation does not destroy the vanishing of the scalar potential. In conclusion, we have shown that it is possible to choose a gauge such that

$$A_0 = \vec{\nabla} \cdot \vec{A} = 0 \quad (5.19)$$

It follows that the independent degrees of freedom are only two. Unfortunately in this gauge the explicit Lorentz covariance is lost. Another way of showing that A_μ has only two degrees of freedom is through the equations of motion. Let us consider the four dimensional Fourier transform of $A_\mu(x)$

$$A_\mu(x) = \int d^4k e^{ikx} A_\mu(k) \quad (5.20)$$

Substituting this expression in the equations of motion we get

$$-k^2 A_\mu(k) + k_\mu (k^\nu A_\nu(k)) = 0 \quad (5.21)$$

Let us now decompose $A_\mu(k)$ in terms of four independent four vectors, which can be chosen as $k^\mu = (E, \vec{k})$, $\tilde{k}^\mu = (E, -\vec{k})$, and two further four vectors $e_\mu^\lambda(k)$, $\lambda = 1, 2$, orthogonal to k^μ

$$k^\mu e_\mu^\lambda = 0, \quad \lambda = 1, 2 \quad (5.22)$$

The decomposition of $A_\mu(k)$ reads

$$A_\mu(k) = a_\lambda(k) e_\mu^\lambda + b(k) k_\mu + c(k) \tilde{k}_\mu \quad (5.23)$$

From the equations of motion we get

$$-k^2 (a_\lambda e_\mu^\lambda + b k_\mu + c \tilde{k}_\mu) + k_\mu (b k^2 + c(k \cdot \tilde{k})) = 0 \quad (5.24)$$

The term in $b(k)$ cancels, therefore it is left undetermined by the equations of motion. For the other quantities we have

$$k^2 a_\lambda(k) = c(k) = 0 \quad (5.25)$$

The arbitrariness of $b(k)$ is a consequence of the gauge invariance. In fact if we gauge transform $A_\mu(x)$

$$A_\mu(x) \rightarrow A_\mu(x) + \partial_\mu \Lambda(x) \quad (5.26)$$

then

$$A_\mu(k) \rightarrow A_\mu(k) + ik_\mu \Lambda(k) \quad (5.27)$$

where

$$\Lambda(x) = \int d^4k e^{ikx} \Lambda(k) \quad (5.28)$$

Since the gauge transformation amounts to a translation in $b(k)$ by an arbitrary function of k , we can always choose it equal to zero. Therefore we are left with the two degrees of freedom described by the amplitudes $a_\lambda(k)$, $\lambda = 1, 2$. Furthermore these amplitudes are different from zero only if the dispersion relation $k^2 = 0$ is satisfied. This shows that the corresponding quanta will have zero mass. With the choice $b(k) = 0$, the field $A_\mu(k)$ becomes

$$A_\mu(k) = a_\lambda(k) e_\mu^\lambda(k) \quad (5.29)$$

showing that $k^\mu A_\mu(k) = 0$. Therefore the choice $b(k) = 0$ is equivalent to the choice of the Lorentz gauge.

Let us consider now the quantization of this theory. If we would like to require the explicit covariance of the theory we would require non trivial commutation relations for all the component of the field. That is

$$[A_\mu(\vec{x}, t), \Pi^\nu(\vec{y}, t)] = ig_\mu^\nu \delta^3(\vec{x} - \vec{y}) \quad (5.30)$$

$$[A_\mu(\vec{x}, t), A_\nu(\vec{y}, t)] = [\Pi^\mu(\vec{x}, t), \Pi^\nu(\vec{y}, t)] = 0 \quad (5.31)$$

with

$$\Pi^\mu = \frac{\partial \mathcal{L}}{\partial \dot{A}_\mu} \quad (5.32)$$

To evaluate the conjugated momenta is better to write the lagrangian density (see eq. (5.1) in the following form

$$\mathcal{L} = -\frac{1}{4} [A_{\mu,\nu} - A_{\nu,\mu}] [A^{\mu,\nu} - A^{\nu,\mu}] = -\frac{1}{2} A_{\mu,\nu} A^{\mu,\nu} + \frac{1}{2} A_{\mu,\nu} A^{\nu,\mu} \quad (5.33)$$

Therefore

$$\frac{\partial \mathcal{L}}{\partial A_{\mu,\nu}} = -A^{\mu,\nu} + A^{\nu,\mu} = F^{\mu\nu} \quad (5.34)$$

implying

$$\Pi^\mu = \frac{\partial \mathcal{L}}{\partial \dot{A}_\mu} = F^{\mu 0} \quad (5.35)$$

It follows

$$\Pi^0 = \frac{\partial \mathcal{L}}{\partial \dot{A}_0} = 0 \quad (5.36)$$

We see that it is impossible to satisfy the condition

$$[A_0(\vec{x}, t), \Pi^0(\vec{y}, t)] = i\delta^3(\vec{x} - \vec{y}) \quad (5.37)$$

We can try to find a solution to this problem modifying the lagrangian density in such a way that $\Pi^0 \neq 0$. But doing so we will not recover the Maxwell equation. However we can take advantage of the gauge symmetry, modifying the lagrangian density in such a way to recover the equations of motion in a particular gauge. For instance, in the Lorentz gauge we have

$$\partial^2 A_\mu(x) = 0 \quad (5.38)$$

and this equation can be obtained by the lagrangian density

$$\mathcal{L} = -\frac{1}{2} A_{\mu,\nu} A^{\mu,\nu} \quad (5.39)$$

(just think to the Klein-Gordon case). We will see that the minus sign is necessary to recover a positive hamiltonian density. We now express this lagrangian density in terms of the gauge invariant one, given in eq. (5.1). To this end we observe that the difference between the two lagrangian densities is nothing but the second term of eq. (5.33)

$$\begin{aligned} \frac{1}{2} A_{\mu,\nu} A^{\nu,\mu} &= \partial^\mu \left[\frac{1}{2} A_{\mu,\nu} A^\nu \right] - \frac{1}{2} (\partial^\mu A_{\mu,\nu}) A^\nu \\ &= \partial^\mu \left[\frac{1}{2} A_{\mu,\nu} A^\nu \right] - \partial^\nu \left[\frac{1}{2} (\partial^\mu A_\mu) A_\nu \right] + \frac{1}{2} (\partial^\mu A_\mu)^2 \end{aligned} \quad (5.40)$$

Then, up to a four divergence, we can write the new lagrangian density in the form

$$\mathcal{L} = -\frac{1}{4} F_{\mu\nu} F^{\mu\nu} - \frac{1}{2} (\partial^\mu A_\mu)^2 \quad (5.41)$$

One can check that this form gives the correct equations of motion. In fact from

$$\frac{\partial \mathcal{L}}{\partial A_{\mu,\nu}} = -A^{\mu,\nu} + A^{\nu,\mu} - g^{\mu\nu} (\partial^\lambda A_\lambda), \quad \frac{\partial \mathcal{L}}{\partial A_\mu} = 0 \quad (5.42)$$

we get

$$0 = -\partial^2 A^\mu + \partial^\mu (\partial^\nu A_\nu) - \partial^\mu (\partial^\lambda A_\lambda) = -\partial^2 A^\mu \quad (5.43)$$

the term

$$-\frac{1}{2}(\partial^\mu A_\mu)^2 \quad (5.44)$$

which is not gauge invariant, is called the **gauge fixing term**. More generally, we could add to the original lagrangian density a term of the form

$$-\frac{\lambda}{2}(\partial^\mu A_\mu)^2 \quad (5.45)$$

The corresponding equations of motion turn out to be

$$\partial^2 A_\mu - (1 - \lambda)\partial^\mu(\partial^\lambda A_\lambda) = 0 \quad (5.46)$$

These equations are the same as the Maxwell equations in the Lorentz gauge. Therefore, in the following we will use $\lambda = 1$. From eq. (5.42) we see that

$$\Pi^0 = \frac{\partial \mathcal{L}}{\partial \dot{A}_0} = -\partial^\mu A_\mu \quad (5.47)$$

In the Lorentz gauge we find again $\Pi^0 = 0$. To avoid the corresponding problem we can ask that $\partial^\mu A_\mu = 0$ does not hold as an operator condition, but rather as a condition upon the physical states

$$\langle \text{phys} | \partial^\mu A_\mu | \text{phys} \rangle = 0 \quad (5.48)$$

The price to pay to quantize the theory in a covariant way is to work in a Hilbert space much bigger than the physical one. The physical states span a subspace which is defined by the previous relation. A further bonus is that in this way one has to do with local commutation relations. On the contrary, in the Coulomb gauge, one needs to introduce non local commutation relations for the canonical variables. We will come back later to the condition (5.48).

Since we don't have to worry any more about the operator condition $\Pi^0 = 0$, we can proceed with our program of canonical quantization. The canonical momentum densities are

$$\Pi^\mu = \frac{\partial \mathcal{L}}{\partial \dot{A}_\mu} = F^{\mu 0} - g^{\mu 0}(\partial^\lambda A_\lambda) \quad (5.49)$$

or, explicitly

$$\begin{aligned} \Pi^0 &= -\partial^\lambda A_\lambda = -\dot{A}_0 - \vec{\nabla} \cdot \vec{A} \\ \Pi^i &= \partial^i A_0 - \partial^0 A^i = -\dot{A}^i + \partial^i A^0 \end{aligned} \quad (5.50)$$

Since the spatial gradient of the field commutes with the field itself at equal time, the canonical commutator (5.30) gives rise to

$$[A_\mu(\vec{x}, t), \dot{A}_\nu(\vec{y}, t)] = -i g_{\mu\nu} \delta^3(\vec{x} - \vec{y}) \quad (5.51)$$

To get the quanta of the field we look for plane wave solutions of the wave equation. We need four independent four vectors in order to expand the solutions in the momentum space. In a given frame, let us consider the unit four vector which defines the time axis. This must be a time-like vector, $n^2 = 1$, and we will choose $n^0 > 0$. For instance, $n^\mu = (1, 0, 0, 0)$. Then we take two four vectors $\epsilon_\mu^{(\lambda)}$, $\lambda = 1, 2$, in the plane orthogonal to n^μ and k^μ . Notice that now $k^2 = 0$, since we are considering solutions of the wave equation. Therefore

$$k^\mu \epsilon_\mu^{(\lambda)} = n^\mu \epsilon_\mu^{(\lambda)} = 0, \quad \lambda = 1, 2 \quad (5.52)$$

The four vectors $\epsilon_\mu^{(\lambda)}$, being orthogonal to n^μ are space-like, then they will be chosen orthogonal and normalized in the following way

$$\epsilon_\mu^{(\lambda)} \epsilon^{(\lambda')\mu} = -\delta_{\lambda\lambda'} \quad (5.53)$$

Next, we define a unit space-like four vector, orthogonal to n^μ and lying in the plane (k, n)

$$n^\mu \epsilon_\mu^{(3)} = 0 \quad (5.54)$$

with

$$\epsilon_\mu^{(3)} \epsilon^{(3)\mu} = -1 \quad (5.55)$$

By construction $\epsilon_\mu^{(3)}$ is orthogonal to $\epsilon_\mu^{(\lambda)}$. This four vector is completely fixed by the previous conditions, and we get

$$\epsilon_\mu^{(3)} = \frac{k_\mu - (n \cdot k) n_\mu}{(n \cdot k)} \quad (5.56)$$

A last unit four vector we choose n^μ

$$\epsilon_\mu^{(0)} = n_\mu \quad (5.57)$$

These four vector are orthonormal and we can write

$$\epsilon_\mu^{(\lambda)} \epsilon^{(\lambda')\mu} = g^{\lambda\lambda'} \quad (5.58)$$

and being linearly independent, they satisfy the completeness relation

$$\epsilon_\mu^{(\lambda)} \epsilon_\nu^{(\lambda')} g_{\lambda\lambda'} = g_{\mu\nu} \quad (5.59)$$

In the frame where $n^\mu = (1, \vec{0})$ and $k^\mu = (k, 0, 0, k)$, we have

$$\epsilon^{(1)\mu} = (0, 1, 0, 0), \quad \epsilon^{(2)\mu} = (0, 0, 1, 0), \quad \epsilon^{(3)\mu} = (0, 0, 0, 1) \quad (5.60)$$

The plane wave expansion of A_μ is

$$A_\mu(x) = \int \frac{d^3k}{\sqrt{2\omega_k}(2\pi)^3} \sum_{\lambda=0}^3 \epsilon_\mu^{(\lambda)}(k) \left[a_\lambda(k) e^{-ikx} + a_\lambda^\dagger(k) e^{ikx} \right] \quad (5.61)$$

where we have included the hermiticity condition for $A_\mu(x)$. For any fixed μ , this expansion is the same as the one that we wrote for the Klein-Gordon field, with the substitution $\epsilon_\mu^{(\lambda)} a_\lambda(k) \rightarrow a(k)$. Then, from eq. (3.60)

$$\epsilon_\mu^{(\lambda)}(k) a_\lambda(k) = i \int d^3x f_{\vec{k}}^*(x) \partial_t^{(-)} A_\mu(x) \quad (5.62)$$

with the functions $f_{\vec{k}}(x)$ defined as in Section 3.2. Using the orthogonality of the $\epsilon^{(\lambda')\mu}$'s we find

$$a_\lambda(k) = i g_{\lambda\lambda'} \int d^3x \epsilon^{(\lambda')\mu}(k) f_{\vec{k}}^*(x) \partial_t^{(-)} A_\mu(x) \quad (5.63)$$

and analogously

$$a_\lambda^\dagger(k) = i g_{\lambda\lambda'} \int d^3x \epsilon^{(\lambda')\mu}(k) A_\mu(x) \partial_t^{(-)} f_{\vec{k}}(x) \quad (5.64)$$

Comparison with the calculation done in eq. (2.91) we get

$$\begin{aligned} & [a_\lambda(k), a_{\lambda'}^\dagger(k')] = \\ &= \int d^3x d^3y \left[-f_{\vec{k}}^*(x) \dot{f}_{\vec{k}'}(y) \left(i g_{\mu\nu} g_{\lambda\lambda'} \epsilon^{(\lambda'')\mu}(k) \epsilon^{(\lambda''')\nu}(k') g_{\lambda'\lambda'''} \delta^3(\vec{x} - \vec{y}) \right) \right. \\ & \quad \left. - \dot{f}_{\vec{k}}^*(x) f_{\vec{k}'}(y) \left(-i g_{\mu\nu} g_{\lambda\lambda'} \epsilon^{(\lambda'')\mu}(k) \epsilon^{(\lambda''')\nu}(k') g_{\lambda'\lambda'''} \delta^3(\vec{x} - \vec{y}) \right) \right] \\ &= - \int d^3x f_{\vec{k}}^*(x) i \partial_t^{(-)} f_{\vec{k}'}(x) g_{\lambda\lambda'} \end{aligned} \quad (5.65)$$

and using the orthogonality relations of eq. (3.50)

$$[a_\lambda(k), a_{\lambda'}^\dagger(k')] = -g_{\lambda\lambda'} \delta^3(\vec{k} - \vec{k}') \quad (5.66)$$

Analogously

$$[a_\lambda(k), a_{\lambda'}(k')] = [a_\lambda^\dagger(k), a_{\lambda'}^\dagger(k')] = 0 \quad (5.67)$$

Again from the comparison of the Klein-Gordon commutators we have

$$[A_\mu(x), A_\nu(y)] = -i g_{\mu\nu} \Delta(x - y) \quad (5.68)$$

with the invariant function $\Delta(x)$ defined as in eq. (3.148), but with $m = 0$. The commutation rules we have derived for the operators $a_\lambda(k)$ create some problem. Let us consider a one-particle state

$$|1, \lambda\rangle = \int d^3k f(k) a_\lambda^\dagger(k) |0\rangle \quad (5.69)$$

its norm is given by

$$\begin{aligned} \langle 1, \lambda | 1, \lambda \rangle &= \int d^3k d^3k' f^*(k) f(k') \langle 0 | a_\lambda(k) a_\lambda^\dagger(k') | 0 \rangle \\ &= \int d^3k d^3k' f^*(k) f(k') \langle 0 | [a_\lambda(k), a_\lambda^\dagger(k')] | 0 \rangle \\ &= -g_{\lambda\lambda} \int d^3k |f(k)|^2 \end{aligned} \quad (5.70)$$

Therefore the states with $\lambda = 0$ have negative norm. This problem does not come out completely unexpected. In fact, our expectation is that only the transverse states ($\lambda = 1, 2$), are physical states. For the moment being we have ignored the gauge fixing condition $\langle \text{phys} | \partial^\mu A_\mu | \text{phys} \rangle = 0$, but its meaning is that only part of the total Hilbert space is physical. Therefore the relevant thing is to show that the states satisfying the Lorentz condition have positive norm. To discuss the gauge fixing condition, let us notice that formulated in the way we did, being bilinear in the states, it could destroy the linearity of the Hilbert space. So we will try to modify the condition in a linear one

$$\partial^\mu A_\mu | \text{phys.} \rangle = 0 \quad (5.71)$$

But this would be a too strong requirement. Not even the vacuum state satisfies it. However, if we consider the positive and negative frequency parts of the field

$$A_\mu^{(+)}(x) = \int \frac{d^3k}{\sqrt{2\omega_k(2\pi)^3}} \sum_{\lambda=0}^3 \epsilon_\mu^{(\lambda)}(k) a_\lambda(k) e^{-ikx}, \quad A_\mu^{(-)}(x) = (A_\mu^{(+)}(x))^\dagger \quad (5.72)$$

it is possible to weaken the condition, and require

$$\partial^\mu A_\mu^{(+)}(x) | \text{phys.} \rangle = 0 \quad (5.73)$$

This allows us to satisfy automatically the original requirement

$$\langle \text{phys.} | (\partial^\mu A_\mu^{(+)} + \partial^\mu A_\mu^{(-)}) | \text{phys.} \rangle = 0 \quad (5.74)$$

To make this condition more explicit let us evaluate the four divergence of $A_\mu^{(+)}$

$$i\partial^\mu A_\mu^{(+)}(x) = \int \frac{d^3k}{\sqrt{2\omega_k(2\pi)^3}} e^{-ikx} \sum_{\lambda=0,3} k^\mu \epsilon_\mu^{(\lambda)}(k) a_\lambda(k) \quad (5.75)$$

Using eq. (5.56), we get

$$k^\mu \epsilon_\mu^{(3)} = -(n \cdot k), \quad k^\mu \epsilon_\mu^{(0)} = (n \cdot k) \quad (5.76)$$

from which

$$[a_0(k) - a_3(k)] | \text{phys.} \rangle = 0 \quad (5.77)$$

Notice that

$$[a_0(k) - a_3(k), a_0^\dagger(k') - a_3^\dagger(k')] = -\delta^3(\vec{k} - \vec{k}') + \delta^3(\vec{k} - \vec{k}') = 0 \quad (5.78)$$

Let us denote by $\Phi_{\vec{k}}(n_0, n_3)$ the state with n_0 scalar photons (that is with polarization $\epsilon_\mu^{(0)}(k)$), and with n_3 longitudinal photons (that is with polarization $\epsilon_\mu^{(3)}(k)$). Then the following states satisfy the condition (5.73)

$$\Phi_{\vec{k}}^{(m)} = \frac{1}{m!} (a_0^\dagger(k) - a_3^\dagger(k))^m \Phi_{\vec{k}}(0, 0) \quad (5.79)$$

These states have vanishing norm

$$||\Phi_{\vec{k}}^{(m)}||^2 = 0 \quad (5.80)$$

More generally we can make the following observation. Let us consider the number operator for scalar and longitudinal photons

$$N = \int d^3k (a_3^\dagger(k)a_3(k) - a_0^\dagger(k)a_0(k)) \quad (5.81)$$

Notice the minus sign that is a consequence of the commutation relations, and it ensures that N has positive eigenvalues. For instance

$$Na_0^\dagger(k)|0\rangle = - \int d^3k' a_0^\dagger(k')[a_0(k'), a_0^\dagger(k)]|0\rangle = a_0^\dagger(k)|0\rangle \quad (5.82)$$

Let us consider a physical state with a total number n of scalar and longitudinal photons. Then

$$\langle\varphi_n|N|\varphi_n\rangle = 0 \quad (5.83)$$

since a_0 and a_3 act in the same way on a physical state (see eq. (5.77)). It follows

$$n\langle\varphi_n|\varphi_n\rangle = 0 \quad (5.84)$$

Therefore all the physical states with a total definite number of scalar and longitudinal photons have zero norm, except for the vacuum state ($n = 0$). Then

$$\langle\varphi_n|\varphi_n\rangle = \delta_{n,0} \quad (5.85)$$

A generic physical state with zero transverse photons is a linear superposition of the previous states

$$|\varphi\rangle = c_0|\varphi_0\rangle + \sum_{i \neq 0} c_i|\varphi_i\rangle \quad (5.86)$$

This state has a positive definite norm

$$\langle\varphi|\varphi\rangle = |c_0|^2 \geq 0 \quad (5.87)$$

The proof that a physical state has a positive norm can be extended to the case in which also transverse photons are present. Of course, the coefficients c_i , appearing in the expression of a physical state, are completely arbitrary, but this is not going to modify the values of the observables. For instance, consider the hamiltonian, we have

$$\begin{aligned} H &= \int d^3x : [\Pi^\mu \dot{A}_\mu - \mathcal{L}] : \\ &= \int d^3x : \left[F^{\mu 0} \dot{A}_\mu - (\partial^\lambda A_\lambda) \dot{A}_0 + \frac{1}{4} F_{\mu\nu} F^{\mu\nu} + \frac{1}{2} (\partial^\lambda A_\lambda)^2 \right] : \end{aligned} \quad (5.88)$$

One can easily show the hamiltonian is given by the sum of all the degrees of freedom appearing in A_μ (see the Klein-Gordon case, eq. (3.102))

$$\begin{aligned} H &= \frac{1}{2} \int d^3x : \left[\sum_{i=1}^3 (\dot{A}_i^2 + (\vec{\nabla} A_i)^2) - \dot{A}_0^2 - \vec{\nabla} A_0^2 \right] : \\ &= \int d^3k \omega_k : \left[\sum_{\lambda=1}^3 a_\lambda^\dagger(k) a_\lambda(k) - a_0^\dagger(k) a_0(k) \right] : \end{aligned} \quad (5.89)$$

Since on the physical states a_0 and a_3 act in the same way, we get

$$\langle \text{phys.} | H | \text{phys.} \rangle = \langle \text{phys.} | \int d^3k \omega_k \sum_{\lambda=1}^2 a_\lambda^\dagger(k) a_\lambda(k) | \text{phys.} \rangle \quad (5.90)$$

The generic physical state is of the form $|\varphi_T\rangle \otimes |\varphi\rangle$. with $|\varphi\rangle$ defined as in eq. (5.86). Since only $|\varphi_T\rangle$, contributes to the evaluation of an observable quantity, we can always choose $|\varphi\rangle$ proportional to $|\varphi_0\rangle$. However, this does not mean that we are always working in the restricted physical space, because in a sum over the intermediate states we need to include all the degrees of freedom. This is crucial for the explicit covariance and locality of the theory.

The arbitrariness in defining the state $|\varphi\rangle$ has, in fact, a very simple interpretation. It corresponds to add to A_μ a four gradient, that is it corresponds to perform a gauge transformation. Consider the following matrix element

$$\langle \varphi | A_\mu(x) | \varphi \rangle = \sum_{n,m} c_n^* c_m \langle \varphi_n | A_\mu(x) | \varphi_m \rangle \quad (5.91)$$

Since A_μ change the occupation number by one unit and all the states $|\varphi_n\rangle$ have zero norm (except for the state with $n = 0$), the only non vanishing contributions come from $n = 0, m = 1$ and $n = 1, m = 0$

$$\langle \varphi | A_\mu(x) | \varphi \rangle = c_0^* c_1 \langle 0 | \int \frac{d^3k}{\sqrt{2\omega_k(2\pi)^3}} e^{-ikx} [\epsilon_\mu^{(3)}(k) a_3(k) + \epsilon_\mu^{(0)}(k) a_0(k)] | \varphi_1 \rangle + \text{c.c.} \quad (5.92)$$

In order to satisfy the gauge condition the state $|\varphi_1\rangle$ is of the form

$$|\varphi_1\rangle = \int d^3q f(\vec{q}) [a_3^\dagger(q) - a_0^\dagger(q)] | 0 \rangle \quad (5.93)$$

and therefore

$$\langle \varphi | A_\mu(x) | \varphi \rangle = \int \frac{d^3k}{\sqrt{2\omega_k(2\pi)^3}} [\epsilon_\mu^{(3)}(k) + \epsilon_\mu^{(0)}(k)] [c_0^* c_1 e^{-ikx} f(\vec{k}) + \text{c.c.}] \quad (5.94)$$

From eqs. (5.56) and (5.57) we have

$$\epsilon_\mu^{(3)} + \epsilon_\mu^{(0)} = \frac{k_\mu}{(k \cdot n)} \quad (5.95)$$

from which

$$\langle \varphi | A_\mu(x) | \varphi \rangle = \partial_\mu \Lambda(x) \quad (5.96)$$

with

$$\Lambda(x) = \int \frac{d^3k}{\sqrt{2\omega_k}(2\pi)^3} \frac{1}{n \cdot k} (ic_0^* c_1 e^{-ikx} f(\vec{k}) + \text{c.c.}) \quad (5.97)$$

It is important to notice that this gauge transformation leaves A_μ in the Lorentz gauge, since

$$\partial^2 \Lambda = 0 \quad (5.98)$$

because the momentum k inside the integral satisfies $k^2 = 0$.

Chapter 6

Symmetries in field theories

6.1 The linear σ -model

In this Section and in the following we will study, from a classical point of view, some field theory with particular symmetry properties. We will start examining the linear σ -model. This is a model for N scalar fields, with a symmetry $O(N)$. The lagrangian is given by

$$\mathcal{L} = \frac{1}{2} \sum_{i=1}^N \partial_\mu \phi_i \partial^\mu \phi_i - \frac{1}{2} \mu^2 \sum_{i=1}^N \phi_i \phi_i - \frac{\lambda}{4} \left(\sum_{i=1}^N \phi_i \phi_i \right)^2 \quad (6.1)$$

This lagrangian is invariant under linear transformations acting upon the vector $\vec{\phi} = (\phi_1, \dots, \phi_N)$ and leaving invariant its norm

$$|\vec{\phi}|^2 = \sum_{i=1}^N \phi_i \phi_i \quad (6.2)$$

Consider an infinitesimal transformation (from now on we will omit the index of sum over the indices which are repeated)

$$\delta \phi_i = \epsilon_{ij} \phi_j \quad (6.3)$$

The condition for letting the norm invariant gives

$$|\vec{\phi} + \delta \vec{\phi}|^2 = |\vec{\phi}|^2 \quad (6.4)$$

from which

$$\vec{\phi} \cdot \delta \vec{\phi} = 0 \quad (6.5)$$

or, in components,

$$\phi_i \epsilon_{ij} \phi_j = 0 \quad (6.6)$$

This is satisfied by

$$\epsilon_{ij} = -\epsilon_{ji} \quad (6.7)$$

showing that the rotations in N dimensions depend on $N(N-1)/2$ parameters. For a finite transformation we have

$$|\vec{\phi}'|^2 = |\vec{\phi}|^2 \quad (6.8)$$

with

$$\phi'_i = S_{ij}\phi_j \quad (6.9)$$

implying

$$SS^T = 1 \quad (6.10)$$

In fact, by exponentiating the infinitesimal transformation one gets

$$S = e^\epsilon \quad (6.11)$$

with

$$\epsilon^T = -\epsilon \quad (6.12)$$

implying that S is an orthogonal transformation. The matrices S form the rotation group in N dimensions, $O(N)$.

The Noether's theorem implies a conserved current for any symmetry of the theory. In this case we will get $N(N-1)/2$ conserved quantities. It is useful for further generalizations to write the infinitesimal transformation in the form

$$\delta\phi_i = \epsilon_{ij}\phi_j = -\frac{i}{2}\epsilon_{AB}T_{ij}^{AB}\phi_j, \quad i, j = 1, \dots, N, \quad A, B = 1, \dots, N \quad (6.13)$$

which is similar to what we did in Section 3.3 when we discussed the Lorentz transformations. By comparison we see that the matrices T^{AB} are given by

$$T_{ij}^{AB} = i(\delta_i^A\delta_j^B - \delta_j^A\delta_i^B) \quad (6.14)$$

It is not difficult to show that these matrices satisfy the algebra

$$[T^{AB}, T^{CD}] = -i\delta^{AC}T^{BD} + i\delta^{AD}T^{BC} - i\delta^{BD}T^{AC} + i\delta^{BC}T^{AD} \quad (6.15)$$

This is nothing but the Lie algebra of the group $O(N)$, and the T^{AB} are the infinitesimal generators of the group. Applying now the Noether's theorem we find the conserved current

$$j_\mu = \frac{\partial\mathcal{L}}{\partial(\partial^\mu\phi_i)}\delta\phi_i = -\frac{i}{2}\phi_{i,\mu}\epsilon_{AB}T_{ij}^{AB}\phi_j \quad (6.16)$$

since the $N(N-1)/2$ parameters ϵ_{AB} are linearly independent, we find the $N(N-1)/2$ conserved currents

$$J_\mu^{AB} = -i\phi_{i,\mu}T_{ij}^{AB}\phi_j \quad (6.17)$$

In the case of $N=2$ the symmetry is the same that we have studied in Section 3.6, and the only conserved current is given by

$$J_\mu^{12} = -J_\mu^{21} = \phi_{1,\mu}\phi_2 - \phi_{2,\mu}\phi_1 \quad (6.18)$$

in agreement with (3.169). One can easily check that the charges associated to the conserved currents close the same Lie algebra as the generators T^{AB} . More generally, if we have conserved currents given by

$$j_\mu^A = -i\phi_{i,\mu}T_{ij}^A\phi_j \quad (6.19)$$

with

$$[T^A, T^B] = if^{ABC}T^C \quad (6.20)$$

then, using the canonical commutation relations, we get

$$[Q^A, Q^B] = if^{ABC}Q^C \quad (6.21)$$

with

$$Q^A = \int d^3x j_0^A(x) = -i \int d^3x \dot{\phi}_i T_{ij}^A \phi_j \quad (6.22)$$

A particular example is the case $N = 4$. We parameterize our fields in the form

$$\vec{\phi} = (\pi_1, \pi_2, \pi_3, \sigma) = (\vec{\pi}, \sigma) \quad (6.23)$$

These fields can be arranged into a 2×2 matrix

$$M = \sigma + i\vec{\tau} \cdot \vec{\pi} \quad (6.24)$$

where $\vec{\tau}$ are the Pauli matrices. Noticing that τ_2 is pure imaginary, τ_1 and τ_3 real, and that τ_2 anticommutes with τ_1 and τ_3 , we get

$$M = \tau_2 M^* \tau_2 \quad (6.25)$$

Furthermore we have the relation

$$|\vec{\phi}|^2 = \sigma^2 + |\vec{\pi}|^2 = \frac{1}{2}Tr(M^\dagger M) \quad (6.26)$$

Using this it is easy to write the lagrangian for the σ -model in the form

$$\mathcal{L} = \frac{1}{4}Tr(\partial_\mu M^\dagger \partial^\mu M) - \frac{1}{4}\mu^2 Tr(M^\dagger M) - \frac{1}{16}\lambda (Tr(M^\dagger M))^2 \quad (6.27)$$

This lagrangian is invariant under the following transformation of the matrix M

$$M \rightarrow LMR^\dagger \quad (6.28)$$

where L and R are two special (that is with determinant equal to 1) unitary matrices, that is $L, R \in SU(2)$. The reason to restrict these matrices to be special is that only in this way the transformed matrix satisfy the condition (6.25). In fact, if A is a 2×2 matrix with $det A = 1$, then

$$\tau_2 A^T \tau_2 = A^{-1} \quad (6.29)$$

Therefore, for $M' = LMR^\dagger$ we get

$$\tau_2 M'^* \tau_2 = \tau_2 L^* M^* R^T \tau_2 = \tau_2 L^* \tau_2 (\tau_2 M^* \tau_2) \tau_2 R^T \tau_2 \quad (6.30)$$

and from (6.29)

$$\begin{aligned} \tau_2 L^* \tau_2 &= \tau_2 L^{\dagger T} \tau_2 = L^{\dagger -1} = L \\ \tau_2 R^T \tau_2 &= R^{-1} = R^\dagger \end{aligned} \quad (6.31)$$

since the L and R are independent transformations, the invariance group in this basis is $SU(2)_L \otimes SU(2)_R$. In fact this group and $O(4)$ are related by the following observation: the transformation $M \rightarrow LMR^\dagger$ is a linear transformation on the matrix elements of M , but from the relation (6.26) we see that $M \rightarrow LMR^\dagger$ leaves the norm of the vector $\vec{\phi} = (\vec{\pi}, \sigma)$ invariant and therefore the same must be true for the linear transformation acting upon the matrix elements of M , that is on σ and $\vec{\pi}$. Therefore this transformation must belong to $O(4)$. This shows that the two groups $SU(2) \otimes SU(2)$ and $O(4)$ are homomorphic (actually there is a 2 to 1 relationship, since $-L$ and $-R$ define the same S as L and R).

We can evaluate the effect of an infinitesimal transformation. To this end we will consider separately left and right transformations. We parameterize the transformations as follows

$$L \approx 1 - \frac{i}{2} \vec{\theta}_L \cdot \vec{\tau}, \quad R \approx 1 - \frac{i}{2} \vec{\theta}_R \cdot \vec{\tau} \quad (6.32)$$

then we get

$$\delta_L M = \left(-\frac{i}{2} \vec{\theta}_L \cdot \vec{\tau}\right) M = \left(-\frac{i}{2} \vec{\theta}_L \cdot \vec{\tau}\right) (\sigma + i\vec{\pi} \cdot \vec{\pi}) = \frac{1}{2} \vec{\theta}_L \cdot \vec{\pi} + \frac{i}{2} (\vec{\theta}_L \wedge \vec{\pi} - \vec{\theta}_L \sigma) \cdot \vec{\tau} \quad (6.33)$$

where we have used

$$\tau_i \tau_j = \delta_{ij} + i\epsilon_{ijk} \tau_k \quad (6.34)$$

Since

$$\delta_L M = \delta_L \sigma + i\delta_L \vec{\pi} \cdot \vec{\tau} \quad (6.35)$$

we get

$$\delta_L \sigma = \frac{1}{2} \vec{\theta}_L \cdot \vec{\pi}, \quad \delta_L \vec{\pi} = \frac{1}{2} (\vec{\theta}_L \wedge \vec{\pi} - \vec{\theta}_L \sigma) \quad (6.36)$$

Analogously we obtain

$$\delta_R \sigma = -\frac{1}{2} \vec{\theta}_R \cdot \vec{\pi}, \quad \delta_R \vec{\pi} = \frac{1}{2} (\vec{\theta}_R \wedge \vec{\pi} + \vec{\theta}_R \sigma) \quad (6.37)$$

The combined transformation is given by

$$\delta \sigma = \frac{1}{2} (\vec{\theta}_L - \vec{\theta}_R) \cdot \vec{\pi}, \quad \delta \vec{\pi} = \frac{1}{2} [(\vec{\theta}_L + \vec{\theta}_R) \wedge \vec{\pi} - (\vec{\theta}_L - \vec{\theta}_R) \sigma] \quad (6.38)$$

and we can check immediately that

$$\sigma\delta\sigma + \vec{\pi} \cdot \delta\vec{\pi} = 0 \quad (6.39)$$

as it must be for a transformation leaving the form $\sigma^2 + |\vec{\pi}|^2$ invariant. Of particular interest are the transformations with $\vec{\theta}_L = \vec{\theta}_R \equiv \theta$. In this case we have $L = R$ and

$$M \rightarrow LML^\dagger \quad (6.40)$$

These transformations span a subgroup $SU(2)$ of $SU(2)_L \otimes SU(2)_R$ called the diagonal subgroup. In this case we have

$$\delta\sigma = 0, \quad \delta\vec{\pi} = \vec{\theta} \wedge \vec{\pi} \quad (6.41)$$

We see that the transformations corresponding to the diagonal $SU(2)$ are the rotations in the 3-dimensional space spanned by $\vec{\pi}$. These rotations define a subgroup $O(3)$ of the original symmetry group $O(4)$. From the Noether's theorem we get the conserved currents

$$j_\mu^L = \frac{1}{2}\sigma_{,\mu}\vec{\theta}_L \cdot \vec{\pi} + \frac{1}{2}\vec{\pi}_{,\mu} \cdot (\vec{\theta}_L \wedge \vec{\pi} - \vec{\theta}_L\sigma) \quad (6.42)$$

and dividing by $\theta_L/2$

$$\vec{J}_\mu^L = \sigma_{,\mu}\vec{\pi} - \vec{\pi}_{,\mu}\sigma - \vec{\pi}_{,\mu} \wedge \vec{\pi} \quad (6.43)$$

and analogously

$$\vec{J}_\mu^R = -\sigma_{,\mu}\vec{\pi} + \vec{\pi}_{,\mu}\sigma - \vec{\pi}_{,\mu} \wedge \vec{\pi} \quad (6.44)$$

Using the canonical commutation relations one can verify that the corresponding charges satisfy the Lie algebra of $SU(2)_L \otimes SU(2)_R$

$$[Q_i^L, Q_j^L] = i\epsilon_{ijk}Q_k^L, \quad [Q_i^R, Q_j^R] = i\epsilon_{ijk}Q_k^R, \quad [Q_i^L, Q_j^R] = 0 \quad (6.45)$$

By taking the following combinations of the currents

$$\vec{J}_\mu^V = \frac{1}{2}(\vec{J}_\mu^L + \vec{J}_\mu^R), \quad \vec{J}_\mu^A = \frac{1}{2}(\vec{J}_\mu^L - \vec{J}_\mu^R) \quad (6.46)$$

one has

$$\vec{J}_\mu^V = \vec{\pi} \wedge \vec{\pi}_{,\mu} \quad (6.47)$$

and

$$\vec{J}_\mu^A = \sigma_{,\mu}\vec{\pi} - \vec{\pi}_{,\mu}\sigma \quad (6.48)$$

The corresponding algebra of charges is

$$[Q_i^V, Q_j^V] = i\epsilon_{ijk}Q_k^V, \quad [Q_i^V, Q_j^A] = i\epsilon_{ijk}Q_k^A, \quad [Q_i^A, Q_j^A] = i\epsilon_{ijk}Q_k^V \quad (6.49)$$

These equations show that Q_i^V are the infinitesimal generators of a subgroup $SU(2)$ of $SU(2)_L \otimes SU(2)_R$ which is the diagonal subgroup, as it follows from

$$[Q_i^V, \pi_j] = i\epsilon_{ijk}\pi_k, \quad [Q_i^V, \sigma] = 0 \quad (6.50)$$

In the following we will be interested in treating the interacting field theories by using the perturbation theory. As in the quantum mechanical case, this is well defined only when we are considering the theory close to a minimum the energy of the system. In fact if we are going to expand around a maximum the oscillation of the system can become very large leading us outside of the domain of perturbation theory. In the case of the linear σ -model the energy is given by

$$H = \int d^3x \mathcal{H} = \int d^3x \left[\sum_{i=1}^N \frac{\partial \mathcal{L}}{\partial \dot{\phi}_i} \dot{\phi}_i - \mathcal{L} \right] = \int d^3x \left[\frac{1}{2} \sum_{i=1}^N (\dot{\phi}_i^2 + |\vec{\nabla} \phi_i|^2) + V(|\vec{\phi}|^2) \right] \quad (6.51)$$

Since in the last member of this relation the first two terms are positive definite, it follows that the absolute minimum is obtained for constant field configurations, such that

$$\frac{\partial V(|\vec{\phi}|^2)}{\partial \phi_i} = 0 \quad (6.52)$$

Let us call by v_i the generic solution to this equation (in general it could happen that the absolute minimum is degenerate). Then the condition for getting a minimum is that the eigenvalues of the matrix of the second derivatives of the potential at the stationary point are definite positive. In this case we define new fields by shifting the original fields by

$$\phi_i \rightarrow \phi'_i = \phi_i - v_i \quad (6.53)$$

The lagrangian density becomes

$$\mathcal{L} = \frac{1}{2} \partial_\mu \phi'_i \partial^\mu \phi'_i - V(|\vec{\phi}' + \vec{v}|^2) \quad (6.54)$$

Expanding V in series of ϕ'_i we get

$$V = V(|\vec{v}|^2) + \frac{1}{2} \frac{\partial^2 V}{\partial \phi_i \partial \phi_j} \Big|_{\vec{\phi}=\vec{v}} \phi'_i \phi'_j + \dots \quad (6.55)$$

This equation shows that the particle masses are given by the eigenvalues of the second derivative of the potential at the minimum. In the case of the linear σ -model we have

$$V = \frac{1}{2} \mu^2 |\vec{\phi}|^2 + \frac{\lambda}{4} (|\vec{\phi}|^2)^2 \quad (6.56)$$

Therefore

$$\frac{\partial V}{\partial \phi_i} = \mu^2 \phi_i + \lambda \phi_i |\vec{\phi}|^2 \quad (6.57)$$

In order to have a solution to the stationary condition we must have $\phi_i = 0$, or

$$|\vec{\phi}|^2 = -\frac{\mu^2}{\lambda} \quad (6.58)$$

This equation has real solutions only if $\mu^2/\lambda < 0$. However, in order to have a potential bounded from below one has to require $\lambda > 0$, therefore we may have non

zero solutions to the minimum condition only if $\mu^2 < 0$. But, notice that in this case, μ^2 cannot be identified with a physical mass, these are given by the eigenvalues of the matrix of the second derivatives of the potential at the minimum and they are positive definite by definition. We will study this case in the following Sections. In the case of $\mu^2 > 0$ the minimum is given by $\phi_i = 0$ and one can study the theory by taking the term $\lambda(|\vec{\phi}|^2)^2$ as a small perturbation (that is requiring that both λ and the values of ϕ_i , the fluctuations, are small). The free theory is given by the quadratic terms in the lagrangian density, and they describe N particles of common mass m . Furthermore, both the free and the interacting theories are $O(N)$ symmetric.

6.2 Spontaneous symmetry breaking

In this Section we will see that the linear σ -model with $\mu^2 < 0$, is just but an example of a general phenomenon which goes under the name of spontaneous symmetry breaking of symmetry. This phenomenon lies at the basis of the modern description of phase transitions and it has acquired a capital relevance in the last years in all field of physics. The idea is very simple and consists in the observation that a theory with hamiltonian invariant under a symmetry group may not show explicitly the symmetry at the level of the solutions. As we shall see this may happen when the following conditions are realized:

- The theory is invariant under a symmetry group G .
- The fundamental state of the theory is degenerate and transforms in a non trivial way under the symmetry group.

Just as an example consider a scalar field described by a lagrangian invariant under parity

$$P : \phi \rightarrow -\phi \quad (6.59)$$

The lagrangian density will be of the type

$$\mathcal{L} = \frac{1}{2} \partial_\mu \phi \partial^\mu \phi - V(\phi^2) \quad (6.60)$$

If the vacuum state is non degenerate, barring a phase factor, we must have

$$P|0\rangle = |0\rangle \quad (6.61)$$

since P commutes with the hamiltonian. It follows

$$\langle 0|\phi|0\rangle = \langle 0|P^{-1}P\phi P^{-1}P|0\rangle = \langle 0|P\phi P^{-1}|0\rangle = -\langle 0|\phi|0\rangle \quad (6.62)$$

from which

$$\langle 0|\phi|0\rangle = 0 \quad (6.63)$$

Things change if the fundamental state is degenerate. This would be the case in the example (6.60), if

$$V(\phi^2) = \frac{\mu^2}{2}\phi^2 + \frac{\lambda}{4}\phi^4 \quad (6.64)$$

with $\mu^2 < 0$. In fact, this potential has two minima located at

$$\phi = \pm v, \quad v = \sqrt{-\frac{\mu^2}{\lambda}} \quad (6.65)$$

By denoting with $|R\rangle$ e $|L\rangle$ the two states corresponding to the classical configurations $\phi = \pm v$, we have

$$P|R\rangle = |L\rangle \neq |R\rangle \quad (6.66)$$

Therefore

$$\langle R|\phi|R\rangle = \langle R|P^{-1}P\phi P^{-1}P|R\rangle = -\langle L|\phi|L\rangle \quad (6.67)$$

which now does not imply that the expectation value of the field vanishes. In the following we will be rather interested in the case of continuous symmetries. So let us consider two scalar fields, and a lagrangian density with symmetry $O(2)$

$$\mathcal{L} = \frac{1}{2}\partial_\mu\vec{\phi} \cdot \partial^\mu\vec{\phi} - \frac{1}{2}\mu^2\vec{\phi} \cdot \vec{\phi} - \frac{\lambda}{4}(\vec{\phi} \cdot \vec{\phi})^2 \quad (6.68)$$

where

$$\vec{\phi} \cdot \vec{\phi} = \phi_1^2 + \phi_2^2 \quad (6.69)$$

For $\mu^2 > 0$ there is a unique fundamental state (minimum of the potential) $\vec{\phi} = 0$, whereas for $\mu^2 < 0$ there are infinite degenerate states given by

$$|\vec{\phi}|^2 = \phi_1^2 + \phi_2^2 = v^2 \quad (6.70)$$

with v defined as in (6.65). By denoting with $R(\theta)$ the operator rotating the fields in the plane (ϕ_1, ϕ_2) , in the non-degenerate case we have

$$R(\theta)|0\rangle = |0\rangle \quad (6.71)$$

and

$$\langle 0|\phi|0\rangle = \langle 0|R^{-1}R\phi R^{-1}|0\rangle = \langle 0|\phi^\theta|0\rangle = 0 \quad (6.72)$$

since $\phi^\theta \neq \phi$. In the case $\mu^2 < 0$ (degenerate case), we have

$$R(\theta)|0\rangle = |\theta\rangle \quad (6.73)$$

where $|\theta\rangle$ is one of the infinitely many degenerate fundamental states lying on the circle $|\vec{\phi}|^2 = v^2$. Then

$$\langle 0|\phi_i|0\rangle = \langle 0|R^{-1}(\theta)R(\theta)\phi_i R^{-1}(\theta)R(\theta)|0\rangle = \langle \theta|\phi_i^\theta|\theta\rangle \quad (6.74)$$

with

$$\phi_i^\theta = R(\theta)\phi_i R^{-1}(\theta) \neq \phi_i \quad (6.75)$$

Again, the expectation value of the field (contrarily to the non-degenerate state) does not need to vanish. The situation can be described qualitatively saying that the existence of a degenerate fundamental state forces the system to choose one of these equivalent states, and consequently to break the symmetry. But the breaking is only at the level of the solutions, the lagrangian and the equations of motion preserve the symmetry. One can easily construct classical systems exhibiting spontaneous symmetry breaking. For instance, a classical particle in a double-well potential. This system has parity invariance $x \rightarrow -x$, where x is the particle position. The equilibrium positions are around the minima positions, $\pm x_0$. If we put the particle close to x_0 , it will perform oscillations around that point and the original symmetry is lost. A further example is given by a ferromagnet which has an hamiltonian invariant under rotations, but below the Curie temperature exhibits spontaneous magnetization, breaking in this way the symmetry. These situations are typical for the so called second order phase transitions. One can describe them through the Landau free-energy, which depends on two different kind of parameters:

- **Control parameters**, as μ^2 for the scalar field, and the temperature for the ferromagnet.
- **Order parameters**, as the expectation value of the scalar field or as the magnetization.

The system goes from one phase to another varying the control parameters, and the phase transition is characterized by the order parameters which assume different values in different phases. In the previous examples, the order parameters were zero in the symmetric phase and different from zero in the broken phase.

The situation is slightly more involved at the quantum level, since spontaneous symmetry breaking cannot happen in finite systems. This follows from the existence of the tunnel effect. Let us consider again a particle in a double-well potential, and recall that we have defined the fundamental states through the correspondence with the classical minima

$$\begin{aligned} x = x_0 &\rightarrow |R\rangle \\ x = -x_0 &\rightarrow |L\rangle \end{aligned} \quad (6.76)$$

But the tunnel effect gives rise to a transition between these two states and as a consequence it removes the degeneracy. In fact, due to the transition the hamiltonian acquires a non zero matrix element between the states $|R\rangle$ and $|L\rangle$. By denoting with \underline{H} the matrix of the hamiltonian between these two states, we get

$$\underline{H} = \begin{bmatrix} \epsilon_0 & \epsilon_1 \\ \epsilon_1 & \epsilon_0 \end{bmatrix} \quad (6.77)$$

The eigenvalues of \underline{H} are

$$(\epsilon_0 + \epsilon_1, \epsilon_0 - \epsilon_1) \quad (6.78)$$

We have no more degeneracy and the eigenstates are

$$|S\rangle = \frac{1}{\sqrt{2}}(|R\rangle + |L\rangle) \quad (6.79)$$

with eigenvalue $E_S = \epsilon_0 + \epsilon_1$, and

$$|A\rangle = \frac{1}{\sqrt{2}}(|R\rangle - |L\rangle) \quad (6.80)$$

with eigenvalue $E_A = \epsilon_0 - \epsilon_1$. One can show that $\epsilon_1 < 0$ and therefore the fundamental state is the symmetric one, $|S\rangle$. This situation gives rise to the well known effect of quantum oscillations. We can express the states $|R\rangle$ and $|L\rangle$ in terms of the energy eigenstates

$$\begin{aligned} |R\rangle &= \frac{1}{\sqrt{2}}(|S\rangle + |A\rangle) \\ |L\rangle &= \frac{1}{\sqrt{2}}(|S\rangle - |A\rangle) \end{aligned} \quad (6.81)$$

Let us now prepare a state, at $t = 0$, by putting the particle in the right minimum. This is not an energy eigenstate and its time evolution is given by

$$|R, t\rangle = \frac{1}{\sqrt{2}} \left(e^{-iE_S t} |S\rangle + e^{-iE_A t} |A\rangle \right) = \frac{1}{\sqrt{2}} e^{-iE_S t} \left(|S\rangle + e^{-it\Delta E} |A\rangle \right) \quad (6.82)$$

with $\Delta E = E_A - E_S$. Therefore, for $t = \pi/\Delta E$ the state $|R\rangle$ transforms into the state $|L\rangle$. The state oscillates with a period given by

$$T = \frac{2\pi}{\Delta E} \quad (6.83)$$

In nature there are finite systems as sugar molecules, which seem to exhibit spontaneous symmetry breaking. In fact one observes right-handed and left-handed sugar molecules. The explanation is simply that the energy difference ΔE is so small that the oscillation period is of the order of $10^4 - 10^6$ years.

The splitting of the fundamental states decreases with the height of the potential between two minima, therefore, for infinite systems, the previous mechanism does not work, and we may have spontaneous symmetry breaking. In fact, coming back to the scalar field example, its expectation value on the vacuum must be a constant, as it follows from the translational invariance of the vacuum

$$\langle 0|\phi(x)|0\rangle = \langle 0|e^{iPx}\phi(0)e^{-iPx}|0\rangle = \langle 0|\phi(0)|0\rangle = v \quad (6.84)$$

and the energy difference between the maximum at $\phi = 0$, and the minimum at $\phi = v$, becomes infinite in the limit of infinite volume

$$H(\phi = 0) - H(\phi = v) = - \int_V d^3x \left[\frac{\mu^2}{2}v^2 + \frac{\lambda}{4}v^4 \right] = \frac{\mu^4}{4\lambda} \int_V d^3x = \frac{\mu^4}{4\lambda}V \quad (6.85)$$

6.3 The Goldstone theorem

From our point of view, the most interesting consequence of spontaneous symmetry breaking is the Goldstone theorem. This theorem says that for any continuous symmetry spontaneously broken, there exists a massless particle (the Goldstone boson). The theorem holds rigorously in a local field theory, under the following hypotheses

- The spontaneous broken symmetry must be a continuous one.
- The theory must be manifestly covariant.
- The Hilbert space of the theory must have a definite positive norm.

We will limit ourselves to analyze the theorem in the case of a classical scalar field theory. Let us start considering the lagrangian for the linear σ -model with invariance $O(N)$

$$\mathcal{L} = \frac{1}{2} \partial_\mu \vec{\phi} \cdot \partial^\mu \vec{\phi} - \frac{\mu^2}{2} \vec{\phi} \cdot \vec{\phi} - \frac{\lambda}{4} (\vec{\phi} \cdot \vec{\phi})^2 \quad (6.86)$$

The conditions that V must satisfy in order to have a minimum are

$$\frac{\partial V}{\partial \phi_l} = \mu^2 \phi_l + \lambda \phi_l |\vec{\phi}|^2 = 0 \quad (6.87)$$

with solutions

$$\phi_l = 0, \quad |\vec{\phi}|^2 = v^2, \quad v = \sqrt{\frac{-\mu^2}{\lambda}} \quad (6.88)$$

The character of the stationary points can be studied by evaluating the second derivatives

$$\frac{\partial^2 V}{\partial \phi_l \partial \phi_m} = \delta_{lm} (\mu^2 + \lambda |\vec{\phi}|^2) + 2\lambda \phi_l \phi_m \quad (6.89)$$

We have two possibilities

- $\mu^2 > 0$, we have only one real solution given by $\vec{\phi} = 0$, which is a minimum, since

$$\frac{\partial^2 V}{\partial \phi_l \partial \phi_m} = \delta_{lm} \mu^2 > 0 \quad (6.90)$$

- $\mu^2 < 0$, there are infinite solutions, among which $\vec{\phi} = 0$ is a maximum. The points of the sphere $|\vec{\phi}|^2 = v^2$ are degenerate minima. In fact, by choosing $\phi_l = v \delta_{lN}$ as a representative point, we get

$$\frac{\partial^2 V}{\partial \phi_l \partial \phi_m} = 2\lambda v^2 \delta_{lN} \delta_{mN} > 0 \quad (6.91)$$

Expanding the potential around this minimum we get

$$V(\vec{\phi}) \approx V|_{\text{minimum}} + \frac{1}{2} \frac{\partial^2 V}{\partial \phi_l \partial \phi_m} \Big|_{\text{minimum}} (\phi_l - v\delta_{lN})(\phi_m - v\delta_{mN}) \quad (6.92)$$

If we are going to make a perturbative expansion, the right fields to be used are $\phi_l - v\delta_{lN}$, and their mass is just given by the coefficient of the quadratic term

$$M_{lm}^2 = \frac{\partial^2 V}{\partial \phi_l \partial \phi_m} \Big|_{\text{minimo}} = -2\mu^2 \delta_{lN} \delta_{mN} = \begin{bmatrix} 0 & 0 & \cdot & 0 \\ 0 & 0 & \cdot & 0 \\ \cdot & \cdot & \cdot & \cdot \\ 0 & 0 & \cdot & -2\mu^2 \end{bmatrix} \quad (6.93)$$

Therefore the masses of the fields ϕ_a , $a = 1, \dots, N-1$, and $\chi = \phi_N - v$, are given by

$$m_{\phi_a}^2 = 0, \quad m_\chi^2 = -2\mu^2 \quad (6.94)$$

By defining

$$m^2 = -2\mu^2 \quad (6.95)$$

we can write the potential as a function of the new fields

$$V = \frac{m^4}{16\lambda} + \frac{1}{2} m^2 \chi^2 + \sqrt{\frac{m^2 \lambda}{2}} \chi \left(\sum_{a=1}^{N-1} \phi_a^2 + \chi^2 \right) + \frac{\lambda}{4} \left(\sum_{a=1}^{N-1} \phi_a^2 + \chi^2 \right)^2 \quad (6.96)$$

In this form the original symmetry $O(N)$ is broken. However a residual symmetry $O(N-1)$ is left. In fact, V depends only on the combination $\sum_{a=1}^{N-1} \phi_a^2$, and it is invariant under rotations around the axis we have chosen as representative for the fundamental state, $(0, \dots, v)$. It must be stressed that this is not the most general potential invariant under $O(N-1)$. In fact the most general potential (up to the fourth order in the fields) describing N scalar fields with a symmetry $O(N-1)$ would depend on 7 coupling constants, whereas the one we got depends only on the two parameters m and λ . Therefore spontaneous symmetry breaking puts heavy constraints on the dynamics of the system. We have also seen that we have $N-1$ massless scalars. Clearly the rotations along the first $N-1$ directions leave the potential invariant, whereas the $N-1$ rotations on the planes $a-N$ move away from the surface of the minima. This can be seen also in terms of generators. Since the field we have chosen as representative of the ground state is $\phi_i|_{\text{min}} = v\delta_{iN}$, we have

$$T_{ij}^{ab} \phi_j|_{\text{min}} = i(\delta_i^a \delta_j^b - \delta_i^b \delta_j^a) v \delta_{jN} = 0 \quad (6.97)$$

since $a, b = 1, \dots, N-1$, and

$$T_{ij}^{aN} \phi_j|_{\text{min}} = i(\delta_i^a \delta_j^N - \delta_i^N \delta_j^a) v \delta_{jN} = i v \delta_i^a \neq 0 \quad (6.98)$$

Therefore we have $N-1$ broken symmetries and $N-1$ massless scalars. The generators of $O(N)$ divide up naturally in the generators of the vacuum symmetry

(here $O(N-1)$), and in the so called broken generators, each of them corresponding to a massless Goldstone boson. In general, if the original symmetry group G of the theory is spontaneously broken down to a subgroup H (which is the symmetry of the vacuum), the Goldstone bosons correspond to the generators of G which are left after subtracting the generators of H . Intuitively one can understand the origin of the massless particles noticing that the broken generators allow transitions from a possible vacuum to another. Since these states are degenerate the operation does not cost any energy. From the relativistic dispersion relation this implies that we must have massless particles. One can say that Goldstone bosons correspond to flat directions in the potential.

6.4 QED as a gauge theory

Many field theories possess global symmetries. These are transformations leaving invariant the action of the system and are characterized by a certain number of parameters which are independent on the space-time point. As a prototype we can consider the free Dirac lagrangian

$$\mathcal{L}_0 = \bar{\psi}(x)[i\not{\partial} - m]\psi(x) \quad (6.99)$$

which is invariant under the global phase transformation

$$\psi(x) \rightarrow \psi'(x) = e^{-iQ\alpha}\psi(x) \quad (6.100)$$

If one has more than one field, Q is a diagonal matrix having as eigenvalues the charges of the different fields measured in unit e . For instance, a term as $\bar{\psi}_2\psi_1\phi$, with ϕ a scalar field, is invariant by choosing $Q(\psi_1) = Q(\phi) = 1$, and $Q(\psi_2) = 2$. This is a so called **abelian symmetry** since

$$e^{-i\alpha Q}e^{-i\beta Q} = e^{-i(\alpha + \beta)Q} = e^{-i\beta Q}e^{-i\alpha Q} \quad (6.101)$$

It is also referred to as a $U(1)$ symmetry. The physical meaning of this invariance lies in the possibility of assigning the phase to the fields in an arbitrary way, without changing the observable quantities. This way of thinking is in some sort of contradiction with causality, since it requires to assign the phase of the fields simultaneously at all space-time points. It looks more physical to require the possibility of assigning the phase in an arbitrary way at each space-time point. This invariance, formulated by Weyl in 1929, was called gauge invariance. The free lagrangian (6.99) cannot be gauge invariant due to the derivative coming from the kinetic term. The idea is simply to generalize the derivative ∂_μ to a so called covariant derivative D_μ having the property that $D_\mu\psi$ transforms as ψ , that is

$$D_\mu\psi(x) \rightarrow [D_\mu\psi(x)]' = e^{-iQ\alpha(x)}D_\mu\psi(x) \quad (6.102)$$

In this case the term

$$\bar{\psi}D_\mu\psi \quad (6.103)$$

will be invariant as the mass term under the local phase transformation. To construct the covariant derivative, we need to enlarge the field content of the theory, by introducing a vector field, the **gauge field** A_μ , in the following way

$$D_\mu = \partial_\mu + ieQA_\mu \quad (6.104)$$

The transformation law of A_μ is obtained from eq. (6.102)

$$\begin{aligned} [(\partial_\mu + ieQA_\mu)\psi]' &= (\partial_\mu + ieQA'_\mu)\psi'(x) \\ &= (\partial_\mu + ieQA'_\mu)e^{-iQ\alpha(x)}\psi \\ &= e^{-iQ\alpha(x)} \left[\partial_\mu + ieQ(A'_\mu - \frac{1}{e}\partial_\mu\alpha) \right] \psi \end{aligned} \quad (6.105)$$

from which

$$A'_\mu = A_\mu + \frac{1}{e}\partial_\mu\alpha \quad (6.106)$$

The lagrangian density

$$\mathcal{L}_\psi = \bar{\psi}[i\not{D} - m]\psi = \bar{\psi}[i\gamma^\mu(\partial_\mu + ieQA_\mu) - m]\psi = \mathcal{L}_0 - e\bar{\psi}Q\gamma^\mu\psi A_\mu \quad (6.107)$$

is then invariant under gauge transformations, or under the local group $U(1)$. We see also that by requiring local invariance we reproduce the electromagnetic interaction as obtained through the minimal substitution we discussed before.

In order to determine the kinetic term for the vector field A_μ we notice that eq. (6.102) implies that under a gauge transformation, the covariant derivative undergoes a unitary transformation

$$D_\mu \rightarrow D'_\mu = e^{-iQ\alpha(x)}D_\mu e^{iQ\alpha(x)} \quad (6.108)$$

Then, also the commutator of two covariant derivatives

$$[D_\mu, D_\nu] = [\partial_\mu + ieQA_\mu, \partial_\nu + ieQA_\nu] = ieQF_{\mu\nu} \quad (6.109)$$

with

$$F_{\mu\nu} = \partial_\mu A_\nu - \partial_\nu A_\mu \quad (6.110)$$

transforms in the same way

$$F_{\mu\nu} \rightarrow e^{-iQ\alpha(x)}F_{\mu\nu}e^{iQ\alpha(x)} = F_{\mu\nu} \quad (6.111)$$

The last equality follows from the commutativity of $F_{\mu\nu}$ with the phase factor. The complete lagrangian density is then

$$\mathcal{L} = \mathcal{L}_\psi + \mathcal{L}_A = \bar{\psi}[i\gamma^\mu(\partial_\mu + ieQA_\mu) - m]\psi - \frac{1}{4}F_{\mu\nu}F^{\mu\nu} \quad (6.112)$$

The gauge principle has automatically generated an interaction between the gauge field and the charged field. We notice also that gauge invariance prevents any mass term, $\frac{1}{2}M^2 A^\mu A_\mu$. Therefore, the photon field is massless. Also, since the local invariance implies the global ones, by using the Noether's theorem we find the conserved current as

$$j_\mu = \frac{\partial \mathcal{L}}{\partial \psi_{,\mu}} \delta \psi = \bar{\psi} \gamma_\mu (Q \alpha) \psi \quad (6.113)$$

from which, eliminating the infinitesimal parameter α ,

$$J_\mu = \bar{\psi} \gamma_\mu Q \psi \quad (6.114)$$

6.5 Non-abelian gauge theories

The approach of the previous section can be easily extended to local non-abelian symmetries. We will consider the case of N Dirac fields. The free lagrangian

$$\mathcal{L}_0 = \sum_{a=1}^N \bar{\psi}_a (i \not{\partial} - m) \psi_a \quad (6.115)$$

is invariant under the global transformation

$$\Psi(x) \rightarrow \Psi'(x) = A \Psi(x) \quad (6.116)$$

where A is a unitary $N \times N$ matrix, and we have denoted by Ψ the column vector with components ψ_a . In a more general situation the actual symmetry could be a subgroup of $U(N)$. For instance, when the masses are not all equal. So we will consider here the gauging of a subgroup G of $U(N)$. The fields $\psi_a(x)$ will belong, in general, to some reducible representation of G . Denoting by U the generic element of G , we will write the corresponding matrix U_{ab} acting upon the fields ψ_a as

$$U = e^{-i\alpha_A T^A}, \quad U \in G \quad (6.117)$$

where T^A denote the generators of the Lie algebra associated to G , $\text{Lie}(G)$, (that is the vector space spanned by the infinitesimal generators of the group) in the fermion representation. The generators T^A satisfy the algebra

$$[T^A, T^B] = i f_C^{AB} T^C \quad (6.118)$$

where f_C^{AB} are the structure constants of $\text{Lie}(G)$. For instance, if $G = SU(2)$, and we take the fermions in the fundamental representation,

$$\Psi = \begin{bmatrix} \psi_1 \\ \psi_2 \end{bmatrix} \quad (6.119)$$

we have

$$T^A = \frac{\sigma^A}{2}, \quad A = 1, 2, 3 \quad (6.120)$$

where σ^A are the Pauli matrices. In the general case the T^A 's are $N \times N$ hermitian matrices that we will choose normalized in such a way that

$$\text{Tr}(T^A T^B) = \frac{1}{2} \delta^{AB} \quad (6.121)$$

To make local the transformation (6.117), means to promote the parameters α_A to space-time functions

$$\alpha_A \rightarrow \alpha_A(x) \quad (6.122)$$

Notice, that now the group does not need to be abelian, and therefore, in general

$$e^{-i\alpha_A T^A} e^{-i\beta_A T^A} \neq e^{-i\beta_A T^A} e^{-i\alpha_A T^A} \quad (6.123)$$

Let us now proceed to the case of the local symmetry by defining again the concept of covariant derivative

$$D_\mu \Psi(x) \rightarrow [D_\mu \Psi(x)]' = U(x) [D_\mu \psi(x)] \quad (6.124)$$

We will put again

$$D_\mu = \partial_\mu + ig B_\mu \quad (6.125)$$

where B_μ is a $N \times N$ matrix acting upon $\Psi(x)$. In components

$$D_{ab}^\mu = \delta_{ab} \partial^\mu + ig (B^\mu)_{ab} \quad (6.126)$$

The eq. (6.124) implies

$$\begin{aligned} D_\mu \Psi &\rightarrow (\partial_\mu + ig B'_\mu) U(x) \Psi \\ &= U(x) \partial_\mu \Psi + U(x) [U^{-1}(x) ig B'_\mu U(x)] \Psi + (\partial_\mu U(x)) \Psi \\ &= U(x) [\partial_\mu + U^{-1}(x) ig B'_\mu U(x) + U^{-1}(x) \partial_\mu U(x)] \Psi \end{aligned} \quad (6.127)$$

therefore

$$U^{-1}(x) ig B'_\mu U(x) + U^{-1}(x) \partial_\mu U(x) = ig B_\mu \quad (6.128)$$

and

$$B'_\mu(x) = U(x) B_\mu(x) U^{-1}(x) + \frac{i}{g} (\partial_\mu U(x)) U^{-1}(x) \quad (6.129)$$

For an infinitesimal transformation

$$U(x) \approx 1 - i\alpha_A(x) T^A \quad (6.130)$$

we get

$$\delta B_\mu(x) = -i\alpha_A(x) [T^A, B_\mu(x)] + \frac{1}{g} (\partial_\mu \alpha_A(x)) T^A \quad (6.131)$$

Since $B_\mu(x)$ acquires a term proportional to T^A , the transformation law is consistent with a B_μ linear in the generators of the Lie algebra, that is

$$(B^\mu)_{ab} \equiv A_A^\mu (T^A)_{ab} \quad (6.132)$$

The transformation law for A_μ becomes

$$\delta A_C^\mu = f_C^{AB} \alpha_A A_B^\mu + \frac{1}{g} \partial^\mu \alpha_C \quad (6.133)$$

The difference with respect to the abelian case is that the field undergoes also a homogeneous transformation.

The kinetic term for the gauge fields is constructed as in the abelian case. In fact the quantity

$$[D_\mu, D_\nu] \Psi \equiv ig F_{\mu\nu} \Psi \quad (6.134)$$

in virtue of the eq. (6.124), transforms as Ψ under gauge transformations, that is

$$\begin{aligned} ([D_\mu, D_\nu] \Psi)' &= ig F'_{\mu\nu} \Psi' = ig F'_{\mu\nu} U(x) \Psi \\ &= U(x) ([D_\mu, D_\nu] \Psi) = U(x) (ig F_{\mu\nu}) \Psi \end{aligned} \quad (6.135)$$

This time the tensor $F_{\mu\nu}$ is not invariant but transforms homogeneously, since it does not commute with the gauge transformation as in the abelian case

$$F'_{\mu\nu} = U(x) F_{\mu\nu} U^{-1}(x) \quad (6.136)$$

The invariant kinetic term will be assumed as

$$\mathcal{L}_A = -\frac{1}{2} \text{Tr}[F_{\mu\nu} F^{\mu\nu}] \quad (6.137)$$

Let us now evaluate $F_{\mu\nu}$

$$\begin{aligned} ig F_{\mu\nu} &= [D_\mu, D_\nu] = [\partial_\mu + ig B_\mu, \partial_\nu + ig B_\nu] \\ &= ig(\partial_\mu B_\nu - \partial_\nu B_\mu) - g^2 [B_\mu, B_\nu] \end{aligned} \quad (6.138)$$

or

$$F_{\mu\nu} = (\partial_\mu B_\nu - \partial_\nu B_\mu) + ig [B_\mu, B_\nu] \quad (6.139)$$

in components

$$F^{\mu\nu} = F_C^{\mu\nu} T^C \quad (6.140)$$

with

$$F_C^{\mu\nu} = \partial^\mu A_C^\nu - \partial^\nu A_C^\mu - gf_C^{AB} A_A^\mu A_B^\nu \quad (6.141)$$

The main feature of the non-abelian gauge theories is the bilinear term in the previous expression. Such a term comes because $f_C^{AB} \neq 0$, expressing the fact that G is not abelian. The kinetic term for the gauge field, expressed in components, is given by

$$\mathcal{L}_A = -\frac{1}{4} \sum_A F_{\mu\nu A} F_A^{\mu\nu} \quad (6.142)$$

Therefore, whereas in the abelian case \mathcal{L}_A is a free lagrangian (it contains only quadratic terms), now it contains interaction terms cubic and quartic in the fields.

The physical motivation lies in the fact that the gauge fields couple to everything which transforms in a non trivial way under the gauge group. Therefore they couple also to themselves (remember the homogeneous piece of transformation).

To derive the equations of motion for the gauge fields, let us consider the total action

$$\int_V d^4x \left[\bar{\Psi}(i\not{\partial} - m)\Psi - g\bar{\Psi}\gamma_\mu B^\mu\Psi \right] + S_A \quad (6.143)$$

where

$$S_A = -\frac{1}{2} \int_V d^4x \text{Tr}(F_{\mu\nu}F^{\mu\nu}) \quad (6.144)$$

and the variation of S_A

$$\delta S_A = - \int_V d^4x \text{Tr}(F_{\mu\nu}\delta F^{\mu\nu}) \quad (6.145)$$

Using the definition (6.139) for the field strength we get

$$\delta F_{\mu\nu} = \partial_\mu\delta B_\nu - \partial_\nu\delta B_\mu + ig(\delta B_\mu)B_\nu - igB_\mu(\delta B_\nu) - (\mu \leftrightarrow \nu) \quad (6.146)$$

from which

$$\delta S_A = -2 \int_V d^4x \text{Tr}[F^{\mu\nu}(\partial_\mu\delta B_\nu - \partial_\nu\delta B_\mu + ig(\delta B_\mu)B_\nu - igB_\mu(\delta B_\nu))] \quad (6.147)$$

where we have taken into account the antisymmetry properties of $F_{\mu\nu}$. Integrating by parts we obtain

$$\begin{aligned} \delta S_A &= -2 \int_V d^4x \text{Tr}[-(\partial_\mu F^{\mu\nu})\delta B_\nu - igB_\mu F^{\mu\nu}\delta B_\nu + igF^{\mu\nu}B_\mu\delta B_\nu] \\ &= 2 \int_V d^4x \text{Tr}[(\partial_\mu F^{\mu\nu} + ig[B_\mu, F^{\mu\nu}])\delta B_\nu] \\ &= \int_V d^4x (\partial_\mu F^{\mu\nu} + ig[B_\mu, F^{\mu\nu}])_A \delta A_{\nu A} \end{aligned} \quad (6.148)$$

where we used the cyclic property of the trace. By taking into account also the free term for the Dirac fields and the interaction we find the equations of motion

$$\begin{aligned} \partial_\mu F^{\mu\nu A} + ig[B_\mu, F^{\mu\nu}]^A &= g\bar{\Psi}\gamma^\nu T^A\Psi \\ (i\not{\partial} - m)\Psi &= g\gamma_\mu B^\mu\Psi \end{aligned} \quad (6.149)$$

From the first equation we see that the currents $\bar{\Psi}\gamma_\mu T^A\Psi$ are not conserved. In fact the conserved currents turn out to be

$$J_\nu^A = \bar{\Psi}\gamma_\nu T^A\Psi - i[B^\mu, F_{\mu\nu}]^A \quad (6.150)$$

The reason is that under a global transformation of the symmetry group, the gauge fields are not invariant, said in different words they are charged fields with respect

to the gauge fields. In fact we can verify immediately that the previous currents are precisely the Noether's currents. Under a global variation we have

$$\delta A_C^\mu = f_C^{AB} \alpha_A A_B^\mu, \quad \delta \Psi = -i \alpha_A T^A \Psi \quad (6.151)$$

and we get

$$j^\mu = \frac{\partial \mathcal{L}}{\partial \Psi_{,\mu}} \delta \Psi + \frac{\partial \mathcal{L}}{\partial A_{\nu,\mu C}} \delta A_{\nu C} \quad (6.152)$$

from which

$$j^\mu = \bar{\Psi} \gamma^\mu \alpha_A T^A \Psi - F_C^{\mu\nu} f_C^{AB} \alpha_A A_{\nu B} \quad (6.153)$$

In the case of simple compact Lie groups one can define $f^{ABC} = f_C^{AB}$ with the property $f^{ABC} = f^{BCA}$. It follows

$$F_C^{\mu\nu} f^{ABC} A_{\nu B} T^A = i[B^\nu, F_{\nu\mu}] \equiv i[B^\nu, F_{\nu\mu}]^A T^A \quad (6.154)$$

Therefore

$$j^\mu = \bar{\Psi} \gamma^\mu \alpha_A T^A \Psi - i[B_\nu, F^{\nu\mu}]^A \alpha_A \quad (6.155)$$

After division by α_A we get the Noether's currents (6.150). The contribution of the gauge fields to the currents is also crucial in order they are conserved quantities. In fact, the divergence of the fermionic contribution is given by

$$\partial^\mu (\bar{\Psi} \gamma_\mu T^A \Psi) = -ig \bar{\Psi} \gamma_\mu T^A B^\mu \Psi + ig \bar{\Psi} \gamma_\mu B^\mu T^A \Psi = -ig \bar{\Psi} \gamma_\mu [T^A, B^\mu] \Psi \quad (6.156)$$

which vanishes for abelian gauge fields, whereas it is compensated by the gauge fields contribution in the non abelian case.

6.6 The Higgs mechanism

We have seen that the spontaneous symmetry breaking mechanism, in the case of continuous symmetry leads to massless scalar particles, the Goldstone bosons. Also gauge theories lead to massless vector bosons, in fact, as in the electromagnetic case, gauge invariance forbids the presence in the lagrangian of terms quadratic in the fields. Unfortunately in nature the only massless particles we know are the photon and perhaps the neutrinos, which however are fermions. But once one couples spontaneous symmetry breaking to a gauge symmetry, things change. In fact, if we look back at the hypotheses underlying a gauge theory, it turns out that Goldstone theorem does not hold in this context. The reason is that it is impossible to quantize a gauge theory in a way which is at the same time manifestly covariant and has a Hilbert space with positive definite metric. This is well known already for the electromagnetic field, where one has to choose the gauge before quantization. What happens is that, if one chooses a physical gauge, as the Coulomb gauge, in order to have a Hilbert space spanned by only the physical states, than the theory loses the manifest covariance. If one goes to a covariant gauge, as the Lorentz one, the

theory is covariant but one has to work with a big Hilbert space, with non-definite positive metric, and where the physical states are extracted through a supplementary condition. The way in which the Goldstone theorem is evaded is that the Goldstone bosons disappear, and, at the same time, the gauge bosons corresponding to the broken symmetries acquire mass. This is the famous **Higgs mechanism**.

Let us start with a scalar theory invariant under $O(2)$

$$\mathcal{L} = \frac{1}{2} \partial_\mu \vec{\phi} \cdot \partial^\mu \vec{\phi} - \frac{\mu^2}{2} \vec{\phi} \cdot \vec{\phi} - \frac{\lambda}{4} (\vec{\phi} \cdot \vec{\phi})^2 \quad (6.157)$$

and let us analyze the spontaneous symmetry breaking mechanism. If $\mu^2 < 0$ the symmetry is broken and we can choose the vacuum as the state

$$\vec{\phi} = (v, 0), \quad v = \sqrt{\frac{-\mu^2}{\lambda}} \quad (6.158)$$

After the translation $\phi_1 = \chi + v$, with $\langle 0 | \chi | 0 \rangle = 0$, we get the potential ($m^2 = -2\mu^2$)

$$V = -\frac{m^4}{16\lambda} + \frac{1}{2} m^2 \chi^2 + \sqrt{\frac{m^2 \lambda}{2}} \chi (\phi_2^2 + \chi^2) - \frac{\lambda}{4} (\phi_2^2 + \chi^2)^2 \quad (6.159)$$

In this case the group $O(2)$ is completely broken (except for the discrete symmetry $\phi_2 \rightarrow -\phi_2$). The Goldstone field is ϕ_2 . This has a peculiar way of transforming under $O(2)$. In fact, the original fields transform as

$$\delta\phi_1 = -\alpha\phi_2, \quad \delta\phi_2 = \alpha\phi_1 \quad (6.160)$$

from which

$$\delta\chi = -\alpha\phi_2, \quad \delta\phi_2 = \alpha\chi + \alpha v \quad (6.161)$$

We see that the Goldstone field undergoes a rotation plus a translation, αv . This is the main reason for the Goldstone particle to be massless. In fact one can have invariance under translations of the field, only if the potential is flat in the corresponding direction. This is what happens when one moves in a way which is tangent to the surface of the degenerate vacuums (in this case a circle). How do things change if our theory is gauge invariant? In that case we should have invariance under a transformation of the Goldstone field given by

$$\delta\phi_2(x) = \alpha(x)\chi(x) + \alpha(x)v \quad (6.162)$$

Since $\alpha(x)$ is an arbitrary function of the space-time point, it follows that we can choose it in such a way to make $\phi_2(x)$ vanish. In other words it must be possible to eliminate the Goldstone field from the theory. This is better seen by using polar coordinates for the fields, that is

$$\rho = \sqrt{\phi_1^2 + \phi_2^2}, \quad \sin \theta = \frac{\phi_2}{\sqrt{\phi_1^2 + \phi_2^2}} \quad (6.163)$$

Under a finite rotation, the new fields transform as

$$\rho \rightarrow \rho, \quad \theta \rightarrow \theta + \alpha \quad (6.164)$$

It should be also noticed that the two coordinate systems coincide when we are close to the vacuum, as when we are doing perturbation theory. In fact, in that case we can perform the following expansion

$$\rho = \sqrt{\phi_2^2 + \chi^2 + 2\chi v + v^2} \approx v + \chi, \quad \theta \approx \frac{\phi_2}{v + \chi} \approx \frac{\phi_2}{v} \quad (6.165)$$

Again, if we make the theory invariant under a local transformation, we will have invariance under

$$\theta(x) \rightarrow \theta(x) + \alpha(x) \quad (6.166)$$

By choosing $\alpha(x) = -\theta(x)$ we can eliminate this last field from the theory. The only remaining degree of freedom in the scalar sector is $\rho(x)$.

Let us study the gauging of this model. It is convenient to introduce complex variables

$$\phi = \frac{1}{\sqrt{2}}(\phi_1 + i\phi_2), \quad \phi^\dagger = \frac{1}{\sqrt{2}}(\phi_1 - i\phi_2) \quad (6.167)$$

The $O(2)$ transformations become phase transformations on ϕ

$$\phi \rightarrow e^{i\alpha} \phi \quad (6.168)$$

and the lagrangian (6.157) can be written as

$$\mathcal{L} = \partial_\mu \phi^\dagger \partial^\mu \phi - \mu^2 \phi^\dagger \phi - \lambda(\phi^\dagger \phi)^2 \quad (6.169)$$

We know that it is possible to promote a global symmetry to a local one by introducing the covariant derivative

$$\partial_\mu \phi \rightarrow (\partial_\mu + igA_\mu)\phi \quad (6.170)$$

from which

$$\mathcal{L} = (\partial_\mu - igA_\mu)\phi^\dagger (\partial^\mu + igA^\mu)\phi - \mu^2 \phi^\dagger \phi - \lambda(\phi^\dagger \phi)^2 - \frac{1}{4}F_{\mu\nu}F^{\mu\nu} \quad (6.171)$$

In terms of the polar coordinates (ρ, θ) we have

$$\phi = \frac{1}{\sqrt{2}}\rho e^{i\theta}, \quad \phi^\dagger = \frac{1}{\sqrt{2}}\rho e^{-i\theta} \quad (6.172)$$

By performing the following gauge transformation on the scalars

$$\phi \rightarrow \phi' = \phi e^{-i\theta} \quad (6.173)$$

and the corresponding transformation on the gauge fields

$$A_\mu \rightarrow A'_\mu = A_\mu + \frac{1}{g} \partial_\mu \theta \quad (6.174)$$

the lagrangian will depend only on the fields ρ and A'_μ (we will put again $A'_\mu = A_\mu$)

$$\mathcal{L} = \frac{1}{2} (\partial_\mu - igA_\mu) \rho (\partial^\mu + igA_\mu) \rho - \frac{\mu^2}{2} \rho^2 - \frac{\lambda}{4} \rho^4 - \frac{1}{4} F_{\mu\nu} F^{\mu\nu} \quad (6.175)$$

In this way the Goldstone boson disappears. We have now to translate the field ρ

$$\rho = \chi + v, \quad \langle 0 | \chi | 0 \rangle = 0 \quad (6.176)$$

and we see that this generates a bilinear term in A_μ , coming from the covariant derivative, given by

$$\frac{1}{2} g^2 v^2 A_\mu A^\mu \quad (6.177)$$

Therefore the gauge field acquires a mass

$$m_A^2 = g^2 v^2 \quad (6.178)$$

It is instructive to count the degrees of freedom before and after the gauge transformation. Before we had 4 degrees of freedom, two from the scalar fields and two from the gauge field. After the gauge transformation we have only one degree of freedom from the scalar sector, but three degrees of freedom from the gauge vector, because now it is a massive vector field. The result looks a little bit strange, but the reason why we may read clearly the number of degrees of freedom only after the gauge transformation is that before the lagrangian contains a mixing term

$$A_\mu \partial^\mu \theta \quad (6.179)$$

between the Goldstone field and the gauge vector which makes complicate to read the mass of the states. The previous gauge transformation realizes the purpose of making that term vanish. The gauge in which such a thing happens is called the **unitary gauge**.

We will consider now the further example of a symmetry $O(N)$. The lagrangian invariant under local transformations is

$$\mathcal{L} = \frac{1}{2} (D_\mu)_{ij} \phi_j (D^\mu)_{ik} \phi_k - \frac{\mu^2}{2} \phi_i \phi_i - \frac{\lambda}{4} (\phi_i \phi_i)^2 \quad (6.180)$$

where

$$(D_\mu)_{ij} = \delta_{ij} \partial_\mu + i \frac{g}{2} (T^{AB})_{ij} W_\mu^{AB} \quad (6.181)$$

where $(T^{AB})_{lm} = i(\delta_l^A \delta_m^B - \delta_m^A \delta_l^B)$. In the case of broken symmetry ($\mu^2 < 0$), we choose again the vacuum along the direction N , with v defined as in (6.158)

$$\phi_i = v \delta_{iN} \quad (6.182)$$

Recalling that

$$T_{ij}^{ab} \phi_j \Big|_{\min} = 0, \quad T_{ij}^{aN} \phi_j \Big|_{\min} = iv \delta_i^a, \quad a, b = 1, \dots, N-1 \quad (6.183)$$

the mass term for the gauge field is given by

$$\begin{aligned} & -\frac{1}{8} g^2 T_{ij}^{AB} \phi_j \Big|_{\min} (T^{CD})_{ik} \phi_k \Big|_{\min} W_\mu^{AB} W^{\mu CD} \\ &= -\frac{1}{2} g^2 T_{ij}^{aN} \phi_j \Big|_{\min} (T^{bN})_{ik} \phi_k \Big|_{\min} W_\mu^{aN} W^{\mu bN} \\ &= \frac{1}{2} g^2 v^2 \delta_i^a \delta_i^b W_\mu^{aN} W^{\mu bN} = \frac{1}{4} g^2 v^2 W_\mu^{aN} W^{\mu bN} \end{aligned} \quad (6.184)$$

Therefore, the fields W_μ^{aN} associated to the broken directions T^{aN} acquire a mass $g^2 v^2/2$, whereas W_μ^{ab} , associated to the unbroken symmetry $O(N-1)$, remain massless.

In general, if G is the global symmetry group of the lagrangian, H the subgroup of G leaving invariant the vacuum, and G_W the group of local (gauge) symmetries, $G_W \in G$, one can divide up the broken generators in two categories. In the first category fall the broken generators lying in G_W ; they have associated massive vector bosons. In the second category fall the other broken generators; they have associated massless Goldstone bosons. Finally the gauge fields associated to generators of G_W lying in H remain massless. From the previous derivation this follows noticing that the generators of H annihilate the minimum of the fields, leaving the corresponding gauge bosons massless, whereas the non zero action of the broken generators generate a mass term for the other gauge fields.

The situation is represented in Fig. 6.1.

We can now show how to eliminate the Goldstone bosons. In fact we can define new fields ξ_a and χ as

$$\phi_i = \left(e^{-iT^{aN} \xi_a} \right)_{iN} (\chi + v) \quad (6.185)$$

where $a = 1, \dots, N-1$, that is the sum is restricted to the broken directions. The other degree of freedom is in the other factor. The correspondence among the fields $\vec{\phi}$ and (ξ_a, χ) can be seen easily by expanding around the vacuum

$$\left(e^{-iT^{aN} \xi_a} \right)_{iN} \approx \delta_{iN} - i(T^{aN})_{iN} \xi_a = \delta_{iN} + \delta_i^a \xi_a \quad (6.186)$$

from which

$$\phi_i \approx (v \xi_a, \chi + v) \quad (6.187)$$

showing that the ξ_a 's are really the Goldstone fields. The unitary gauge is defined through the transformation

$$\phi_i \rightarrow \left(e^{iT^{aN} \xi_a} \right)_{ij} \phi_j = \delta_{iN} (\chi + v) \quad (6.188)$$

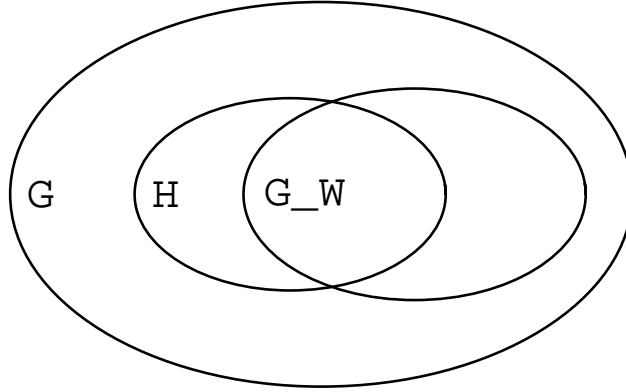

Fig. 6.1 - This figure shows the various groups, G , the global symmetry of the lagrangian, $H \in G$, the symmetry of the vacuum, and G_W , the group of local symmetries. The broken generators in G_W correspond to massive vector bosons. The broken generators do not belonging to G_W correspond to massless Goldstone bosons. The unbroken generators in G_W correspond to massless vector bosons.

$$W_\mu \rightarrow e^{iT^{aN}\xi_a} W_\mu e^{-iT^{aN}\xi_a} - \frac{i}{g} \left(\partial_\mu e^{iT^{aN}\xi_a} \right) e^{-iT^{aN}\xi_a} \quad (6.189)$$

This transformation eliminates the Goldstone degrees of freedom and the resulting lagrangian depends on the field χ , on the massive vector fields W_μ^{aN} and on the massless field W_μ^{ab} . Notice again the counting of the degrees of freedom $N + 2N(N - 1)/2 = N^2$ in a generic gauge, and $1 + 3(N - 1) + 2(N - 1)(N - 2)/2 = N^2$ in the unitary gauge.

Chapter 7

Time ordered products

7.1 Time ordered products and propagators.

One of the most relevant quantities in perturbative field theory is the propagator, that is the vacuum expectation value of a time ordered product of two fields. To introduce the propagator from a physical point of view we will consider a charged Klein-Gordon. As we know from Section 3.6, the field ϕ destroys a particle of charge +1 and creates a particle of charge -1 . In any case the net variation of the charge is -1 . In analogous way the field ϕ^\dagger gives rise to a net variation of the charge equal to $+1$. Let us now construct a state with charge $+1$ applying ϕ^\dagger to the vacuum

$$|\psi(\vec{y}, t)\rangle = \phi^\dagger(y)|0\rangle = \int \frac{d^3k}{\sqrt{2\omega_k(2\pi)^3}} e^{iky} |\vec{k}, m, 1\rangle \quad (7.1)$$

where $|\vec{k}, m, 1\rangle$ is the single particle state with charge $+1$, momentum \vec{k} and mass m . We want to evaluate the probability amplitude for the state, $|\psi(\vec{y}, t)\rangle$, to propagate to the same state, $|\psi(\vec{x}, t')\rangle$, at a later time $t' > t$. This is given by the matrix element

$$\theta(t' - t) \langle \psi(\vec{x}, t') | \psi(\vec{y}, t) \rangle = \theta(t' - t) \langle 0 | \phi(\vec{x}, t') \phi^\dagger(\vec{y}, t) | 0 \rangle \quad (7.2)$$

It turns out to be convenient to think to this matrix element as the one corresponding to the creation of a charge $+1$ at the point \vec{y} and time t , and to its annihilation at the point \vec{x} and time t' . This interpretation is a correct one, since the state $|\psi(\vec{y}, t)\rangle$ is eigenstate of the charge density operator

$$\rho(\vec{z}, t) |\psi(\vec{y}, t)\rangle = [\rho(\vec{z}, t), \phi^\dagger(\vec{y}, t)] |0\rangle = +\delta^3(\vec{z} - \vec{y}) \phi^\dagger(\vec{y}, t) |0\rangle = \delta^3(\vec{z} - \vec{y}) |\psi(\vec{y}, t)\rangle \quad (7.3)$$

where we have used eq. (3.197)

$$\rho =: i\phi^\dagger \partial_t^{(-)} \phi : \quad (7.4)$$

and the canonical commutation relations.

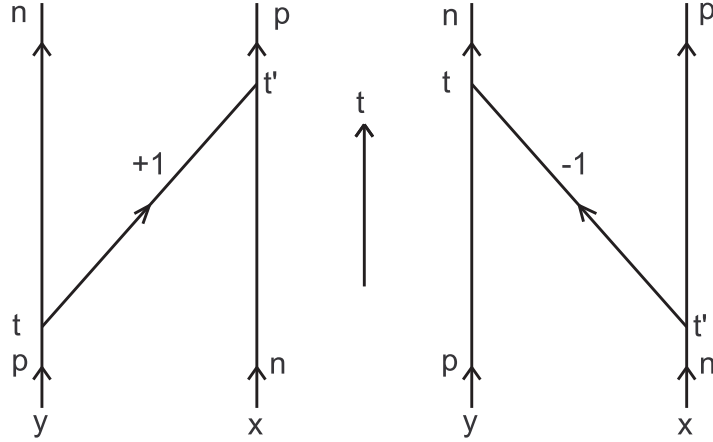

Fig. 7.1 - The two probability amplitudes contributing to the process $np \rightarrow np$.

However for $t' < t$ we could reach the same result by creating a particle of charge -1 at (\vec{x}, t') , and annihilating it at (\vec{y}, t) . The corresponding amplitude is

$$\theta(t - t') \langle 0 | \phi^\dagger(\vec{y}, t) \phi(\vec{x}, t') | 0 \rangle \quad (7.5)$$

The situation is represented in Fig. 7.1, where we have considered the case of a charged particle exchanged between a proton (charge +1) and a neutron (charge 0). The total amplitude is obtained by adding the two contributions together. We define the vacuum expectation value of the time ordered product (T product) of two fields as

$$\begin{aligned} \langle 0 | T(\phi(x) \phi^\dagger(y)) | 0 \rangle &= \langle 0 | T(\phi^\dagger(y) \phi(x)) | 0 \rangle \\ &= \theta(x_0 - y_0) \langle 0 | \phi(x) \phi^\dagger(y) | 0 \rangle + \theta(y_0 - x_0) \langle 0 | \phi(y) \phi^\dagger(x) | 0 \rangle \\ &\equiv -i \Delta_F(x - y) \end{aligned} \quad (7.6)$$

The function $\Delta_F(x - y)$ is called the Feynman propagator, and we will show immediately that it depends indeed on the difference of the two coordinates x and y . Using the expressions (3.193) for the fields, we find

$$\begin{aligned} -i \Delta_F(x - y) &= \int d^3k d^3k' \left[\theta(x_0 - y_0) f_{\vec{k}}^*(y) f_{\vec{k}'}(x) \langle 0 | a(\vec{k}') a^\dagger(\vec{k}) | 0 \rangle \right. \\ &\quad \left. + \theta(y_0 - x_0) f_{\vec{k}}(y) f_{\vec{k}'}^*(x) \langle 0 | b(\vec{k}') b^\dagger(\vec{k}) | 0 \rangle \right] \\ &= \int \frac{d^3k}{(2\pi)^3} \frac{1}{2\omega_k} \left[\theta(x_0 - y_0) e^{-ik(x - y)} \right. \\ &\quad \left. + \theta(y_0 - x_0) e^{ik(x - y)} \right] \end{aligned} \quad (7.7)$$

where, we recall that $k_0 = \omega_k$. This expression can be written in a more convenient way by using the following integral representation of the step function

$$\theta(t) = \lim_{\eta \rightarrow 0^+} \frac{i}{2\pi} \int d\omega \frac{e^{-i\omega t}}{\omega + i\eta} \quad (7.8)$$

This representation can be verified immediately by noticing that for $t < 0$ the integral is convergent in the upper complex half-plane of ω . Since there are no singularities in this region (the integral has a pole at $\omega = -i\eta$), we see that the integral vanishes. In the case $t > 0$ the integral is convergent in the lower half-plane. Then we pick up the contribution of the pole (in a clockwise direction) and we find

$$-i\Delta_F(x-y) = i \int \frac{d^3k}{(2\pi)^4} \int d\omega \frac{1}{2\omega_k} \left[\frac{e^{-i\omega(x_0-y_0)}}{\omega+i\eta} e^{-ik(x-y)} + \frac{e^{i\omega(x_0-y_0)}}{\omega+i\eta} e^{ik(x-y)} \right] \quad (7.9)$$

By the following change of variable $k_0 = \omega + \omega_k$, we get

$$\begin{aligned} -i\Delta_F(x-y) &= i \int \frac{d^4k}{(2\pi)^4} \frac{1}{2\omega_k} \left[\frac{e^{-ik(x-y)}}{k_0 - \omega_k + i\eta} + \frac{e^{ik(x-y)}}{k_0 - \omega_k + i\eta} \right] \\ &= i \int \frac{d^4k}{(2\pi)^4} \frac{1}{2\omega_k} e^{-ik(x-y)} \left[\frac{1}{k_0 - \omega_k + i\eta} - \frac{1}{k_0 + \omega_k - i\eta} \right] \\ &= i \int \frac{d^4k}{(2\pi)^4} \frac{e^{-ik(x-y)}}{k^2 - m^2 + i\epsilon} \end{aligned} \quad (7.10)$$

where we have defined $\epsilon = 2\eta\omega_k$. Notice that ϵ is a positive quantity. Then

$$\Delta_F(x-y) = - \int \frac{d^4k}{(2\pi)^4} \frac{e^{-ik(x-y)}}{k^2 - m^2 + i\epsilon} \quad (7.11)$$

From this representation it follows that $\Delta_F(x)$ is a Green function for the Klein-Gordon operator

$$(\partial^2 + m^2)\Delta_F(x) = \delta^4(x) \quad (7.12)$$

That the T -product is a Green function for the Klein-Gordon operator is a simple consequence of its very definition, by using the canonical commutators

$$\begin{aligned} &(\partial^2 + m^2)_x \langle 0|T(\phi(x)\phi^\dagger(y))|0\rangle = \partial_0^2 \langle 0|T(\phi(x)\phi^\dagger(y))|0\rangle \\ &+ \langle 0|T((-\vec{\nabla}_x^2 + m^2)\phi(x)\phi^\dagger(y))|0\rangle \\ &= \partial_0 \langle 0|\delta(x_0 - y_0)[\phi(x), \phi^\dagger(y)]|0\rangle + \partial_0 \langle 0|T(\dot{\phi}(x)\phi^\dagger(y))|0\rangle \\ &+ \langle 0|T((-\vec{\nabla}_x^2 + m^2)\phi(x)\phi^\dagger(y))|0\rangle \\ &= \langle 0|\delta(x_0 - y_0)[\dot{\phi}(x), \phi^\dagger(y)]|0\rangle + \langle 0|T((\partial_x^2 + m^2)\phi(x)\phi^\dagger(y))|0\rangle \\ &= -i\delta^4(x-y) \end{aligned} \quad (7.13)$$

It is easily seen that an analogous result holds for the hermitian Klein-Gordon field, that is

$$\Delta_F(x-y) = i\langle 0|T(\phi(x)\phi(y))|0\rangle \quad (7.14)$$

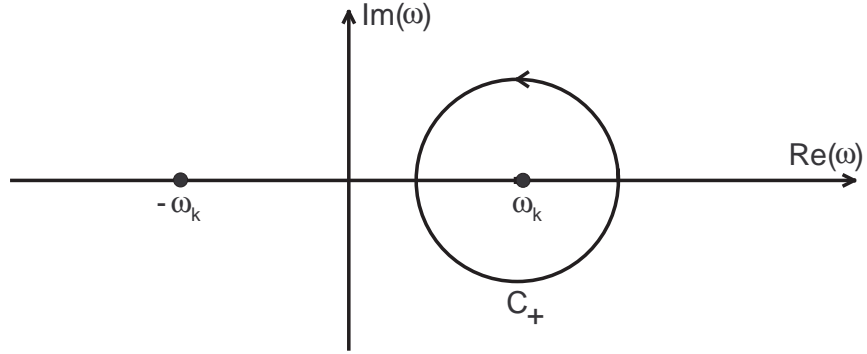

Fig. 7.2 - The integration path C_+ .

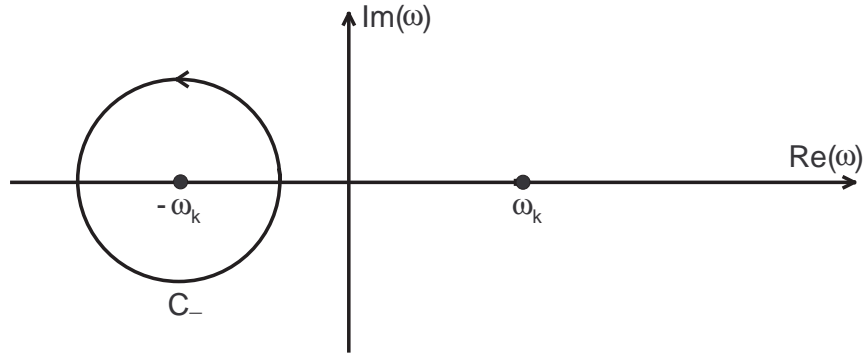

Fig. 7.3 - The integration path C_- .

All the invariant functions we have encountered so far can be obtained by specifying in a convenient way the integration path of the following integral

$$\Delta_C(x) = \int_C \frac{d^4k}{(2\pi)^4} \frac{e^{-ikx}}{k^2 - m^2} \quad (7.15)$$

In fact the integrand has two poles in k_0 , which are located at $k_0 = \pm\omega_k$, with $\omega_k = \sqrt{|\vec{k}|^2 + m^2}$. To define the integral we need to specify how the integration path goes around the poles. In particular, we can define the two integration paths C_{\pm} given in Figs. 7.2 and 7.3. Correspondingly we have the following integrals

$$\Delta^{(\pm)}(x) = -i \int_{C_{\pm}} \frac{d^4k}{(2\pi)^4} \frac{e^{-ikx}}{k^2 - m^2} \quad (7.16)$$

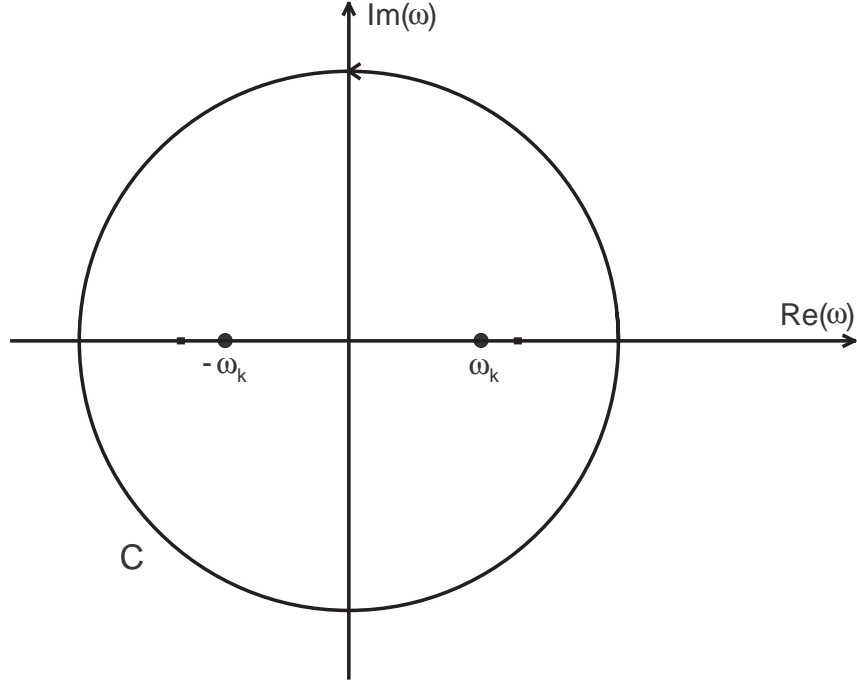

Fig. 7.4 - The integration path C

We find

$$\Delta^{(+)}(x) = -i \int_{C_+} \frac{d^4 k}{(2\pi)^4} \frac{e^{-ikx}}{(k_0 - \omega_k)(k_0 + \omega_k)} = \int \frac{d^3 k}{(2\pi)^3} \frac{e^{-ikx}}{2\omega_k} = [\phi^{(+)}(x), \phi^{(-)}(y)] \quad (7.17)$$

where we have used eq. (3.149). Also

$$\Delta^{(-)}(x) = - \int \frac{d^3 k}{(2\pi)^3} \frac{e^{ikx}}{2\omega_k} = -\Delta^{(+)\dagger}(x) = [\phi^{(-)}(x), \phi^{(+)}(y)] \quad (7.18)$$

It follows

$$\Delta^{(+)}(x) + \Delta^{(-)}(x) = i\Delta(x) \quad (7.19)$$

and using eq. (3.147), $i\Delta(x - y) = [\phi(x), \phi(y)]$. Therefore the commutator can be represented as

$$\Delta(x) = - \int_C \frac{d^4 k}{(2\pi)^4} \frac{e^{-ikx}}{k^2 - m^2} \quad (7.20)$$

with C given in Fig. 7.4.

In the case of Δ_F , the poles position is the one in Fig. 7.5. Then it can be also defined by taking the poles on the real axis and choosing an integration path C_F , as specified in Fig. 7.6. That is

$$\Delta_F(x) = - \int_{C_F} \frac{d^4 k}{(2\pi)^4} \frac{e^{-ikx}}{k^2 - m^2} \quad (7.21)$$

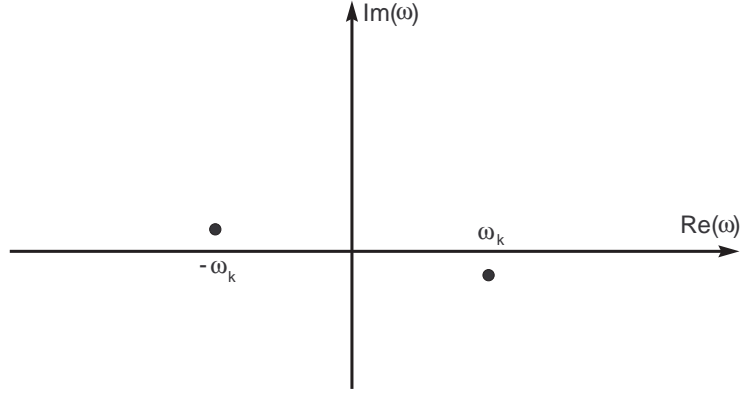

Fig. 7.5 - The position of the poles in the definition of $\Delta_F(x)$.

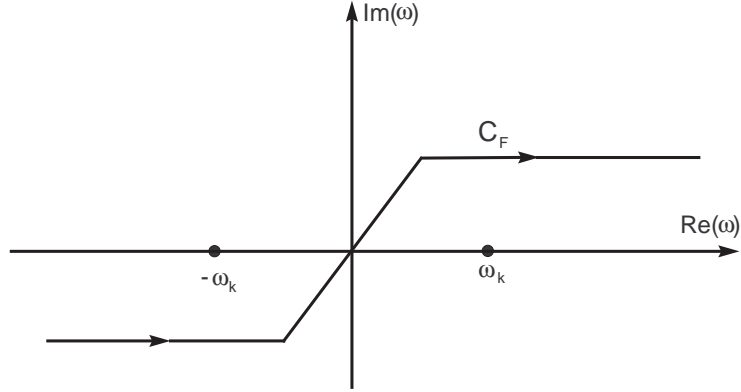

Fig. 7.6 - The integration path C_F .

Using eqs. (7.7), (7.17) and (7.18), we see that

$$\Delta_F(x) = i\theta(x_0)\Delta^{(+)}(x) - i\theta(-x_0)\Delta^{(-)}(x) \quad (7.22)$$

Let us also notice that all the Δ_C invariant functions defined on a close path C , satisfy the homogeneous Klein-Gordon equation. In fact, the action of the Klein-Gordon operator removes the singularities from the integrand, leaving the integral of an analytic function, which vanishes due to the Cauchy theorem.

For a free Dirac field, the Feynman propagator has a similar definition

$$S_F(x - y)_{\alpha\beta} = -i\langle 0|T(\psi_\alpha(x)\bar{\psi}_\beta(y))|0\rangle \quad (7.23)$$

but with the T -product defined as follows

$$T(\psi_\alpha(x)\bar{\psi}_\beta(y)) = \theta(x_0 - y_0)\psi_\alpha(x)\bar{\psi}_\beta(y) - \theta(y_0 - x_0)\bar{\psi}_\beta(y)\psi_\alpha(x) \quad (7.24)$$

Notice that

$$T(\psi_\alpha(x)\bar{\psi}_\beta(y)) = -T(\bar{\psi}_\beta(y)\psi_\alpha(x)) \quad (7.25)$$

(an analogous property holds for the Klein-Gordon case, but with a plus sign). The minus sign introduced in the definition of the T -product for the Dirac field, is needed because only in this way it may represent the Green function for the Dirac operator. In fact

$$\begin{aligned}
& (i\hat{\partial}_x - m)_{\alpha\beta} T(\psi_\beta(x)\bar{\psi}_\gamma(y)) \\
&= i(\gamma_0)_{\alpha\beta} \delta(x_0 - y_0) [\psi_\beta(x), \bar{\psi}_\gamma(y)]_+ = i\delta(x_0 - y_0) (\gamma_0)_{\alpha\beta} (\gamma_0)_{\beta\gamma} \delta^3(\vec{x} - \vec{y}) \\
&= i\delta^4(x - y) \delta_{\alpha\gamma}
\end{aligned} \tag{7.26}$$

that is

$$(i\hat{\partial} - m)S_F(x) = \delta^4(x) \tag{7.27}$$

It is clear that the choice of sign is related to the way in which we perform the canonical quantization. From the property of S_F of being the Green function of the Dirac operator, we can see that

$$S_F(x) = -(i\hat{\partial} + m)\Delta_F(x) \tag{7.28}$$

and

$$S_F(x) = \int \frac{d^4k}{(2\pi)^4} e^{-ikx} \frac{\hat{k} + m}{k^2 - m^2 + i\epsilon} = \int_{C_F} \frac{d^4k}{(2\pi)^4} e^{-ikx} \frac{\hat{k} + m}{k^2 - m^2} \tag{7.29}$$

Finally we consider the photon propagator. The only difference with the Klein-Gordon case is that the polarization vector give an extra factor $-g_{\mu\nu}$, and therefore

$$\langle 0|T(A_\mu(x)A_\nu(y)|0\rangle = -ig_{\mu\nu} \int \frac{d^4k}{(2\pi)^4} \frac{e^{-ikx}}{k^2 + i\epsilon} \tag{7.30}$$

Defining

$$D(x) = - \int \frac{d^4k}{(2\pi)^4} \frac{e^{-ikx}}{k^2 + i\epsilon} \tag{7.31}$$

we get

$$\langle 0|T(A_\mu(x)A_\nu(y)|0\rangle = +ig_{\mu\nu}D(x - y) \tag{7.32}$$

7.2 A physical application of the propagators

The choice of the integration paths in eq. (7.15) allows us to define various types of Green's functions according to the boundary conditions we require. Suppose that we want to solve the Klein-Gordon in a given external source

$$(\partial^2 + m^2)\phi(x) = j(x) \tag{7.33}$$

The solution can be given in terms of the Green's function defined by

$$(\partial^2 + m^2)G(x) = \delta^4(x) \tag{7.34}$$

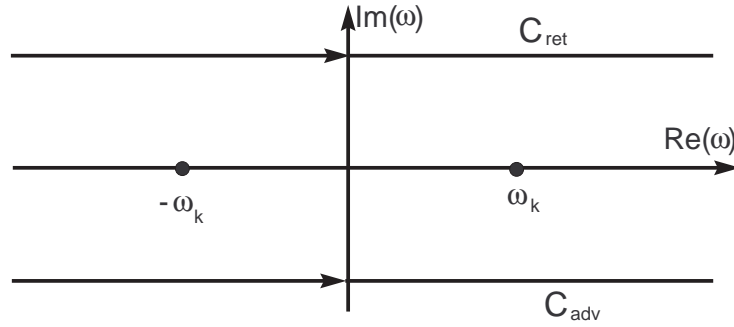

Fig. 7.7 - The integration paths for G_{ret} and G_{adv} .

In fact,

$$\phi(x) = \phi^{(0)}(x) + \int d^4y G(x-y)j(y) \quad (7.35)$$

where $\phi^{(0)}(x)$ satisfy the homogeneous Klein-Gordon equation and it is chosen in such a way that $\phi(x)$ satisfies the boundary conditions of the problem. For instance, if we give the the function $\phi(x)$ at $t = -\infty$ we may require

$$\lim_{t \rightarrow -\infty} \phi(x) = \lim_{t \rightarrow -\infty} \phi^{(0)}(x) \quad (7.36)$$

Then, to satisfy the boundary conditions it is enough to choose for $G(x)$ the retarded solution defined by

$$G_{\text{ret}}(\vec{x}, x_0 < 0) = 0 \quad (7.37)$$

Such a solution can be found easily by applying the method we have illustrated in the previous Section. By choosing the integration path as in Fig. 7.7, that is, leaving both poles below the path we get

$$G_{\text{ret}}(x) = - \int_{C_{\text{ret}}} \frac{d^4k}{(2\pi)^4} \frac{e^{-ikx}}{k^2 - m^2} \quad (7.38)$$

Clearly $G_{\text{ret}}(x)$ vanishes for $x_0 < 0$. In fact, in this case, we can close the path on the half-plane $\text{Im } \omega > 0$ without hitting any singularity, therefore the function vanishes. In analogous way we can define a function $G_{\text{adv}}(x)$ vanishing for $x_0 > 0$, by choosing a path below the poles (see Fig. 7.7). By integrating explicitly over ω one sees easily that the retarded solution propagates forward in time both the positive and negative energy solutions, whereas the advanced one propagates both solutions backward in time. By using the expression (7.7) for the Feynman propagator we see that it propagates the positive energy solutions forward in time and the negative energy ones backward in time. In fact, Feynman and Stueckelberg showed that the backward propagation of the negative energy solutions is equivalent to the forward propagation of the anti-particles. The Feynman propagator acquires its full meaning only in the quantum theory, where, as we shall prove, it represents the central element of the perturbation theory.

In order to stress the relevance of the Feynman propagator we will consider now a simple application of what we have learned so far. Let us consider two static point-like electric charges placed at \vec{x}_1 and \vec{x}_2 . They can be described by the charge density

$$j_0(\vec{x}) = \sum_{m=1,2} e_m \delta^3(\vec{x} - \vec{x}_m) \quad (7.39)$$

where e_m are the values of the electric charges. The current density vanishes because we have supposed the charges to be static. Therefore the interaction hamiltonian is

$$H_{\text{int}} = -L_{\text{int}} = \int d^3x j_\mu(x) A^\mu(x) = \sum_{m=1,2} e_m A_0(\vec{x}_m, 0) \quad (7.40)$$

In this equation we have taken the electromagnetic field operator A_0 at the time $t = 0$, because in this case it will be more convenient to use the Schrödinger representation. We have worked so far with the Heisenberg representation because it turns out to be more convenient from the point of view of the relativistic covariance of the formalism, but the problem we will be interested here is the evaluation of the interaction energy between the two charges. We recall that the Heisenberg and the Schrödinger representation, as far as the operators are concerned, are related by

$$A_H(t) = e^{iHt} A_S e^{-iHt} \quad (7.41)$$

where $A_H(t)$ is the operator in the Heisenberg representation and A_S is the operator in the Schrödinger one. Therefore the two operators are the same at $t = 0$. To evaluate the interaction energy we can do a perturbative calculation by evaluating the energy shift induced by the interaction hamiltonian. Since the electric charges are classical we are quantizing only the photon field $A_0(\vec{x}, 0)$, and the state that we are perturbing is the vacuum state (the state without photons). Since

$$\langle 0 | H_{\text{int}} | 0 \rangle = 0 \quad (7.42)$$

we must evaluate the energy shift at the second order in the perturbative theory. We will have

$$\Delta E = \sum_n \frac{\langle 0 | H_{\text{int}} | n \rangle \langle n | H_{\text{int}} | 0 \rangle}{E_0 - E_n} = \int \frac{d^3k}{-\omega_k} \langle 0 | H_{\text{int}} | \vec{k} \rangle \langle \vec{k} | H_{\text{int}} | 0 \rangle \quad (7.43)$$

The only state which contributes in the sum is the state with a single photon of energy ω_k . By using the expression for H_{int} and the following representation for $1/\omega_k$

$$\frac{1}{\omega_k} = \lim_{\epsilon \rightarrow 0^+} i \int_0^\infty dt e^{-i(\omega_k - i\epsilon)t} \quad (7.44)$$

we can write ΔE in the form (notice that we have suppressed the limit because the resulting expression is regular at for $\epsilon \rightarrow 0^+$).

$$\Delta E = -i \sum_{m,n} e_m e_n \int d^3k \int_0^\infty dt e^{-i\omega_k t} \langle 0 | A_0(\vec{x}_n, 0) | \vec{k} \rangle \langle \vec{k} | A_0(\vec{x}_m, 0) | 0 \rangle$$

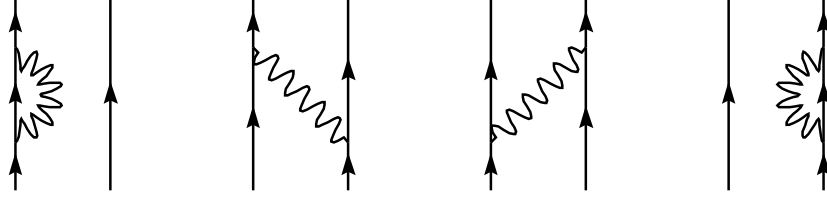

Fig. 7.8 - The graphical description of eq. (7.46).

$$\begin{aligned}
&= -i \sum_{m,n} e_m e_n \int d^3k \int dt \theta(t) \langle 0 | e^{iH_0 t} A_0(\vec{x}_n, 0) e^{-iH_0 t} |\vec{k}\rangle \langle \vec{k} | A_0(\vec{x}_m, 0) | 0 \rangle \\
&= -i \sum_{m,n} \int dt \theta(t) \langle 0 | A_0(\vec{x}_n, t) A_0(\vec{x}_m, 0) | 0 \rangle
\end{aligned} \tag{7.45}$$

where H_0 is the free hamiltonian for the electromagnetic field. To get this expression we have used the completeness (recalling again that A_0 couples only states that differ by a photon), and now the operators appearing in the last line can be interpreted as operators in the Heisenberg representation. By writing explicitly the various terms in the sum we get

$$\begin{aligned}
\Delta E &= -i \int dt \theta(t) \left[e_1^2 \langle 0 | A_0(\vec{x}_1, t) A_0(\vec{x}_1, 0) | 0 \rangle + e_1 e_2 \langle 0 | A_0(\vec{x}_1, t) A_0(\vec{x}_2, 0) | 0 \rangle \right. \\
&\quad \left. + e_1 e_2 \langle 0 | A_0(\vec{x}_2, t) A_0(\vec{x}_1, 0) | 0 \rangle + e_2^2 \langle 0 | A_0(\vec{x}_2, t) A_0(\vec{x}_2, 0) | 0 \rangle \right]
\end{aligned} \tag{7.46}$$

The intermediate states description of these four contributions is given in Fig. 7.8. Notice that the first and the fourth diagram describe a correction to the intrinsic properties of the charges, and since we are interested in the evaluation of the interaction energy we can omit them from our calculation. Then, the energy interaction ΔE_{12} is given by

$$\begin{aligned}
\Delta E_{12} &= -ie_1 e_2 \int dt \theta(t) \left[\langle 0 | A_0(\vec{x}_1, t) A_0(\vec{x}_2, 0) | 0 \rangle \right. \\
&\quad \left. + \langle 0 | A_0(\vec{x}_2, t) A_0(\vec{x}_1, 0) | 0 \rangle \right]
\end{aligned} \tag{7.47}$$

Sending $t \rightarrow -t$ in the second term, we get

$$\begin{aligned}
\Delta E_{12} &= -ie_1 e_2 \int dt \left[\theta(t) \langle 0 | A_0(\vec{x}_1, t) A_0(\vec{x}_2, 0) | 0 \rangle \right. \\
&\quad \left. + \theta(-t) \langle 0 | A_0(\vec{x}_2, -t) A_0(\vec{x}_1, 0) | 0 \rangle \right]
\end{aligned} \tag{7.48}$$

and using $H_0|0\rangle = 0$,

$$\begin{aligned}
\langle 0 | A_0(\vec{x}_2, -t) A_0(\vec{x}_1, 0) | 0 \rangle &= \langle 0 | e^{-iH_0 t} A_0(\vec{x}_2, 0) e^{iH_0 t} A_0(\vec{x}_1, 0) e^{-iH_0 t} | 0 \rangle \\
&= \langle 0 | A_0(\vec{x}_2, 0) A_0(\vec{x}_1, t) | 0 \rangle
\end{aligned} \tag{7.49}$$

Therefore our final result is

$$\Delta E_{12} = -ie_1e_2 \int dt \langle 0|T(A_0(\vec{x}_1, t)A_0(\vec{x}_2, 0))|0\rangle \quad (7.50)$$

We see that the energy interaction is expressed in terms of the Feynman propagator. Recalling the eqs.(7.31) and (7.32) we get

$$\begin{aligned} \Delta E_{12} &= -e_1e_2 \int dt \int \frac{d^4k}{(2\pi)^4} \frac{e^{-ik(x_1 - x_2)}}{k^2 + i\epsilon} \\ &= e_1e_2 \int \frac{d^3k}{(2\pi)^3} \frac{e^{i\vec{k}(\vec{x}_1 - \vec{x}_2)}}{\vec{k}^2} = \frac{e_1e_2}{4\pi} \frac{1}{|\vec{x}_1 - \vec{x}_2|} \end{aligned} \quad (7.51)$$

To evaluate the integration over

$$\vec{\nabla}^2 \int \frac{d^3k}{(2\pi)^3} \frac{e^{i\vec{k} \cdot \vec{x}}}{|\vec{k}|^2} = -\delta^3(\vec{x}) \quad (7.52)$$

and

$$\vec{\nabla}^2 \frac{1}{|\vec{x}|} = -4\pi\delta^3(\vec{x}) \quad (7.53)$$

from which

$$\int \frac{d^3k}{(2\pi)^3} \frac{e^{i\vec{k} \cdot \vec{x}}}{|\vec{k}|^2} = \frac{1}{4\pi} \frac{1}{|\vec{x}|} \quad (7.54)$$

Chapter 8

Perturbation theory

8.1 The electromagnetic interaction

As we already discussed the electromagnetic interaction can be introduced for an arbitrary charged particle via the minimal substitution or invoking the gauge principle

$$\partial_\mu \rightarrow \partial_\mu + ieA_\mu \quad (8.1)$$

For instance, in the Klein-Gordon case one gets the lagrangian density for a charged field given by

$$\begin{aligned} \mathcal{L}_{\text{free}} &= \partial_\mu \phi^\dagger \partial^\mu \phi - m^2 \phi^\dagger \phi - \frac{1}{4} F_{\mu\nu} F^{\mu\nu} \rightarrow \\ &\rightarrow [(\partial_\mu + ieA_\mu)\phi]^\dagger [(\partial^\mu + ieA^\mu)\phi] - m^2 \phi^\dagger \phi - \frac{1}{4} F_{\mu\nu} F^{\mu\nu} \end{aligned} \quad (8.2)$$

In this case the interacting part is given by

$$\mathcal{L}_{\text{int.}} = -ie [\phi^\dagger \partial_\mu \phi - (\partial_\mu \phi^\dagger) \phi] A^\mu + e^2 A^2 \phi^\dagger \phi \quad (8.3)$$

We see that the gauge field is coupled to the current

$$j_\mu = ie [\phi^\dagger \partial_\mu \phi - (\partial_\mu \phi^\dagger) \phi] \quad (8.4)$$

but another interacting term appears. This term is a straight consequence of the gauge invariance. In fact the current j_μ which was conserved in absence of the interaction is now neither conserved, neither gauge invariant. Consider the infinitesimal gauge transformation

$$\delta\phi(x) = -ie\Lambda(x)\phi(x), \quad \delta A_\mu(x) = \partial_\mu \Lambda(x) \quad (8.5)$$

then

$$\delta\mathcal{L}_{\text{free}} = ie\Lambda_{,\mu}\phi^\dagger\partial^\mu\phi - ie\partial_\mu\phi^\dagger\Lambda^{,\mu}\phi = j^\mu\partial_\mu\Lambda \quad (8.6)$$

and writing \mathcal{L}_{int} in the form

$$\mathcal{L}_{\text{int}} = -j_\mu A^\mu + e^2 A^2 \phi^\dagger \phi \quad (8.7)$$

we find

$$\delta\mathcal{L}_{\text{int}} = -j_\mu \Lambda^{,\mu} - (\delta j_\mu) A^\mu + 2e^2 \Lambda_{,\mu} A^\mu \phi^\dagger \phi \quad (8.8)$$

The first term cancels with the variation of $\mathcal{L}_{\text{free}}$, whereas the other two terms cancel among themselves

$$\delta j_\mu = ie \left[\phi^\dagger (-ie) \Lambda_{,\mu} \phi - ie \Lambda_{,\mu} \phi^\dagger \phi \right] = 2e^2 \Lambda_{,\mu} \phi^\dagger \phi \quad (8.9)$$

This shows that the A^2 term is necessary to compensate the fact that $\delta j_\mu \neq 0$ since the current is not gauge invariant. In fact the conserved and gauge invariant current comes by using the Noether's theorem

$$J_\mu = ie \left[\phi^\dagger (\partial_\mu + ie A_\mu) \phi - (\partial_\mu - ie A_\mu) \phi^\dagger \phi \right] = j_\mu - 2e^2 A_\mu \phi^\dagger \phi \quad (8.10)$$

The situation is far more simple in the case of the Dirac equation where

$$\mathcal{L}_{\text{free}} = \bar{\psi} (i\hat{\partial} - m) \psi - \frac{1}{4} F_{\mu\nu} F^{\mu\nu} \rightarrow \bar{\psi} (i\hat{\partial} - e\hat{A} - m) \psi - \frac{1}{4} F_{\mu\nu} F^{\mu\nu} \quad (8.11)$$

giving the interaction term

$$\mathcal{L}_{\text{int}} = -e \bar{\psi} \gamma_\mu \psi A^\mu \quad (8.12)$$

Here the gauge field is coupled to a conserved and gauge invariant current. As a consequence $-j_\mu A^\mu$ is the only interaction term. In fact,

$$\delta\mathcal{L}_{\text{free}} = e \bar{\psi} \gamma_\mu \psi \Lambda^{,\mu} = j_\mu \Lambda^{,\mu} \quad (8.13)$$

and

$$\delta\mathcal{L}_{\text{int}} = -j_\mu \delta A^\mu = -j_\mu \Lambda^{,\mu} \quad (8.14)$$

The canonical quantization for an interacting system follows the same procedure as in the non interacting case. We require canonical commutation and/or anti-commutation relations at equal times for the various fields. For different fields we require equal time vanishing commutation (anticommutation) relations for spin integer (half-integer) fields, whereas we require zero commutation relations among fields of integer spin and fields of half-integer spin. Usually the canonical commutation relations among the fields are not changed by the interactions with respect to the free case. However this is not the case if the interaction term involves derivatives of the fields. This follows from the definition of the canonical momentum densities

$$\Pi^i = \frac{\partial \mathcal{L}}{\partial \dot{\phi}_i} = \frac{\partial \mathcal{L}_{\text{free}}}{\partial \dot{\phi}_i} + \frac{\partial \mathcal{L}_{\text{int}}}{\partial \dot{\phi}_i} \quad (8.15)$$

For instance, for the charged scalar field we get

$$\Pi \equiv \Pi_\phi = \frac{\partial \mathcal{L}}{\partial \dot{\phi}} = \dot{\phi}^\dagger - ie\phi^\dagger A^0, \quad \Pi^\dagger = \Pi_{\phi^\dagger} = \dot{\phi} + ie\phi A^0 \quad (8.16)$$

Since the canonical momenta contain the time component of the gauge field, one can verify that the canonical commutators among the scalar fields and their derivatives are changed by the interaction. Also the propagators are modified. However we will not insist on this point, because in practice it has no consequences on the perturbation theory (see later). When derivative interactions are not present the canonical momentum densities coincide with the free ones, and we get

$$\mathcal{H} = \Pi \dot{\phi} - \mathcal{L} = \Pi \dot{\phi} - \mathcal{L}_{\text{free}} - \mathcal{L}_{\text{int}} = \mathcal{H}_{\text{free}} - \mathcal{L}_{\text{int}} \quad (8.17)$$

and therefore

$$\mathcal{H}_{\text{int}} = -\mathcal{L}_{\text{int}} \quad (8.18)$$

This is what happens for the interaction between a Dirac and the electromagnetic fields. The corresponding theory is called QED (Quantum Electro Dynamics). We recall also that in general the hamiltonian and the electromagnetic current are normal ordered in such a way that the vacuum is an eigenstate of these operators with vanishing eigenvalues. Therefore the interaction term is written as

$$\mathcal{L}_{\text{int}} = -e : \bar{\psi} \gamma_\mu \psi : A^\mu \quad (8.19)$$

We can verify that this is equivalent to write

$$\mathcal{L}_{\text{int}} = -\frac{e}{2} [\bar{\psi}, \gamma_\mu \psi] A^\mu \quad (8.20)$$

For instance, if we consider the electric charge, we get

$$\begin{aligned} Q &= \frac{e}{2} \int d^3x (\psi^\dagger \psi - \gamma_0 \psi \psi^\dagger \gamma_0) \\ &= \frac{e}{2} \sum_{\pm n} \int d^3p \left[b^\dagger(p, n) b(p, n) + d(p, n) d^\dagger(p, n) - b(p, n) b^\dagger(p, n) - d^\dagger(p, n) d(p, n) \right] \\ &= \frac{e}{2} \sum_{\pm n} \int d^3p \left[2b^\dagger(p, n) b(p, n) - 2d^\dagger(p, n) d(p, n) \right. \\ &\quad \left. - [b^\dagger(p, n), b(p, n)]_+ + [d(p, n), d^\dagger(p, n)]_+ \right] =: Q : \end{aligned} \quad (8.21)$$

since the two anticommutators cancel out among themselves.

8.2 The scattering matrix

The scattering processes are a central element in the study of the elementary particles, since they are the only experimental technique available. In the typical scattering process the incoming particles are prepared in a state of definite momentum,

after that the scattering process on some target has taken place, one looks at the final states. In ordinary quantum mechanics this situation is well described by using free wave functions for the initial and final states. This description is certainly correct if one has to do with short-range potentials. In field theory this representation is not really correct, since also in absence of reciprocal interactions the particles have self interactions as we have already noticed. For instance, a real electron can be thought of as if it would have a surrounding cloud of photons which can be emitted and absorbed also when very far from other electrons. A rigorous treatment of these problems is highly non trivial and it is outside of the scopes of this course. Therefore we will confine ourselves to a rather intuitive treatment of the problem. On the other side the imitations of the method will be rather obvious so it may well constitute the basis for a more refined approach. To simplify the matter we will make use of the **adiabatic hypothesis**. This consists in looking at a scattering process in the following way. At time $t = -\infty$ we will suppose that our system can be described in terms of free particles, that is with the interaction turned off. Between $t = -\infty$ and a time $t = -T$, much before the scattering process takes place, we let the coupling describing the interaction grow from zero to its actual value. In the interval $-T < t < +T$, the coupling stays at this value, and then from $t = +T$ and $t = +\infty$ the coupling goes again to zero (see Fig. 8.1)

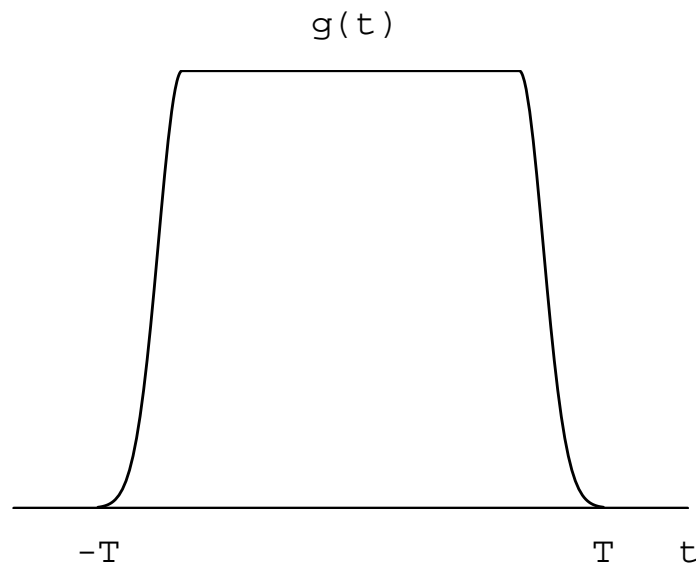

Fig. 8.1 - *The adiabatic switching of the coupling constant.*

In practice this can be realized by defining the interacting part of the hamiltonian as

$$H_{\text{int}}(t, \epsilon) = e^{-\epsilon|t|} H_{\text{int}} \quad (8.22)$$

performing all the calculations and taking the limit $\epsilon \rightarrow 0^+$ at the end. The consistency of this procedure has been shown by various authors and a detailed discussion

can be found, for instance, in the book by Jauch and Rohrlich, Theory of Photons and Electrons.

By using the adiabatic hypothesis we can now discuss the perturbative calculation of the scattering amplitudes. The perturbative expansion will be possible only if the interaction term is small. For instance in QED one gets a series of powers in the fine structure constant $e^2/4\pi \approx 1/137$, therefore, if the coefficients of the expansion do not grow too much, the expansion is justified. Let us start with the equation of motion for the states in the Schrödinger representation

$$i\frac{\partial|\Phi_S(t)\rangle}{\partial t} = H_S|\Phi_S(t)\rangle \quad (8.23)$$

Suppose also that we have two interacting fields A and B . Then we can write

$$H_S = H_S^0 + H_S^I \quad (8.24)$$

with

$$H_S^0 = H_S^0(A) + H_S^0(B) \quad (8.25)$$

and

$$H_S^I \equiv H_S^I(A, B) \quad (8.26)$$

where $H_S^0(A)$ and $H_S^0(B)$ are the free hamiltonians for the fields A and B , and H_S^I is the interaction hamiltonian. It turns out convenient to introduce a new representation for the vectors of state, the interaction representation. This is defined by the following unitary transformation upon the states and on the operators in the Schrödinger representation

$$|\Phi(t)\rangle = e^{iH_S^0 t}|\Phi_S(t)\rangle, \quad O(t) = e^{iH_S^0 t}O_S e^{-iH_S^0 t} \quad (8.27)$$

Of course the matrix elements of any operator in the interaction representation are the same as in the Schrödinger representation

$$\langle\Phi'(t)|O(t)|\Phi(t)\rangle = \langle\Phi'_S(t)|O_S|\Phi_S(t)\rangle \quad (8.28)$$

We have also $H_S^0 = H^0$, where H^0 is the free hamiltonian in the interaction representation. Notice also that the interaction representation coincides with the Heisenberg representation when we switch off the interaction. In the interaction representation the time evolution of the states is dictated by the interaction hamiltonian

$$\begin{aligned} i\frac{\partial|\Phi(t)\rangle}{\partial t} &= i\frac{\partial}{\partial t} \left(e^{iH_S^0 t}|\Phi_S(t)\rangle \right) \\ &= -H_S^0 e^{iH_S^0 t}|\Phi_S(t)\rangle + e^{iH_S^0 t}(H_S^0 + H_S^I)|\Phi_S(t)\rangle \\ &= e^{iH_S^0 t}H_S^I e^{-iH_S^0 t}|\Phi(t)\rangle \end{aligned} \quad (8.29)$$

from which

$$i\frac{\partial|\Phi(t)\rangle}{\partial t} = H^I|\Phi(t)\rangle \quad (8.30)$$

where H^I is the interaction hamiltonian in the interaction representation. On the other side the operators evolve with the free hamiltonian. Therefore, in the interaction representation they coincide with the Heisenberg operators of the non-interacting case.

In order to describe a scattering process we will assign to the vector of state a condition at $t = -\infty$

$$|\Phi(-\infty)\rangle \equiv |\Phi_i\rangle \quad (8.31)$$

where the state Φ_i will be specified by assigning the set of incoming free particles in terms of eigenstates of momentum, spin and so on. For instance, in QED we will have to specify how many electrons, positrons and photons are in the initial state and we will have to specify their momenta, the spin projection of fermions and the polarization of the photons. The equations of motion will tell us how this state evolves with time and it will be possible to evaluate the state at $t = +\infty$, where, ideally, we will detect the final states. In practice the preparation and the detection processes are made at some finite times. It follows that our ideal description will be correct only if these times are much bigger than the typical interaction time of the scattering process. Once we know $\Phi(+\infty)$, we are interested to evaluate the probability amplitude of detecting at $t = +\infty$ a given set of free particles (see the adiabatic hypothesis) specified by a vector state Φ_f . This amplitude is

$$S_{fi} = \langle \Phi_f | \Phi(+\infty) \rangle \quad (8.32)$$

We will define the S matrix as the operator that give us $|\Phi(+\infty)\rangle$ once we know $|\Phi(-\infty)\rangle$

$$|\Phi(+\infty)\rangle = S |\Phi(-\infty)\rangle \quad (8.33)$$

The amplitude S_{fi} is then

$$S_{fi} = \langle \Phi_f | S | \Phi_i \rangle \quad (8.34)$$

Therefore S_{fi} is the S matrix element between free states. To evaluate the S matrix we first transform the Schrödinger equation in the interaction representation in an integral equation

$$|\Phi(t)\rangle = |\Phi(-\infty)\rangle - i \int_{-\infty}^t dt_1 H^I(t_1) |\Phi(t_1)\rangle \quad (8.35)$$

One can verify that this indeed a solution, and furthermore it satisfies explicitly the boundary condition at $t = -\infty$. The perturbative expansion consists in evaluating $|\Phi(t)\rangle$ by iterating this integral equation

$$|\Phi(t)\rangle = |\Phi(-\infty)\rangle - i \int_{-\infty}^t dt_1 H^I(t_1) \left[|\Phi(-\infty)\rangle - i \int_{-\infty}^{t_1} dt_2 H^I(t_2) |\Phi(t_2)\rangle \right] \quad (8.36)$$

Continuing the iteration we get

$$\begin{aligned} |\Phi(t)\rangle = & \left[1 - i \int_{-\infty}^t dt_1 H^I(t_1) + (-i)^2 \int_{-\infty}^t dt_1 \int_{-\infty}^{t_1} dt_2 H^I(t_1) H^I(t_2) \right. \\ & \left. + \dots \right] |\Phi(-\infty)\rangle \end{aligned} \quad (8.37)$$

Of course this is meaningful only if the expansion is a convergent one. By taking the limit for $t = +\infty$ we get the perturbative expansion of the S matrix

$$S = 1 + \sum_{n=1}^{\infty} (-i)^n \int_{-\infty}^{+\infty} dt_1 \int_{-\infty}^{t_1} dt_2 \cdots \int_{-\infty}^{t_{n-1}} dt_n [H^I(t_1)H^I(t_2)\cdots H^I(t_n)] \quad (8.38)$$

We can rewrite this expression in terms of T -products

$$S = 1 + \sum_{n=1}^{\infty} \frac{(-i)^n}{n!} \int_{-\infty}^{+\infty} dt_1 \cdots \int_{-\infty}^{+\infty} dt_n T(H^I(t_1)\cdots H^I(t_n)) \quad (8.39)$$

The T -product of n terms means that the factors have to be written from left to right with decreasing times. For instance, if $t_1 \geq t_2 \geq \cdots \geq t_n$, then

$$T(H^I(t_1)\cdots H^I(t_n)) = H^I(t_1)\cdots H^I(t_n) \quad (8.40)$$

The equality of the two expressions (8.38) and (8.39) holds term by term. As an example, consider $n = 2$. The term in eq. (8.39) can be written as

$$\begin{aligned} A &= \int_{t_1}^{t_2} \int_{t_1}^{t_2} dt ds T(H^I(t)H^I(s)) \\ &= \int_{t_1}^{t_2} dt H^I(t) \left(\int_{t_1}^t ds H^I(s) \right) + \int_{t_1}^{t_2} dt \left(\int_t^{t_2} ds H^I(s) \right) H^I(t) \end{aligned} \quad (8.41)$$

By looking at Figs. 8.2 and 8.3 one sees easily that exchanging the integrations on s and t one gets

$$\int_{t_1}^{t_2} dt \int_t^{t_2} ds = \int_{t_1}^{t_2} ds \int_{t_1}^s dt \quad (8.42)$$

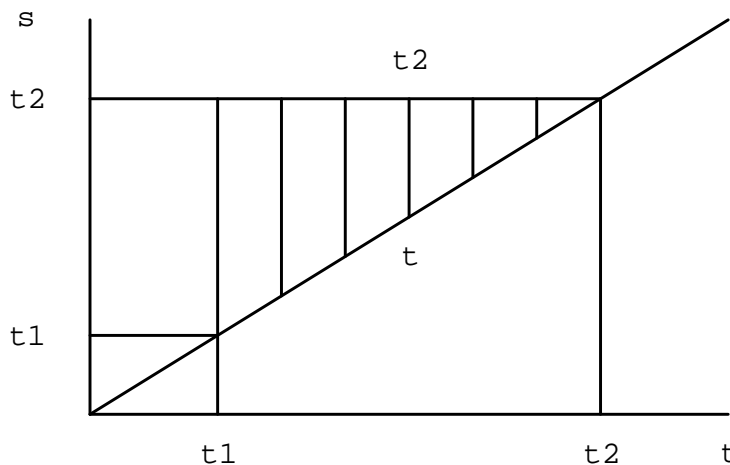

Fig. 8.2 - The figure represents schematically the integral $\int_{t_1}^{t_2} dt \int_t^{t_2} ds$.

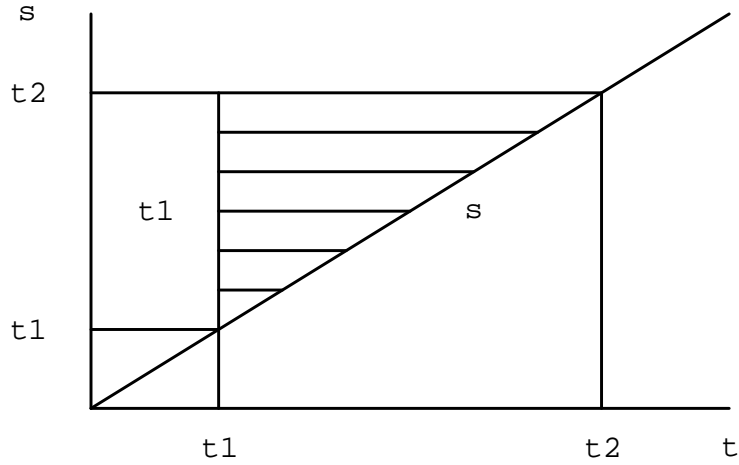

Fig. 8.3 - The figure represents schematically the integral $\int_{t_1}^{t_2} ds \int_{t_1}^s dt$.

Therefore

$$A = \int_{t_1}^{t_2} dt \int_{t_1}^t ds H^I(t)H^I(s) + \int_{t_1}^{t_2} ds \int_{t_1}^s dt H^I(s)H^I(t) \quad (8.43)$$

and exchanging $s \leftrightarrow t$ in the second integral

$$A = 2 \int_{t_1}^{t_2} dt \int_{t_1}^t ds H^I(t)H^I(s) \quad (8.44)$$

The result for the n^{th} term in the series can be obtained in a completely analogous way.

Since the S matrix connects the set of free states at $t = -\infty$ with a set of free states at $t = +\infty$, it should represent simply a change of basis and as such it should be unitary. From this point of view the unitarity property of the S matrix is a very fundamental one because it has to do with the very fundamental properties of quantum mechanics. So it is important to check that at least formally (this refers to the fact that we don't really know if the series which we have found for the S matrix is a convergent one) the expression (8.39) represents a unitary operator. In order to do that we start rewriting S in the form

$$S = T\left(e^{-i \int_{-\infty}^{+\infty} dt H^I(t)}\right) \quad (8.45)$$

This expression is a symbolic one and it is really defined by its series expansion

$$S = \sum_{n=0}^{\infty} \frac{(-i)^n}{n!} T\left(\int_{-\infty}^{+\infty} dt H^I(t)\right)^n = \sum_{n=0}^{\infty} \frac{(-i)^n}{n!} \int_{-\infty}^{+\infty} dt_1 \cdots dt_n T\left(H^I(t_1) \cdots H^I(t_n)\right) \quad (8.46)$$

The motivation for introducing the T -ordered exponential is that it satisfies the following factorization property

$$T\left(e^{\int_{t_1}^{t_3} O(t)dt}\right) = T\left(e^{\int_{t_2}^{t_3} O(t)dt}\right)T\left(e^{\int_{t_1}^{t_2} O(t)dt}\right) \quad (8.47)$$

To prove this relation we first consider the following expression ($t_1 \leq t_2 \leq t_3$)

$$\begin{aligned} T\left(\int_{t_1}^{t_3} O(t)dt\right)^n &= \int_{t_1}^{t_3} \cdots \int_{t_1}^{t_3} ds_1 \cdots ds_n T(O(s_1) \cdots O(s_n)) \\ &= \left(\int_{t_2}^{t_3} + \int_{t_1}^{t_2}\right) \left(\int_{t_2}^{t_3} + \int_{t_1}^{t_2}\right) \cdots \left(\int_{t_2}^{t_3} + \int_{t_1}^{t_2}\right) ds_1 \cdots ds_n T(O(s_1) \cdots O(s_n)) \\ &= \sum_{k=0}^n \frac{n!}{(n-k)!k!} \int_{t_2}^{t_3} \cdots \int_{t_2}^{t_3} ds_1 \cdots ds_{n-k} \\ &\quad \times \int_{t_1}^{t_2} \cdots \int_{t_1}^{t_2} dz_1 \cdots dz_k T(O(s_1) \cdots O(s_{n-k})O(z_1) \cdots O(z_k)) \\ &= \sum_{k=0}^n \frac{n!}{(n-k)!k!} \int_{t_2}^{t_3} \cdots \int_{t_2}^{t_3} ds_1 \cdots ds_{n-k} T(O(s_1) \cdots O(s_{n-k})) \\ &\quad \times \int_{t_1}^{t_2} \cdots \int_{t_1}^{t_2} dz_1 \cdots dz_k T(O(z_1) \cdots O(z_k)) \end{aligned} \quad (8.48)$$

In the last term we have used the fact that all the times z_i are smaller than the times s_i . What we have proved is the relation

$$T\left(\int_{t_1}^{t_3} dt O(t)\right)^n = \sum_{k=0}^n \frac{n!}{(n-k)!k!} T\left(\int_{t_2}^{t_3} dt O(t)\right)^{n-k} T\left(\int_{t_1}^{t_2} dt O(t)\right)^k \quad (8.49)$$

The factorization property (8.47) follows immediately if we remember that the analogous property for the ordinary exponential

$$e^{a+b} = e^a e^b \quad (8.50)$$

just follows from the binomial expansion

$$e^{a+b} = \sum_{n=0}^{\infty} \frac{1}{n!} (a+b)^n = \sum_{n=0}^{\infty} \frac{1}{n!} \sum_{k=0}^n \frac{n!}{(n-k)!k!} a^{n-k} b^k \quad (8.51)$$

using

$$\sum_{n=0}^{\infty} \sum_{k=0}^n = \sum_{k=0}^{\infty} \sum_{n=k}^{\infty} \quad (8.52)$$

and putting $h = n - k$. Since eq. (8.49) generalizes the binomial formula to T -products of powers of time integrals of operators, by the same token we get the formula (8.47). With this property we can now prove the unitarity of any operator of the form

$$U = T\left(e^{-i \int_{t_i}^{t_f} dt O(t)}\right) \quad (8.53)$$

with $O(t)$ a hermitian operator. To this end let us divide the time interval (t_i, t_f) in N infinitesimal intervals Δt with

$$t_i \equiv t_1 \leq t_2 \leq \dots \leq t_N = t_f \quad (8.54)$$

then we can write

$$U = \lim_{N \rightarrow \infty} e^{-i\Delta t O(t_N)} e^{-i\Delta t O(t_{N-1})} \dots e^{-i\Delta t O(t_1)} \quad (8.55)$$

from which

$$U^\dagger = \lim_{N \rightarrow \infty} e^{+i\Delta t O(t_1)} e^{+i\Delta t O(t_2)} \dots e^{+i\Delta t O(t_N)} \quad (8.56)$$

and the unitarity follows immediately.

Let us notice that if there are no derivative interactions we have

$$S = T \left(e^{-i \int_{-\infty}^{+\infty} dt H^I(t)} \right) = T \left(e^{+i \int d^4x \mathcal{L}_{\text{int}}} \right) \quad (8.57)$$

It follows that if the theory is Lorentz invariant, also the S matrix enjoys the same property. One could think that for theories with derivative interactions the Lorentz invariance is lost. However it is possible to show that also in these theories the S matrix is given by the same equation. To see that the S matrix is Lorentz invariant, notice that the statement would be trivial but for the presence of the T -product. However this is invariant under proper Lorentz transformations for time-like separations (remember that a proper Lorentz transformation cannot change the sign of the time component of a four-vector). In the case of space-like separations consider, for instance, the second order term in the series for S

$$\int d^4x_1 d^4x_2 \left[\theta(x_1^0 - x_2^0) \mathcal{L}_{\text{int}}(x_1) \mathcal{L}_{\text{int}}(x_2) + \theta(x_2^0 - x_1^0) \mathcal{L}_{\text{int}}(x_2) \mathcal{L}_{\text{int}}(x_1) \right] \quad (8.58)$$

Since we integrate over x_1 and x_2 , the separation between the two points can be either space-like either time-like. However, if the lagrangian density is a local function of the fields, it follows that

$$[\mathcal{L}_{\text{int}}(x_1), \mathcal{L}_{\text{int}}(x_2)] = 0 \quad \text{per} \quad (x_1 - x_2)^2 < 0 \quad (8.59)$$

and therefore for $(x_1 - x_2)^2 < 0$ we get

$$T(\mathcal{L}_{\text{int}}(x_1) \mathcal{L}_{\text{int}}(x_2)) = \mathcal{L}_{\text{int}}(x_1) \mathcal{L}_{\text{int}}(x_2) \quad (8.60)$$

This shows that the T -product of local invariant Lorentz operators is Lorentz invariant. We had an example of this property when we evaluated the propagator for a scalar field.

8.3 The Wick's theorem

In the previous Section we have shown that the S matrix can be evaluated in terms of matrix elements of T -products. As we shall see in the applications, the matrix elements of the S matrix between free particle states can in turn be expressed as vacuum expectation values (VEV's) of T -products. These VEV's satisfy an important theorem due to Wick that states that the T -products of an arbitrary number of free fields (the ones we have to do in the interaction representation) can be expressed as combinations of T -products among two fields, that is in terms of Feynman propagators. In order to prove the theorem we will use the technique of generating functionals. That is we will start by proving the following identity

$$\begin{aligned} T\left(e^{-i \int d^4x j(x)\phi(x)}\right) \\ =: e^{-i \int d^4x j(x)\phi(x)} : e^{-\frac{1}{2} \int d^4x d^4y j(x)j(y)\langle 0|T(\phi(x)\phi(y))|0\rangle} \end{aligned} \quad (8.61)$$

where $\phi(x)$ is a free real scalar field and $j(x)$ an ordinary real function. The previous formula can be easily extended to charged scalar, fermionic and photon fields. The Wick's theorem is then obtained by expanding both sides of this equation in powers of $j(x)$ and taking the VEV of both sides. Let us start by expanding the left hand side of the formula, by using the factorization property in eq. (8.47). Let us also define

$$O(t) = \int d^3x j(x)\phi(x) \quad (8.62)$$

and notice that for free fields $[O(t), O(t')]$ is just an ordinary number (called a c -number, to be contrasted with operators which are called q -numbers). Dividing again the interval (t_i, t_f) in N pieces of amplitude Δt as in the previous Section, we get

$$T\left(e^{-i \int_{t_i}^{t_f} dt O(t)}\right) = \lim_{N \rightarrow \infty} e^{-i\Delta t O(t_N)} e^{-i\Delta t O(t_{N-1})} \dots e^{-i\Delta t O(t_1)} \quad (8.63)$$

and using

$$e^A e^B = e^{A+B} e^{\frac{1}{2}[A, B]} \quad (8.64)$$

valid if $[A, B]$ commutes con A e B , we get

$$\begin{aligned} T\left(e^{-i \int_{t_i}^{t_f} dt O(t)}\right) \\ = \lim_{N \rightarrow \infty} \prod_{i=3}^N e^{-i\Delta t O(t_i)} e^{-i\Delta t (O(t_2) + O(t_1))} e^{-\frac{1}{2}\Delta t^2 [O(t_2), O(t_1)]} \end{aligned}$$

$$\begin{aligned}
&= \lim_{N \rightarrow \infty} \prod_{i=4}^N e^{-i\Delta t O(t_i)} e^{-i\Delta t (O(t_3) + O(t_2) + O(t_1))} \\
&\times e^{-\frac{1}{2}\Delta t^2 [O(t_3), O(t_2) + O(t_1)] - \frac{1}{2}\Delta t^2 [O(t_2), O(t_1)]} \\
&= \lim_{N \rightarrow \infty} e^{-i\Delta t \sum_{i=1}^N O(t_i)} e^{-\frac{1}{2}\Delta t^2 \sum_{1 \leq i \leq j \leq N} [O(t_j), O(t_i)]} \\
&= e^{-i \int_{t_i}^{t_f} dt O(t)} e^{-\frac{1}{2} \int_{t_i}^{t_f} dt_1 dt_2 \theta(t_1 - t_2) [O(t_1), O(t_2)]} \tag{8.65}
\end{aligned}$$

from which

$$\begin{aligned}
&T \left(e^{-i \int d^4x j(x)\phi(x)} \right) \\
&= e^{-i \int d^4x j(x)\phi(x)} e^{-\frac{1}{2} \int d^4x d^4y j(x)j(y)\theta(x_0 - y_0) [\phi(x), \phi(y)]} \tag{8.66}
\end{aligned}$$

The next step is to expand the first exponential on the right hand side of this equation in normal products. We have

$$\begin{aligned}
e^{-i \int d^4x j(x)\phi(x)} &= e^{-i \int d^4x j(x)(\phi^{(+)}(x) + \phi^{(-)}(x))} \\
&= e^{-i \int d^4x j(x)\phi^{(-)}(x)} e^{-i \int d^4x j(x)\phi^{(+)}(x)} \\
&\times e^{+\frac{1}{2} \int d^4x d^4y j(x)j(y) [\phi^{(-)}(x), \phi^{(+)}(y)]} \tag{8.67}
\end{aligned}$$

where we have used again the equation (8.64). Therefore

$$\begin{aligned}
e^{-i \int d^4x j(x)\phi(x)} &= : e^{-i \int d^4x j(x)\phi(x)} : \\
&\times e^{+\frac{1}{2} \int d^4x d^4y j(x)j(y) [(\phi(x)^{-}), \phi^{(+)}(y)]} \tag{8.68}
\end{aligned}$$

Substituting in eq. (8.66)

$$\begin{aligned}
T \left(e^{-i \int d^4x j(x)\phi(x)} \right) &=: e^{-i \int d^4x j(x)\phi(x)} : \\
&\times e^{+\frac{1}{2} \int d^4x d^4y j(x)j(y) ([\phi^{(-)}(x), \phi^{(+)}(y)] - \theta(x_0 - y_0) [\phi(x), \phi(y)])} \tag{8.69}
\end{aligned}$$

The argument of the second exponential is a c -number because it proportional to commutators of free fields, and therefore we can evaluate it just by taking its VEV

$$\begin{aligned}
A &\equiv [\phi^{(-)}(x), \phi^{(+)}(y)] - \theta(x_0 - y_0) [\phi(x), \phi(y)] \\
&= \langle 0 | [\phi^{(-)}(x), \phi^{(+)}(y)] - \theta(x_0 - y_0) [\phi(x), \phi(y)] | 0 \rangle \tag{8.70}
\end{aligned}$$

Since $\phi^{(+)}|0\rangle = 0$, we can write

$$\begin{aligned} A &= -\langle 0 | [\phi(y)\phi(x) + \theta(x_0 - y_0)\phi(x)\phi(y) - \theta(x_0 - y_0)\phi(y)\phi(x)] | 0 \rangle \\ &= -\langle 0 | [\theta(y_0 - x_0)\phi(y)\phi(x) + \theta(x_0 - y_0)\phi(x)\phi(y)] | 0 \rangle \\ &= -\langle 0 | T(\phi(x)\phi(y)) | 0 \rangle \end{aligned} \quad (8.71)$$

This proves our identity (8.61). Let us now expand both sides of eq. (8.61) in a series of $j(x)$ and compare term by term. We will use the simplified notation $\phi_i \equiv \phi(x_i)$. We get

$$T(\phi) = : \phi : \quad (8.72)$$

$$T(\phi_1\phi_2) = : \phi_1\phi_2 : + \langle 0 | T(\phi_1\phi_2) | 0 \rangle \quad (8.73)$$

$$T(\phi_1\phi_2\phi_3) = : \phi_1\phi_2\phi_3 : + \sum_{i \neq j \neq k=1}^3 : \phi_i : \langle 0 | T(\phi_j\phi_k) | 0 \rangle \quad (8.74)$$

$$\begin{aligned} T(\phi_1\phi_2\phi_3\phi_4) &= : \phi_1\phi_2\phi_3\phi_4 : + \sum_{i \neq j \neq k \neq l=1}^4 \left[: \phi_i\phi_j : \langle 0 | T(\phi_k\phi_l) | 0 \rangle \right. \\ &\quad \left. + \langle 0 | T(\phi_i\phi_j) | 0 \rangle \langle 0 | T(\phi_k\phi_l) | 0 \rangle \right] \end{aligned} \quad (8.75)$$

and so on. By taking the VEV of these expression, and recalling that the VEV of a normal product is zero, we get the Wick's theorem. The T -product of two field operators is sometimes called the **contraction** of the two operators. Therefore to evaluate the VEV of a T -product of an arbitrary number of free fields, it is enough to consider all the possible contractions of the fields appearing in the T -product. For instance, from the last of the previous relations we get

$$\langle 0 | T(\phi_1\phi_2\phi_3\phi_4) | 0 \rangle = \sum_{i \neq j \neq k \neq l=1}^4 \langle 0 | T(\phi_i\phi_j) | 0 \rangle \langle 0 | T(\phi_k\phi_l) | 0 \rangle \quad (8.76)$$

An analogous theorem holds for the photon field. For the fermions one has to remember that the T -product is defined in a slightly different way. This gives a minus sign any time we have a permutation of the fermion fields which is odd with respect to the original ordering. As an illustration the previous formula becomes

$$\langle 0 | T(\psi_1\psi_2\psi_3\psi_4) | 0 \rangle = \sum_{i \neq j \neq k \neq l=1}^4 \sigma_P \langle 0 | T(\psi_i\psi_j) | 0 \rangle \langle 0 | T(\psi_k\psi_l) | 0 \rangle \quad (8.77)$$

where $\sigma_P = \pm 1$ is the sign of the permutation (i, j, k, l) with respect to the fundamental one $(1, 2, 3, 4)$ appearing on the right hand side. More explicitly

$$\begin{aligned} \langle 0 | T(\psi_1\psi_2\psi_3\psi_4) | 0 \rangle &= \langle 0 | T(\psi_1\psi_2) | 0 \rangle \langle 0 | T(\psi_3\psi_4) | 0 \rangle \\ &\quad - \langle 0 | T(\psi_1\psi_3) | 0 \rangle \langle 0 | T(\psi_2\psi_4) | 0 \rangle \\ &\quad + \langle 0 | T(\psi_1\psi_4) | 0 \rangle \langle 0 | T(\psi_2\psi_3) | 0 \rangle \end{aligned} \quad (8.78)$$

8.4 Evaluation of the S matrix at second order in QED

In the case of QED the S matrix is given by

$$S = 1 + \sum_{n=1}^{\infty} \frac{(+i)^n}{n!} \int \cdots \int d^4x_1 \cdots d^4x_n T(\mathcal{L}_I(x_1) \cdots \mathcal{L}_I(x_n)) \quad (8.79)$$

with (see eq. (8.19))

$$\mathcal{L}_I = -e : \bar{\psi} \hat{A} \psi : \quad (8.80)$$

We have now to understand how to use the Wick's theorem in the actual situation. Consider, for simplicity, two scalar fields. From eq. (8.73) we get (at equal times the T -product and the usual product coincides)

$$\phi_a(x)\phi_b(x) =: \phi_a(x)\phi_b(x) : + \langle 0|T(\phi_a(x)\phi_b(x))|0\rangle \quad (8.81)$$

from which

$$: \phi_a(x)\phi_b(x) := \phi_a(x)\phi_b(x) - \langle 0|T(\phi_a(x)\phi_b(x))|0\rangle \quad (8.82)$$

Therefore

$$\begin{aligned} T(: \phi_a(x)\phi_b(x) : \phi_1(x_1) \cdots \phi_n(x_n)) &= T(\phi_a(x)\phi_b(x)\phi_1(x_1) \cdots \phi_n(x_n)) \\ &- \langle 0|T(\phi_a(x)\phi_b(x))|0\rangle T(\phi_1(x_1) \cdots \phi_n(x_n)) \end{aligned} \quad (8.83)$$

Since the second term subtracts the contraction between the two operators taken at the same point, we can generalize the Wick expansion by saying that when normal product are contained inside a T -product the Wick's expansion applies with the further rule that the contractions of operators at the same point, inside the normal product, are vanishing. With this convention we can write

$$T(: A(x_1)B(x_1) \cdots : \cdots : A(x_n)B(x_n) \cdots :) = T(A(x_1)B(x_1) \cdots A(x_n)B(x_n) \cdots) \quad (8.84)$$

In the case of QED one can get convinced more easily by recalling that

$$: \bar{\psi} \gamma_\mu \psi := \frac{1}{2} [\bar{\psi}, \gamma_\mu \psi] \quad (8.85)$$

and noticing that inside a T -product the fields can be freely commuted except for taking into account of their statistics. For instance

$$T(: \bar{\psi} \gamma_\mu \psi :) = \frac{1}{2} T([\bar{\psi}, \gamma_\mu \psi]) = T(\bar{\psi} \gamma_\mu \psi) \quad (8.86)$$

For the following analysis it is useful to remember how the various field operators act on the kets

ψ^+	annihilates	e^-	ψ^-	creates	e^+	
$\bar{\psi}^+$	annihilates	e^+	$\bar{\psi}^-$	creates	e^-	
A^+	annihilates	γ	A^-	creates	γ	(8.87)

Decomposing \mathcal{L}_I in positive and negative frequency components

$$\mathcal{L}_I = -e : (\bar{\psi}^+ + \bar{\psi}^-)(A_\mu^+ + A_\mu^-)\gamma^\mu(\psi^+ + \psi^-) : \quad (8.88)$$

we get 8 terms with non vanishing matrix elements. For instance

$$: \bar{\psi}_\alpha^+ \hat{A}_{\alpha\beta}^- \psi_\beta^- := -\psi_\beta^- \hat{A}_{\alpha\beta}^- \bar{\psi}_\alpha^+ \quad (8.89)$$

has the following non vanishing matrix element

$$\langle e^+ \gamma | \psi^- \hat{A}^- \bar{\psi}^+ | e^+ \rangle \quad (8.90)$$

This process corresponds to a positron emitting a photon. This and the other seven processes described by the S matrix at the first order

$$S^{(1)} = -ie \int d^4x : \bar{\psi}(x) \hat{A}(x) \psi(x) : \quad (8.91)$$

are represented by the diagrams of Figs. 8.4 and 8.5.

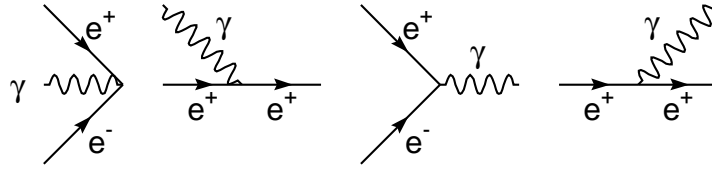

Fig. 8.4 -Diagrams for the processes described by the S matrix at the first order.

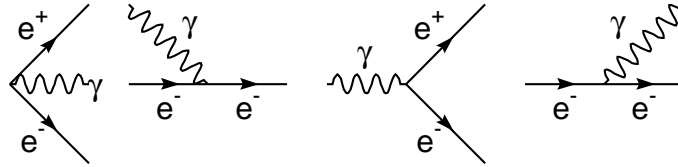

Fig. 8.5 -Diagrams for the processes described by the S matrix at the first order.

However none of these contributions corresponds to a physically possible process since the four momentum is not conserved. We will show later that the conservation of the four momentum is a consequence of the theory. For the moment we will assume it and we will show that for real particles (that is for particles on the mass shell $p^2 = m^2$) these processes cannot happen. For instance consider

$$e^-(p) \rightarrow e^-(p') + \gamma(k) \quad (8.92)$$

if the four momentum is conserved

$$p = p' + k \quad (8.93)$$

from which

$$m^2 = m^2 - 2p \cdot k \quad (8.94)$$

where we have used $k^2 = 0$ for the photon. In the rest frame of the electron we get $mk_0 = 0$. Therefore the process is possible only for a photon with vanishing four momentum. Let us now consider the 2^0 order contribution

$$S^{(2)} = \frac{(-ie)^2}{2!} \int d^4x_1 d^4x_2 T \left(\bar{\psi}(x_1) \hat{A}(x_1) \psi(x_1) \bar{\psi}(x_2) \hat{A}(x_2) \psi(x_2) \right) \quad (8.95)$$

We can expand $S^{(2)}$ with the Wick's theorem, and classify the various contributions according to the number of contractions. If we associate to a contraction of two fields at the points x_1 and x_2 a line, we see that the terms originating from $S^{(2)}$ can be obtained by connecting among them the diagrams depicted in Figs. 8.4 and 8.5 in all the possible ways. In this case the only non vanishing contractions are the ones between ψ and $\bar{\psi}$, and between A_μ and A_ν . Recalling from Section 7.1

$$\begin{aligned} \langle 0 | T(\psi_\alpha(x) \bar{\psi}_\beta(y)) | 0 \rangle &= iS_F(x-y)_{\alpha\beta} \\ \langle 0 | T(A_\mu(x) A_\nu(y)) | 0 \rangle &= ig_{\mu\nu} D(x-y) \end{aligned} \quad (8.96)$$

we get

$$S^{(2)} = \sum_{i=1}^6 S_i^{(2)} \quad (8.97)$$

where

$$S_1^{(2)} = \frac{(-ie)^2}{2!} \int d^4x_1 d^4x_2 : \bar{\psi}(x_1) \hat{A}(x_1) \psi(x_1) \bar{\psi}(x_2) \hat{A}(x_2) \psi(x_2) : \quad (8.98)$$

$$\begin{aligned} S_2^{(2)} &= \frac{(-ie)^2}{2!} \int d^4x_1 d^4x_2 : \bar{\psi}(x_1) \hat{A}(x_1) iS_F(x_1-x_2) \hat{A}(x_2) \psi(x_2) : \\ &+ \frac{(-ie)^2}{2!} \int d^4x_1 d^4x_2 : \bar{\psi}(x_2) \hat{A}(x_2) iS_F(x_2-x_1) \hat{A}(x_1) \psi(x_1) : \\ &= (-ie)^2 \int d^4x_1 d^4x_2 : \bar{\psi}(x_1) \hat{A}(x_1) iS_F(x_1-x_2) \hat{A}(x_2) \psi(x_2) : \end{aligned} \quad (8.99)$$

$$S_3^{(2)} = \frac{(-ie)^2}{2!} \int d^4x_1 d^4x_2 : \bar{\psi}(x_1) \gamma_\mu \psi(x_1) ig^{\mu\nu} D(x_1-x_2) \bar{\psi}(x_2) \gamma_\nu \psi(x_2) : \quad (8.100)$$

$$\begin{aligned} S_4^{(2)} &= \frac{(-ie)^2}{2!} \int d^4x_1 d^4x_2 : \bar{\psi}(x_1) \gamma_\mu iS_F(x_1-x_2) ig^{\mu\nu} D(x_1-x_2) \gamma_\nu \psi(x_2) : \\ &+ \frac{(-ie)^2}{2!} \int d^4x_1 d^4x_2 : \bar{\psi}(x_2) \gamma_\mu iS_F(x_2-x_1) ig^{\mu\nu} D(x_2-x_1) \gamma_\nu \psi(x_1) : \\ &= (-ie)^2 \int d^4x_1 d^4x_2 : \bar{\psi}(x_1) \gamma_\mu iS_F(x_1-x_2) ig^{\mu\nu} D(x_1-x_2) \gamma_\nu \psi(x_2) : \end{aligned} \quad (8.101)$$

$$S_5^{(2)} = \frac{(-ie)^2}{2!} \int d^4x_1 d^4x_2 (-1) : Tr[iS_F(x_1-x_2)\hat{A}(x_2)iS_F(x_2-x_1)\hat{A}(x_1)] : \quad (8.102)$$

$$S_6^{(2)} = \frac{(-ie)^2}{2!} \int d^4x_1 d^4x_2 (-1) : Tr[iS_F(x_1-x_2)\gamma_\mu iS_F(x_2-x_1)\gamma_\nu ig^{\mu\nu}D(x_2-x_1)] : \quad (8.103)$$

The term $S_1^{(2)}$ is nothing but the product of two processes of type $S^{(1)}$ and it does not give rise to real processes. The term $S_2^{(2)}$ is obtained by contracting a two fermionic fields, and this means to connect with a fermionic line two of the vertices of Figs. 8.4 and 8.5. The possible external particles are two γ , two e^- , two e^+ , or a pair e^+e^- . Selecting the external states we can get different physical processes. One of these processes is the Compton scattering $\gamma + e^- \rightarrow \gamma + e^-$. In this case we must select in $S_2^{(2)}$ $\psi^+(x_2)$ to destroy the initial electron and $\bar{\psi}^-$ to create the final electron. As for the photons are concerned, since A_μ is a real field, we can destroy the initial photon both in x_2 and x_1 and create the final photon in the other point. Therefore we get two contributions

$$S_2^{(2)}(\gamma e^- \rightarrow \gamma e^-) = S_a + S_b \quad (8.104)$$

with

$$S_a = (-ie)^2 \int d^4x_1 d^4x_2 \bar{\psi}^-(x_1)\gamma^\mu iS_F(x_1-x_2)\gamma^\nu A_\mu^-(x_1)A_\nu^+(x_2)\psi^+(x_2) \quad (8.105)$$

and

$$S_b = (-ie)^2 \int d^4x_1 d^4x_2 \bar{\psi}^-(x_1)\gamma^\mu iS_F(x_1-x_2)\gamma^\nu A_\nu^-(x_2)A_\mu^+(x_1)\psi^+(x_2) \quad (8.106)$$

The corresponding diagrams are given in Fig. 8.6

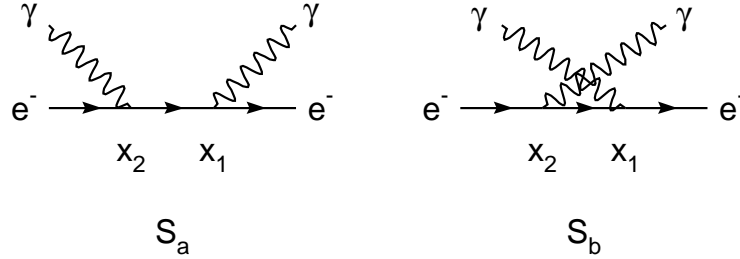

Fig. 8.6 -Diagrams for the Compton scattering.

The terms corresponding to the Compton scattering for a positron are obtained from the previous ones by substituting ψ^+ (annihilates an electron) with ψ^- (creates a positron) and $\bar{\psi}^-$ (creates an electron) with $\bar{\psi}^+$ (annihilates a positron). The other two processes coming from $S_2^{(2)}$ are $2\gamma \rightarrow e^+e^-$ (pair creation) and $e^+e^- \rightarrow 2\gamma$ (pair annihilation). The S matrix element for the pair creation is given by

$$S_2^{(2)}(2\gamma \rightarrow e^+e^-) = (-ie)^2 \int d^4x_1 d^4x_2 \bar{\psi}^-(x_1)\gamma^\mu iS_F(x_1-x_2)\gamma^\nu A_\mu^+(x_1)A_\nu^+(x_2)\psi^-(x_2) \quad (8.107)$$

Notice that in evaluating

$$A_\mu^+(x_1)A_\nu^+(x_2)|\gamma(k_1)\gamma(k_2)\rangle \quad (8.108)$$

we get two contributions since one of the fields A_μ^+ can annihilate any one of the two external photons. The diagrams for these two contributions are given in Fig. 8.7.

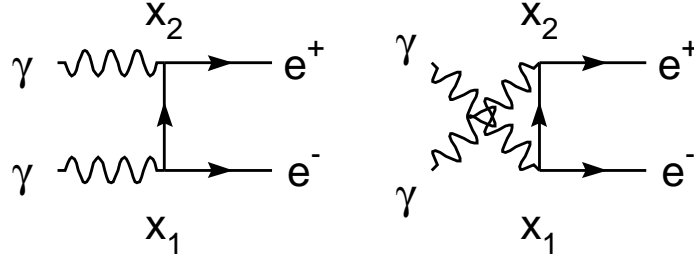

Fig. 8.7 -Diagrams for the pair creation.

We have analogous contributions and diagrams for the pair annihilation process.

The next processes we consider are the ones generated by $S_3^{(2)}$ in which we have contacted the photon fields. They are: electron scattering $e^-e^- \rightarrow e^-e^-$, positron scattering e^+e^+ and $e^+e^- \rightarrow e^+e^-$. For the electron scattering we have

$$S_3^{(2)}(2e^- \rightarrow 2e^-) = \frac{(-ie)^2}{2!} \int d^4x_1 d^4x_2 : \bar{\psi}^-(x_1)\gamma_\mu\psi^+(x_1)ig^{\mu\nu}D(x_1-x_2)\bar{\psi}^-(x_2)\gamma_\nu\psi^+(x_2) : \quad (8.109)$$

The term

$$\psi^+(x_1)\psi^+(x_2)|e^-(p_1)e^-(p_2)\rangle \quad (8.110)$$

gives rise to two contributions, and other two come from the final state. The corresponding diagrams are given in Fig. 8.8.

The terms a) and d) differ only for the exchange $x_1 \leftrightarrow x_2$ and therefore they are equal after having exchanged the integration variables. The same is true for the terms b) and c). In this way we get a factor 2 which cancels the 2! in the denominator. This the same phenomenon as for the term $S_2^{(2)}$. That is there diagrams giving rise to the same contribution to the scattering amplitude. At the order n on has $n!$ equivalent diagrams which cancel the factor $n!$ coming from the expansion of the S matrix. This means that it is enough to draw all the inequivalent diagrams. For the electron scattering we have two such diagrams differing for a minus sign due to the exchange of the fermionic lines. This reflects the fact that field theory takes automatically into account the statistics of the particles. In the present case by giving rise to a properly antisymmetrized amplitude.

For the process $e^+e^- \rightarrow e^+e^-$ we get the diagrams the diagrams of Fig. 8.9. The inequivalent diagrams are those of Fig. 8.10 and correspond to the following contributions

$$S_3^{(2)}(e^+e^- \rightarrow e^+e^-) = S_a(e^+e^- \rightarrow e^+e^-) + S_b(e^+e^- \rightarrow e^+e^-) \quad (8.111)$$

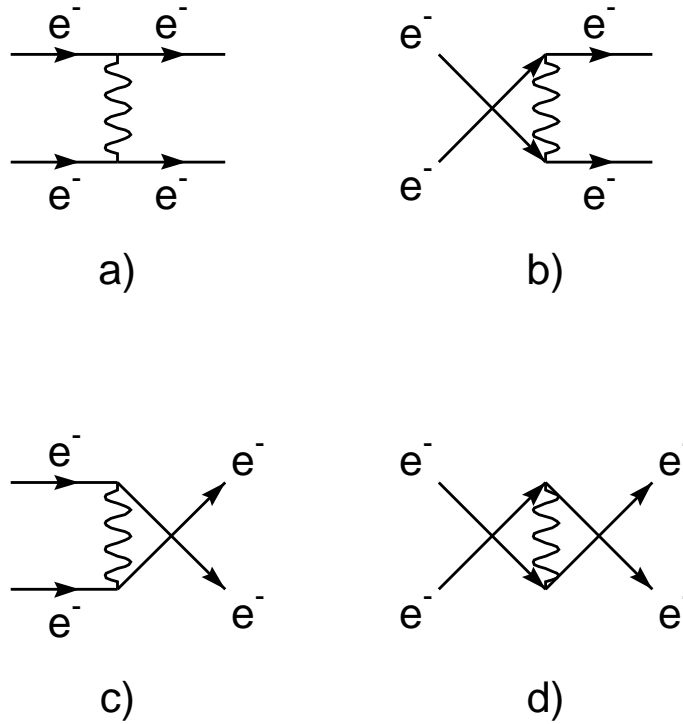

Fig. 8.8 -Diagrams for electron scattering.

with

$$S_a(e^+e^- \rightarrow e^+e^-) = (-ie)^2 \int d^4x_1 d^4x_2 : \bar{\psi}^-(x_1)\gamma_\mu\psi^+(x_1)ig^{\mu\nu}D(x_1-x_2)\bar{\psi}^+(x_2)\gamma_\nu\psi^-(x_2) : \quad (8.112)$$

and

$$S_b(e^+e^- \rightarrow e^+e^-) = (-ie)^2 \int d^4x_1 d^4x_2 : \bar{\psi}^-(x_1)\gamma_\mu\psi^-(x_1)ig^{\mu\nu}D(x_1-x_2)\bar{\psi}^+(x_2)\gamma_\nu\psi^+(x_2) : \quad (8.113)$$

The term $S_4^{(2)}$ gives rise to the two possibilities $e^- \rightarrow e^-$ and $e^+ \rightarrow e^+$. These are not scattering processes, but the exchange of the photon change the intrinsic property of the electron, in particular the mass. They are called self-energy contributions. For the electron we have the diagram of Fig. 8.11 with a contribution given by

$$S_4^{(2)} = (-ie)^2 \int d^4x_1 d^4x_2 \bar{\psi}^-(x_1)\gamma_\mu iS_F(x_1-x_2)ig^{\mu\nu}D(x_1-x_2)\gamma_\nu\psi^+(x_2) \quad (8.114)$$

In analogous way the term $S_2^{(5)}$ contributes to the self-energy of the photon. However, as we shall show in the following, it cannot change the mass of the photon which

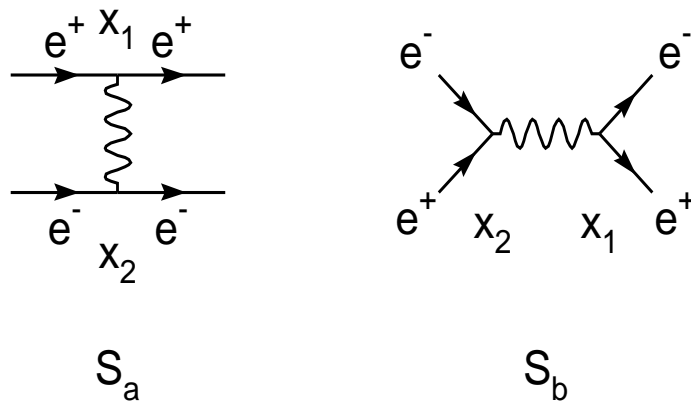

Fig. 8.10 -Inequivalent diagrams for the process $e^+e^- \rightarrow e^+e^-$.

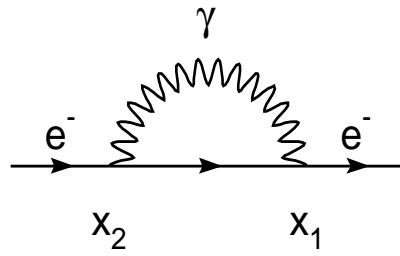

Fig. 8.11 -Electron self-energy.

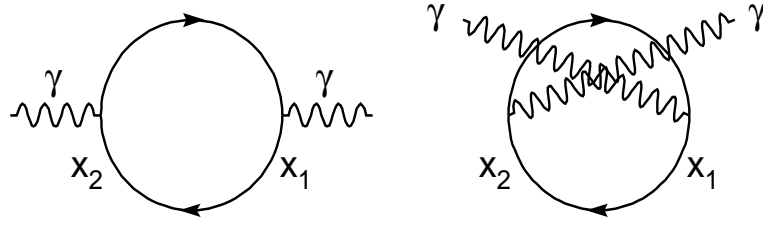

Fig. 8.12 -Photon self-energy.

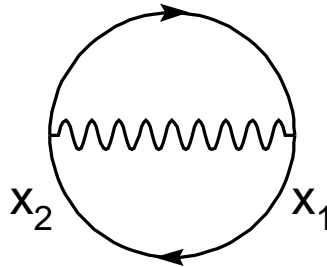

Fig. 8.13 -Vacuum diagram.

8.5 Feynman diagrams in momentum space

As we noticed already, in a typical experiment in particle physics we prepare beams of particles with definite momentum, polarization, etc. At the same time we measure momenta and polarizations of the final states. For this reason it is convenient to work in a momentum representation. Let us recall the expressions for the fermion and the photon propagators (see eqs. (7.29) and (7.31))

$$S_F(x) = \frac{1}{(2\pi)^4} \int d^4p e^{-ipx} S_F(p) \quad (8.116)$$

and

$$D(x) = \frac{1}{(2\pi)^4} \int d^4p e^{-ipx} D(p) \quad (8.117)$$

where

$$S_F(p) = \frac{1}{\hat{p} - m + i\epsilon} \quad (8.118)$$

and

$$D(p) = -\frac{1}{p^2 + i\epsilon} \quad (8.119)$$

From the fields expansion in terms of creation and annihilation operators, one can evaluate the action of the positive frequency part of ψ , $\bar{\psi}$ e A_μ on the one particle states. We get

$$\psi^+(x)|e^-(p, r)\rangle = \sum_{\pm s} \int d^3k \sqrt{\frac{m}{(2\pi)^3 E_k}} e^{-ikx} u(k, s) b(k, s) b^\dagger(p, r)|0\rangle \quad (8.120)$$

and using

$$[b(k, s), b^\dagger(p, r)]_+ = \delta_{rs} \delta^3(\vec{p} - \vec{k}) \quad (8.121)$$

it follows

$$\psi^+(x)|e^-(p, r)\rangle = \sqrt{\frac{m}{(2\pi)^3 E_k}} u(p, r) e^{-ipx} |0\rangle \quad (8.122)$$

For later applications it is more convenient to use the normalization in a box than the continuous one. This amounts to the substitution

$$\frac{1}{\sqrt{(2\pi)^3}} \rightarrow \frac{1}{\sqrt{V}} \quad (8.123)$$

and to use discrete momenta $\vec{p} = (2\pi/L)^3 \vec{n}$. We get

$$\psi^+(x)|e^-(p, r)\rangle = \sqrt{\frac{m}{VE_p}} u(p, r) e^{-ipx} |0\rangle \quad (8.124)$$

$$\bar{\psi}^+(x)|e^+(p, r)\rangle = \sqrt{\frac{m}{VE_p}} \bar{v}(p, r) e^{-ipx} |0\rangle \quad (8.125)$$

and for the photon

$$A_\mu^+(x)|\gamma(k, \lambda)\rangle = \sqrt{\frac{1}{2VE_k}} \epsilon_\mu^{(\lambda)}(k) e^{-ikx} |0\rangle \quad (8.126)$$

By conjugating these expressions we obtain the action of the negative frequency operators on the bras.

As an example let us consider a process associated to $S^{(1)}$

$$|i\rangle = |e^-(p)\rangle \rightarrow |f\rangle = |e^-(p'), \gamma(k)\rangle \quad (8.127)$$

From (8.91) we get

$$\begin{aligned} \langle f|S^{(1)}|i\rangle &= -ie \int d^4x \langle e^-(p'), \gamma(k) | \bar{\psi}^-(x) A_\mu^-(x) \gamma^\mu \psi^+(x) | e^-(p) \rangle \\ &= -ie \int d^4x \left(\sqrt{\frac{m}{VE_{p'}}} \bar{u}(p') e^{ip'x} \right) \\ &\times \left(\sqrt{\frac{1}{2VE_k}} \hat{\epsilon}(k) e^{ikx} \right) \left(\sqrt{\frac{m}{VE_p}} u(p) e^{-ipx} \right) \\ &= -ie \frac{m}{\sqrt{V^3 E_p E_{p'} 2E_k}} (2\pi)^4 \delta^4(p' + k - p) \bar{u}(p') \hat{\epsilon}(k) u(p) \end{aligned} \quad (8.128)$$

This expression can be written as

$$\langle f|S^{(1)}|i\rangle = (2\pi)^4 \delta^4(p' + k - p) \sqrt{\frac{m}{VE_p}} \sqrt{\frac{m}{VE_{p'}}} \sqrt{\frac{1}{2VE_k}} \mathcal{M} \quad (8.129)$$

where

$$\mathcal{M} = -ie\bar{u}(p')\hat{\epsilon}(k)u(p) \quad (8.130)$$

is called the Feynman amplitude for the process. Notice that \mathcal{M} is a Lorentz invariant quantity. The term $(2\pi)^4\delta^4(p' + k - p)$ gives the conservation of the four momentum in the process, whereas the other factors are associated to the various external particles (incoming and outgoing). As we said previously this process is not physically possible since it does not respect the four momentum conservation.

This structure is quite general and for any process we will have the delta-function expressing the four momentum conservation, and factors as $\sqrt{m/VE_p}$ for each external fermion and $\sqrt{1/2VE_k}$ for each boson. Now we have to investigate the rules for evaluating \mathcal{M} . To this end let us consider the Compton scattering

$$|i\rangle = |e^-(p), \gamma(k)\rangle \rightarrow |f\rangle = |e^-(p'), \gamma(k')\rangle \quad (8.131)$$

The S matrix element for the Compton scattering is given in eqs. (8.104)-(8.105)

$$S_2^{(2)}(\gamma e^- \rightarrow \gamma e^-) = S_a + S_b \quad (8.132)$$

and

$$\begin{aligned} \langle f|S_a|i\rangle &= (-ie)^2 \int d^4x_1 d^4x_2 \sqrt{\frac{m}{VE_p}} \sqrt{\frac{m}{VE_{p'}}} \sqrt{\frac{1}{2VE_k}} \sqrt{\frac{1}{2VE_{k'}}} \\ &\times \bar{u}(p')e^{ip'x_1}\hat{\epsilon}(k')e^{ik'x_1} \frac{i}{(2\pi)^4} \int d^4q e^{-iq(x_1 - x_2)} S_F(q) \\ &\quad \hat{\epsilon}(k)e^{-ikx_2}u(p)e^{-ipx_2} \\ &= (-ie)^2 \int d^4x_1 d^4x_2 \int \frac{d^4q}{(2\pi)^4} \sqrt{\frac{m}{VE_p}} \sqrt{\frac{m}{VE_{p'}}} \sqrt{\frac{1}{2VE_k}} \sqrt{\frac{1}{2VE_{k'}}} \\ &\times e^{i(p' + k' - q)x_1} e^{-i(p + k - q)x_2} \epsilon_\mu(k')\epsilon_\nu(k)\bar{u}(p')\gamma^\mu \frac{i}{\hat{q} - m + i\epsilon} \gamma^\nu u(p) \\ &= (2\pi)^4\delta^4(p' + k' - p - k) \sqrt{\frac{m}{VE_p}} \sqrt{\frac{m}{VE_{p'}}} \sqrt{\frac{1}{2VE_k}} \sqrt{\frac{1}{2VE_{k'}}} \\ &\times \epsilon_\mu(k')\epsilon_\nu(k)\bar{u}(p')(-ie\gamma^\mu) \frac{i}{\hat{p} + \hat{k} - m + i\epsilon} (-ie\gamma^\nu)u(p) \end{aligned} \quad (8.133)$$

Also this expression can be written in the form

$$\langle f|S_a|i\rangle = (2\pi)^4\delta^4(p' + k' - p - k) \sqrt{\frac{m}{VE_p}} \sqrt{\frac{m}{VE_{p'}}} \sqrt{\frac{1}{2VE_k}} \sqrt{\frac{1}{2VE_{k'}}} \mathcal{M}_a \quad (8.134)$$

with

$$\mathcal{M}_a = \epsilon_\mu(k')\epsilon_\nu(k)\bar{u}(p')(-ie\gamma^\mu) \frac{i}{\hat{q} - m + i\epsilon} (-ie\gamma^\nu)u(p), \quad q = p + k \quad (8.135)$$

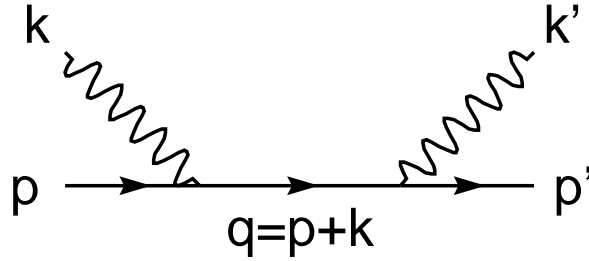

Fig. 8.13 - Contribution to the Compton scattering.

We will associate to this expression the diagram in Fig 8.13. The four momentum q is determined by the conservation of the four momentum at the vertices: $q = p + k = p' + k'$. However notice that in general $q^2 \neq m^2$, that is the exchanged particle (described by the propagator) is not a real particle but a **virtual** one. Looking at the previous expression one understands immediately how the various pieces are connected to the graphical elements in the diagram. In fact we have the following rules for any given diagram (Feynman diagram)

- for each vertex there is a factor $-ie\gamma_\mu$
- for each internal fermion line there is a factor $iS_F(p)$ (propagator)
- for each ingoing and/or outgoing fermionic line there is a factor $u(p)$ and/or $\bar{u}(p)$
- for each ingoing and/or outgoing photon line there is a factor ϵ_μ^λ (or its complex conjugate for outgoing photons if we consider complex polarizations as the circular one).

Notice also that the spinorial factor start from the external states and end up with the ingoing ones. The further contribution to the Compton scattering (given by S_b) corresponds to the diagram in Fig. 8.14, and using the previous rules we get

$$\mathcal{M}_b = \bar{u}(p')(-ie\gamma_\mu) \frac{i}{\hat{q} - m + i\epsilon} (-ie\gamma_\nu) u(p) \epsilon^\mu(k) \epsilon^\nu(k'), \quad q = p - k' \quad (8.136)$$

If we write down the Compton amplitude for the positrons we see that we must associate $\bar{v}(p)$, $v(p)$ to the initial and final states respectively. This is seen from eq. (8.125) which shows that the annihilation operator for the positrons is associated to $\bar{v}(p)$. For this reason, when drawing the diagrams in momentum space, is often convenient to invert the direction of the positron lines, in such a way that the barred spinors are always written to the left and the unbarred to the right (see Fig. 8.15).

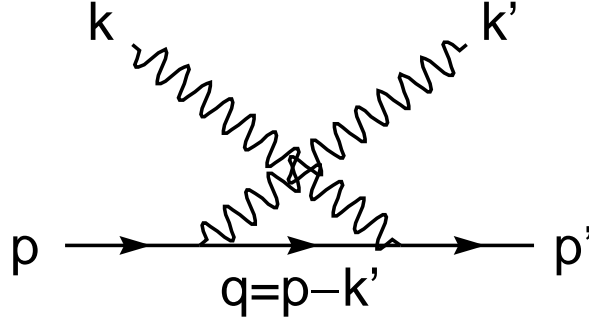

Fig. 8.14 - *The crossed contribution to the Compton scattering.*

In this case one has to be careful with the direction of the momenta which flow in direction opposite to the arrow in the case of the antiparticles. As for the internal lines, there is no distinction between particles and antiparticles, therefore, in general one draws the arrows in a way consistent with the flow of the momenta. Consider now e^-e^- scattering. The diagrams for this process are in Fig. 8.16, and the matrix element is given by

$$\langle f|S_3^{(2)}|i\rangle = (2\pi)^4 \delta^4(p'_1 + p'_2 - p_1 - p_2) \prod_{i=1}^4 \sqrt{\frac{m}{VE_i}} \mathcal{M} \quad (8.137)$$

where $\mathcal{M} = \mathcal{M}_a + \mathcal{M}_b$, with

$$M_a = \bar{u}(p'_1)(-ie\gamma_\mu)u(p_1)ig^{\mu\nu}D(p_2 - p'_2)\bar{u}(p'_2)(-ie\gamma_\nu)u(p_2) \quad (8.138)$$

and

$$M_b = -\bar{u}(p'_2)(-ie\gamma_\mu)u(p_1)ig^{\mu\nu}D(p_2 - p'_1)\bar{u}(p'_1)(-ie\gamma_\nu)u(p_2) \quad (8.139)$$

The relative minus sign comes from the exchange of the two electrons in the initial state, that is from the Fermi statistics.

From this example we get the further rule for the Feynman diagrams

- - for each internal photon line there is a factor $ig^{\mu\nu}D(p)$ (propagator).

As a last example let us consider the electron self-energy

$$|i\rangle = |e^-(p)\rangle \rightarrow |f\rangle = |e^-(p')\rangle \quad (8.140)$$

the S matrix element is

$$\langle f|S_4^{(2)}|i\rangle = -e^2 \int d^4x_1 d^4x_2 \sqrt{\frac{m}{VE_{p'}}} \sqrt{\frac{m}{VE_p}} \bar{u}(p') e^{ip'x_1}$$

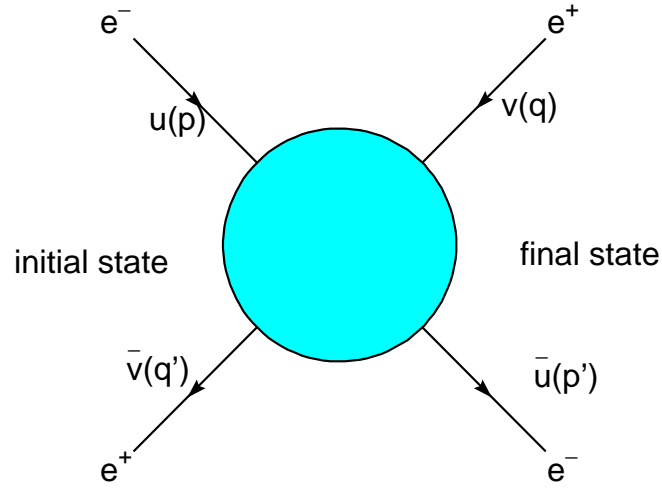

Fig. 8.15 - *The spinor conventions for antifermions.*

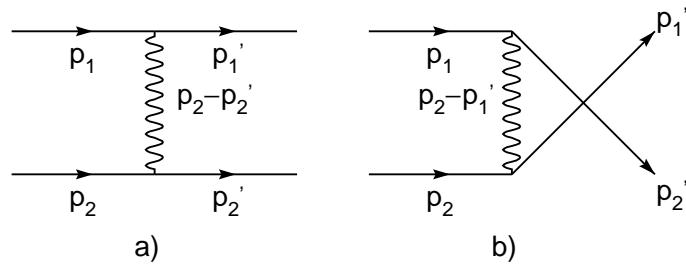

Fig. 8.16 - *The Feynman diagrams for the scattering $e^-e^- \rightarrow e^-e^-$.*

$$\begin{aligned}
& \times \gamma_\mu \int \frac{d^4 q_1}{(2\pi)^4} e^{-iq_1(x_1 - x_2)} iS_F(q_1) \\
& \times \gamma_\nu \int \frac{d^4 q_2}{(2\pi)^4} e^{-iq_2(x_1 - x_2)} iD(q_2) u(p) e^{-ipx_2} \\
& = \sqrt{\frac{m}{VE_{p'}}} \sqrt{\frac{m}{VE_p}} \int \frac{d^4 q_1}{(2\pi)^4} \frac{d^4 q_2}{(2\pi)^4} (2\pi)^4 \delta^4(p' - q_1 - q_2) (2\pi)^4 \delta^4(p - q_1 - q_2) \\
& \times \bar{u}(p') (-ie\gamma_\mu) iS_F(q_1) (-ie\gamma_\nu) u(p) ig^{\mu\nu} D(q_2) \\
& = (2\pi)^4 \delta^4(p' - p) \sqrt{\frac{m}{VE_{p'}}} \sqrt{\frac{m}{VE_p}} \mathcal{M} \tag{8.141}
\end{aligned}$$

where in the last term we have integrated over q_1 . \mathcal{M} is given by

$$\mathcal{M} = \int \frac{d^4 q_2}{(2\pi)^4} \bar{u}(p') (-ie\gamma_\mu) iS_F(p - q_2) (-ie\gamma_\nu) u(p) ig^{\mu\nu} D(q_2) \quad (8.142)$$

which correspond to the diagram in Fig. 8.17.

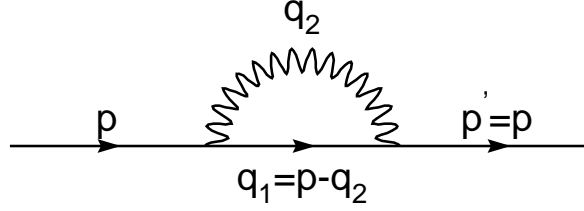

Fig. 8.16 - *The Feynman diagram for the electron self-energy.*

We see that the rule of conservation of the four momentum is always valid and also, that we have to integrate with measure $d^4 q/(2\pi)^4$ over all the momenta which are not determined by this conservation law. For the general case it is more convenient to formulate this rule in the following way:

- for each vertex there is an explicit factor $(2\pi)^4 \delta^4(\sum_i p_i)$, where p_i are the momenta entering the vertex
- integrate all the internal momenta with a measure $d^4 p_i/(2\pi)^4$

In this way the factor $(2\pi)^4 \delta^4(\sum p^{ext})$ is automatically produced. We can verify the previous rule in the self-energy case

$$\begin{aligned} & \int \frac{d^4 q_1}{(2\pi)^4} \int \frac{d^4 q_2}{(2\pi)^4} (2\pi)^4 \delta^4(q_1 + q_2 - p) (2\pi)^4 \delta^4(p' - q_1 - q_2) \\ = & (2\pi)^4 \delta^4(p' - p) \int \frac{d^4 q_2}{(2\pi)^4} \end{aligned} \quad (8.143)$$

As a last rule we recall

- for each fermionic loop there is a factor (-1).

Chapter 9

Applications

9.1 The cross-section

Let us consider a scattering process with a set of initial particles with four momenta $p_i = (E_i, \vec{p}_i)$ which collide and produce a set of final particles with four momenta $p_f = (E_f, \vec{p}_f)$. From the rules of the previous Chapter we know that each external photon line contributes with a factor $(1/2VE)^{1/2}$, whereas each external fermionic line contributes with $(m/VE)^{1/2}$. Furthermore the conservation of the total four momentum gives a term $(2\pi)^4 \delta^4(\sum_i p_i - \sum_f p_f)$. If we separate in the S matrix the term 1 corresponding at no scattering events we can write

$$S_{fi} = \delta_{fi} + (2\pi)^4 \delta^4 \left(\sum_i p_i - \sum_f p_f \right) \prod_{\text{fermioni}} \left(\frac{m}{VE} \right)^{1/2} \prod_{\text{bosoni}} \left(\frac{1}{2VE} \right)^{1/2} \mathcal{M} \quad (9.1)$$

where \mathcal{M} is the Feynman amplitude which can be evaluated by drawing the corresponding Feynman diagrams and using the rules of the previous Chapter.

Let us consider the typical case of a two particle collision giving rise to an N particles final state. Since we are interested to a situation with the final state different from the initial one, the probability for the transition will be the modulus square of the second term in eq. (9.1). In doing this operation we encounter the square of the Dirac delta which is not a definite quantity. However we should recall that we are quantizing the theory in a box, and really considering the system in a finite, although large, time interval that we parameterize as $(-T/2, T/2)$. Therefore we have not really to do with the delta function but rather with $(P_{i,f} = \sum_{i,f} p_{i,f})$

$$(2\pi)^4 \delta^4(P_f - P_i) \rightarrow \int_V d^3x \int_{-T/2}^{T/2} dt e^{i(P_f - P_i)x} \quad (9.2)$$

Consider one of the factors appearing in this equation, for instance the time integral. By performing the integration we get $(\Delta E = E_f - E_i)$

$$\int_{-T/2}^{T/2} dt e^{i\Delta E t} = \frac{2 \sin(T\Delta E/2)}{\Delta E} \quad (9.3)$$

And evaluating the modulus square

$$|(2\pi)\delta(E_f - E_i)|^2 \rightarrow \frac{4 \sin^2(T\Delta E/2)}{(\Delta E)^2} \quad (9.4)$$

On the right hand side we have a function of ΔE , whose integral holds $2\pi T$, and has a peak at $\Delta E = 0$. Therefore in the $T \rightarrow \infty$ limit we have a delta-convergent sequence

$$\lim_{T \rightarrow \infty} \frac{4 \sin^2(T\Delta E/2)}{(\Delta E)^2} = 2\pi T \delta(E_f - E_i) \quad (9.5)$$

By doing the same operations also for the space integrals we get

$$|(2\pi)^4 \delta^4(P_f - P_i)|^2 \rightarrow (2\pi)^4 L^3 T \delta^4(P_f - P_i) \quad (9.6)$$

where L is the side of the volume $V = L^3$. Therefore, the probability per unit time of the transition is

$$w = V(2\pi)^4 \delta^4(P_f - P_i) \prod_i \frac{1}{2VE_i} \prod_f \frac{1}{2VE_f} \prod_{\text{fermioni}} (2m) |\mathcal{M}|^2 \quad (9.7)$$

where, for reasons of convenience, we have written

$$\frac{m}{VE} = (2m) \frac{1}{2VE} \quad (9.8)$$

w gives the probability per unit time of a transition toward a state with well defined quantum numbers, but we are rather interested to the final states having momenta between \vec{p}_f and $\vec{p}_f + d\vec{p}_f$. Since in the volume V the momentum is given by $\vec{p} = 2\pi\vec{n}/L$, the number of final states is given by

$$\left(\frac{L}{2\pi}\right)^3 d^3p \quad (9.9)$$

The cross-section is defined as the probability per unit time divided by the flux of the ingoing particles, and has the dimensions of a length to the square

$$[t^{-1}\ell^2 t] = [\ell^2] \quad (9.10)$$

In fact the flux is defined as $v_{\text{rel}}\rho = v_{\text{rel}}/V$, since in our normalization we have a particle in the volume V , and v_{rel} is the relative velocity of the ingoing particles. For the bosons this follows from the normalization condition (3.41). For the fermions recall that in the box normalization the wave function is

$$\sqrt{\frac{m}{EV}} u(p) e^{-ipx} \quad (9.11)$$

from which

$$\int_V d^3x \rho(x) = \int_V d^3x \frac{m}{VE} u^\dagger(p) u(p) = 1 \quad (9.12)$$

Then the cross-section for getting the final states with momenta between \vec{p}_f e $\vec{p}_f + d\vec{p}_f$ is given by

$$d\sigma = w \frac{V}{v_{\text{rel}}} dN_F = w \frac{V}{v_{\text{rel}}} \prod_f \frac{V d^3 p_f}{(2\pi)^3} \quad (9.13)$$

We obtain

$$\begin{aligned} d\sigma &= \frac{V}{v_{\text{rel}}} \prod_f \frac{V d^3 p_f}{(2\pi)^3} V (2\pi)^4 \delta^4(P_f - P_i) \frac{1}{4V^2 E_1 E_2} \prod_f \frac{1}{2V E_f} \prod_{\text{fermioni}} (2m) |\mathcal{M}|^2 \\ &= (2\pi)^4 \delta^4(P_f - P_i) \frac{1}{4E_1 E_2 v_{\text{rel}}} \prod_{\text{fermioni}} (2m) \prod_f \frac{d^3 p_f}{(2\pi)^3 2E_f} |\mathcal{M}|^2 \end{aligned} \quad (9.14)$$

Notice that the dependence on the quantization volume V disappears, as it should be, in the final equation. Furthermore, the total cross-section, which is obtained by integrating the previous expression over all the final momenta, is Lorentz invariant. In fact, as it follows from the Feynman rules, \mathcal{M} is invariant, as the factors $d^3 p/2E$. Furthermore

$$\vec{v}_{\text{rel}} = \vec{v}_1 - \vec{v}_2 = \frac{\vec{p}_1}{E_1} - \frac{\vec{p}_2}{E_2} \quad (9.15)$$

but in the frame where the particle 2 is at rest (laboratory frame) we have $p_2 = (m_2, \vec{0})$ and $\vec{v}_{\text{rel}} = \vec{v}_1$, from which

$$\begin{aligned} E_1 E_2 |\vec{v}_{\text{rel}}| &= E_1 m_2 \frac{|\vec{p}_1|}{E_1} = m_2 |\vec{p}_1| = m_2 \sqrt{E_1^2 - m_1^2} \\ &= \sqrt{m_2^2 E_1^2 - m_1^2 m_2^2} = \sqrt{(p_1 \cdot p_2)^2 - m_1^2 m_2^2} \end{aligned} \quad (9.16)$$

We see that also this factor is Lorentz invariant.

9.2 The scattering $e^+ e^- \rightarrow \mu^+ \mu^-$

In order to exemplify the previous techniques we will study the process $e^+ e^- \rightarrow \mu^+ \mu^-$. The interaction lagrangian density is

$$\mathcal{L}_I = -e \left[\bar{\psi}_e \gamma^\lambda \psi_e + \bar{\psi}_\mu \gamma^\lambda \psi_\mu \right] A_\lambda \quad (9.17)$$

Fig. 9.1 describes the Feynman diagram for this process at the second order (in this diagram the arrows are oriented according to the direction of the momenta). Notice that in contrast to the process $e^+ e^- \rightarrow e^+ e^-$ the diagram in the crossed channel of Fig. 9.2 is now missing.

The Feynman amplitude is

$$\begin{aligned} \mathcal{M} &= \bar{u}(p_4, r_4) (-ie\gamma_\mu) v(p_3, r_3) \frac{-ig^{\mu\nu}}{(p_1 + p_2)^2} \bar{v}(p_1, r_1) (-ie\gamma_\nu) u(p_2, r_2) \\ &= ie^2 \bar{u}(p_4, r_4) \gamma_\mu v(p_3, r_3) \frac{1}{(p_1 + p_2)^2} \bar{v}(p_1, r_1) \gamma^\mu u(p_2, r_2) \end{aligned} \quad (9.18)$$

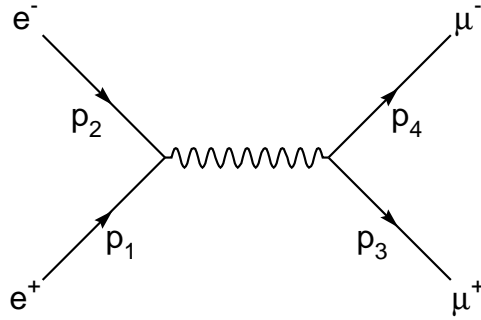

Fig. 9.1 - The Feynman diagram for the scattering $e^+e^- \rightarrow \mu^+\mu^-$.

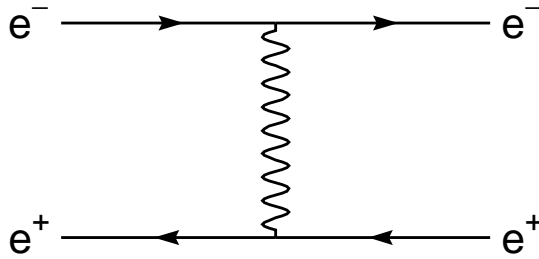

Fig. 9.2 - The crossed diagram for the scattering $e^+e^- \rightarrow e^+e^-$.

where we have introduced the polarization of the fermions r_i (the direction of the spin in the rest frame). Often one is interested in unpolarized cross-sections. In that case one has to sum the cross-section over the final polarizations and to average the initial ones. That is we need the following quantity

$$X = \frac{1}{4} \sum_{r_i} |\mathcal{M}|^2 \quad (9.19)$$

where

$$\mathcal{M}^* = -ie^2 \bar{v}(p_3, r_3) \gamma_\mu u(p_4, r_4) \frac{1}{(p_1 + p_2)^2} \bar{u}(p_2, r_2) \gamma^\mu v(p_1, r_1) \quad (9.20)$$

This expression can be written in the following form

$$\mathcal{M} = \frac{ie^2}{(p_1 + p_2)^2} A_\mu^{\text{muons}}(r_3, r_4) A_{\text{electrons}}^\mu(r_1, r_2) \quad (9.21)$$

with

$$A_\mu^{\text{muons}} = \bar{u}(p_4, r_4) \gamma_\mu v(p_3, r_3)$$

$$A_{\mu}^{\text{electrons}} = \bar{v}(p_1, r_1)\gamma_{\mu}u(p_2, r_2) \quad (9.22)$$

We get

$$X = \frac{1}{4} \frac{e^4}{(p_1 + p_2)^4} \sum_{r_1, r_2} \left(A_{\mu}^{\text{electrons}} A_{\nu}^{\star \text{electrons}} \right) \sum_{r_3, r_4} \left(A_{\mu}^{\text{muons}} A_{\nu}^{\star \text{muons}} \right) \quad (9.23)$$

Defining the quantity

$$A_{\mu\nu}^{\text{electrons}} = \sum_{r_1, r_2} \left(A_{\mu}^{\text{electrons}} A_{\nu}^{\star \text{electrons}} \right) = \sum_{r_1, r_2} \bar{v}(p_1, r_1)\gamma_{\mu}u(p_2, r_2)\bar{u}(p_2, r_2)\gamma_{\nu}v(p_1, r_1) \quad (9.24)$$

and using the eqs. (4.100) and (4.101) for the positive and negative energy projectors, we obtain

$$A_{\mu\nu}^{\text{electrons}} = Tr \left[\frac{\hat{p}_1 - m_e}{2m_e} \gamma_{\mu} \frac{\hat{p}_2 + m_e}{2m_e} \gamma_{\nu} \right] \quad (9.25)$$

and the analogous quantity for the muons

$$A_{\mu\nu}^{\text{muons}} = Tr \left[\frac{\hat{p}_4 + m_{\mu}}{2m_{\mu}} \gamma_{\mu} \frac{\hat{p}_3 - m_{\mu}}{2m_{\mu}} \gamma_{\nu} \right] \quad (9.26)$$

To evaluate the trace of Dirac matrices we may use several theorems. Let us start showing that the trace of an odd number of gamma matrices is zero. In fact for odd n

$$\begin{aligned} Tr [\hat{a}_1 \cdots \hat{a}_n] &= Tr [\hat{a}_1 \cdots \hat{a}_n \gamma_5 \gamma_5] = Tr [\gamma_5 \hat{a}_1 \cdots \hat{a}_n \gamma_5] \\ &= (-1)^n Tr [\hat{a}_1 \cdots \hat{a}_n] \end{aligned} \quad (9.27)$$

where we have used the cyclic property of the trace and the anticommutativity of γ_5 and γ_{μ} . Obviously we have

$$Tr[1] = 4 \quad (9.28)$$

Furthermore

$$Tr[\hat{a}\hat{b}] = \frac{1}{2} Tr[\hat{a}\hat{b} + \hat{b}\hat{a}] = \frac{1}{2} a_{\mu} b_{\nu} Tr([\gamma^{\mu}, \gamma^{\nu}]_{+}) = 4a_{\mu} b_{\nu} g^{\mu\nu} = 4a \cdot b \quad (9.29)$$

Then, using $\hat{a}\hat{b} = -\hat{b}\hat{a} + 2a \cdot b$ we can evaluate

$$\begin{aligned} Tr[\hat{a}_1 \hat{a}_2 \hat{a}_3 \hat{a}_4] &= Tr[(-\hat{a}_2 \hat{a}_1 + 2a_1 \cdot a_2) \hat{a}_3 \hat{a}_4] \\ &= -Tr[\hat{a}_2(-\hat{a}_3 \hat{a}_1 + 2a_1 \cdot a_3) \hat{a}_4] + 8(a_1 \cdot a_2)(a_3 \cdot a_4) \\ &= Tr[\hat{a}_2 \hat{a}_3(-\hat{a}_4 \hat{a}_1 + 2a_1 \cdot a_4)] - 8(a_1 \cdot a_3)(a_2 \cdot a_4) + 8(a_1 \cdot a_2)(a_3 \cdot a_4) \\ &= -Tr[\hat{a}_2 \hat{a}_3 \hat{a}_4 \hat{a}_1] + 8(a_1 \cdot a_4)(a_2 \cdot a_3) \\ &\quad - 8(a_1 \cdot a_3)(a_2 \cdot a_4) + 8(a_1 \cdot a_2)(a_3 \cdot a_4) \end{aligned} \quad (9.30)$$

that is

$$Tr[\hat{a}_1 \hat{a}_2 \hat{a}_3 \hat{a}_4] = 4[(a_1 \cdot a_2)(a_3 \cdot a_4) - (a_1 \cdot a_3)(a_2 \cdot a_4) + (a_1 \cdot a_4)(a_2 \cdot a_3)] \quad (9.31)$$

This relation can be easily extended by induction. Other useful properties are

$$\gamma_\mu \gamma^\mu = 4 \quad (9.32)$$

$$\gamma_\mu \hat{a} \gamma^\mu = (-\hat{a} \gamma_\mu + 2a_\mu) \gamma^\mu = -2\hat{a} \quad (9.33)$$

and

$$\gamma_\mu \hat{a} \hat{b} \gamma^\mu = 4a \cdot b \quad (9.34)$$

Let us go back to our process. Evaluating the trace we get

$$\begin{aligned} A_{\text{electrons}}^{\mu\nu} &= \frac{1}{4m_e^2} \text{Tr}[(\hat{p}_1 \gamma^\mu \hat{p}_2 \gamma^\nu) - m_e^2 \gamma^\mu \gamma^\nu] \\ &= \frac{1}{m_e^2} [p_1^\mu p_2^\nu - g^{\mu\nu} (p_1 \cdot p_2) + p_1^\nu p_2^\mu - m_e^2 g^{\mu\nu}] \\ &= \frac{1}{m_e^2} [p_1^\mu p_2^\nu + p_1^\nu p_2^\mu - g^{\mu\nu} (p_1 \cdot p_2 + m_e^2)] \end{aligned} \quad (9.35)$$

Analogously we get

$$A_{\text{muons}}^{\mu\nu} = \frac{1}{m_\mu^2} [p_3^\mu p_4^\nu + p_3^\nu p_4^\mu - g^{\mu\nu} (p_3 \cdot p_4 + m_\mu^2)] \quad (9.36)$$

Substituting into X we get

$$\begin{aligned} X &= \frac{1}{4} \frac{e^4}{(p_1 + p_2)^4} \frac{1}{m_e^2 m_\mu^2} [2(p_1 \cdot p_3)(p_2 \cdot p_4) + 2(p_1 \cdot p_4)(p_2 \cdot p_3) - 2(p_1 \cdot p_2)(p_3 \cdot p_4 + m_\mu^2) \\ &\quad - 2(p_3 \cdot p_4)(p_1 \cdot p_2 + m_e^2) + 4(p_1 \cdot p_2 + m_e^2)(p_3 \cdot p_4 + m_\mu^2)] \\ &= \frac{e^4}{2m_e^2 m_\mu^2 (p_1 + p_2)^4} [(p_1 \cdot p_3)(p_2 \cdot p_4) + (p_1 \cdot p_4)(p_2 \cdot p_3) \\ &\quad + m_\mu^2 (p_1 \cdot p_2) + m_e^2 (p_3 \cdot p_4) + 2m_e^2 m_\mu^2] \end{aligned} \quad (9.37)$$

This process is studied in the circular colliders where two beams, one of electrons and the other of positron with same energy are made to collide, and looking for a final pair $\mu^+ - \mu^-$. Therefore it is convenient to use the frame of the center of mass for the pair $e^+ - e^-$. We will choose the momentum variables as in Fig. 9.3 with

$$p_1 = (E, \vec{p}), \quad p_2 = (E, -\vec{p}), \quad p_3 = (E, \vec{p}'), \quad p_4 = (E, -\vec{p}') \quad (9.38)$$

In this frame the various scalar products are

$$p_1 \cdot p_3 = p_2 \cdot p_4 = E^2 - pp' \cos \theta, \quad p_1 \cdot p_4 = p_2 \cdot p_3 = E^2 + pp' \cos \theta \quad (9.39)$$

$$p_1 \cdot p_2 = E^2 + p^2, \quad p_3 \cdot p_4 = E^2 + p'^2, \quad (p_1 + p_2)^2 = 4E^2 \quad (9.40)$$

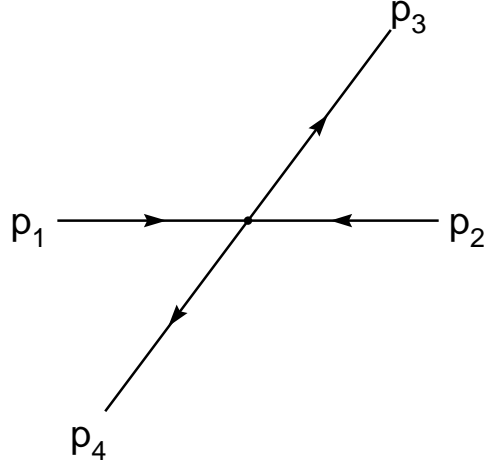

Fig. 9.3 - The Feynman diagram for the scattering $e^+e^- \rightarrow \mu^+\mu^-$.

In order the process is kinematically possible we must have $E > m_\mu \approx 200 m_e$. We can then neglect m_e with respect to E and m_μ , obtaining

$$\begin{aligned}
 X &= \frac{e^4}{2m_e^2 m_\mu^2} \frac{1}{16E^4} \left[(E^2 - pp' \cos \theta)^2 + (E^2 + pp' \cos \theta)^2 + m_\mu^2 (E^2 + p^2) \right] \\
 &= \frac{e^4}{32m_e^2 m_\mu^2 E^4} [2E^4 + 2E^2 p'^2 \cos^2 \theta + 2E^2 m_\mu^2] \\
 &= \frac{e^4}{16m_e^2 m_\mu^2} \frac{1}{E^2} [E^2 + p'^2 \cos^2 \theta + m_\mu^2] \tag{9.41}
 \end{aligned}$$

from which

$$\begin{aligned}
 d\sigma &= \frac{e^4}{16m_e^2 m_\mu^2} \frac{1}{E^2} [E^2 + p'^2 \cos^2 \theta + m_\mu^2] (2\pi)^4 \delta^4(p_1 + p_2 - p_3 - p_4) \frac{1}{4(E^2 + p^2)} \\
 &\times (2m_e)^2 (2m_\mu)^2 \frac{d^3 p_3 d^3 p_4}{(2\pi)^6 4E^2} \\
 &= \delta^4(p_1 + p_2 - p_3 - p_4) \frac{e^4}{128\pi^2} \frac{1}{E^6} [E^2 + p'^2 \cos^2 \theta + m_\mu^2] d^3 p_3 d^3 p_4 \tag{9.42}
 \end{aligned}$$

where we have used $E^2 = p^2$, since we are neglecting the electron mass. We can integrate this expression over four variables using the conservation of the four momentum given by the delta function. We will integrate over \vec{p}_4 e $|\vec{p}_3|$. Using $d^3 p_3 = p'^2 dp' d\Omega$ we get

$$\frac{d\sigma}{d\Omega} = \int p'^2 dp' \delta(E_1 + E_2 - E_3 - E_4) \frac{e^4}{128\pi^2} \frac{1}{E^6} (E^2 + p'^2 \cos^2 \theta + m_\mu^2)$$

$$= \left[\frac{\partial(E_3 + E_4)}{\partial p'} \right]^{-1} \frac{e^4 p'^2}{128\pi^2 E^6} (E^2 + p'^2 \cos^2 \theta + m_\mu^2) \quad (9.43)$$

The derivative can be evaluated by noticing that $E_3^2 = E_4^2 = m_\mu^2 + p'^2$

$$\frac{\partial(E_3 + E_4)}{\partial p'} = 2 \frac{p'}{E} \quad (9.44)$$

Using $e^2 = 4\pi\alpha$ we get the differential cross-section

$$\frac{d\sigma}{d\Omega} = \frac{\alpha^2 p'^2 E}{8 E^6 2p'} (E^2 + p'^2 \cos^2 \theta + m_\mu^2) = \frac{\alpha^2 p'}{16E^4 E} (E^2 + p'^2 \cos^2 \theta + m_\mu^2) \quad (9.45)$$

In the extreme relativistic limit $E \gg m_\mu$ ($p' \approx E$) we get the expression

$$\frac{d\sigma}{d\Omega} = \frac{\alpha^2}{16E^2} (1 + \cos^2 \theta) \quad (9.46)$$

from which we obtain the total cross-section

$$\sigma = \frac{\alpha^2}{16E^2} \int d\Omega (1 + \cos^2 \theta) = \frac{\alpha^2}{16E^2} 2\pi \int_{-1}^1 dw (1 + w^2) = \frac{\alpha^2 \pi}{3E^2} \quad (9.47)$$

In the general case we get

$$\begin{aligned} \sigma &= \frac{\alpha^2 p'}{16E^4 E} \int d\Omega (E^2 + p'^2 \cos^2 \theta + m_\mu^2) = \frac{\alpha^2 p'}{16E^4 E} 2\pi \left(2E^2 + \frac{2}{3} p'^2 + 2m_\mu^2 \right) \\ &= \frac{\pi \alpha^2 p'}{4E^4 E} \left(E^2 + \frac{1}{3} p'^2 + m_\mu^2 \right) \end{aligned} \quad (9.48)$$

In the high energy limit we can easily estimate the total cross-section. Recalling that

$$1 \text{ GeV}^{-2} = 0.389 \text{ mbarn} \quad (9.49)$$

we get

$$\sigma(\text{mbarn}) \approx \frac{5.6 \cdot 10^{-5}}{(E(\text{GeV}))^2} \cdot 0.389 \approx \frac{2.17 \cdot 10^{-5}}{(E(\text{GeV}))^2} \quad (9.50)$$

or in terms of nanobarns, $1 \text{ nbarn} = 10^{-6} \text{ mbarn}$,

$$\sigma \approx \frac{20 \text{ (nbarn)}}{(E(\text{GeV}))^2} \quad (9.51)$$

9.3 Coulomb scattering

Sometimes one can think to the electromagnetic field as an assigned quantity, in that case it will be described by a classical function rather than by an operator. This is the case for the scattering of electrons and positrons from an external field

as the Coulomb field of a heavy nucleus. The full electromagnetic will be of course, the sum of the classical part and of the quantized part. The expansion of the S matrix is still given by

$$S = 1 + \sum_{n=1}^{\infty} \frac{(i)^n}{n!} \int \cdots \int d^4x_1 \cdots d^4x_n T(\mathcal{L}_I(x_1) \cdots \mathcal{L}_I(x_n)) \quad (9.52)$$

with

$$\mathcal{L}_I(x) = -e : \bar{\psi}(x) \gamma^\mu \psi(x) [A_\mu(x) + A_\mu^{\text{ext}}(x)] : \quad (9.53)$$

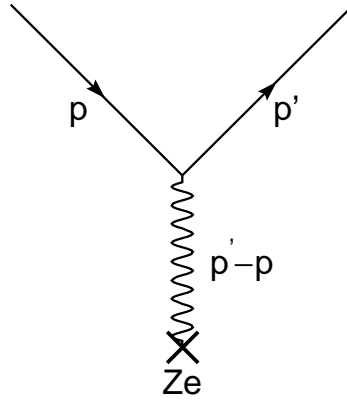

Fig. 9.4 - *The Feynman diagram for the Coulomb scattering of an electron.*

We will consider here the scattering of an electron from nucleus, that will be thought as infinitely heavy. Therefore it will give rise to a static Coulomb potential. Let us introduce the Fourier transform of this field

$$A_\mu^{\text{ext}}(\vec{x}) = \int \frac{d^3q}{(2\pi)^3} e^{i\vec{q} \cdot \vec{x}} A_\mu^{\text{ext}}(\vec{q}) \quad (9.54)$$

At the first order in the external field we have

$$S^{(1)} = -ie \int d^4x : \bar{\psi}(x) \gamma^\mu \psi(x) A_\mu^{\text{ext}}(\vec{x}) : \quad (9.55)$$

and the transition we consider is

$$|i\rangle = |e^-(p, r)\rangle \rightarrow |f\rangle = |e^-(p', s)\rangle \quad (9.56)$$

This is described by the diagram of Fig. 9.4 with contribution given by

$$\langle f | S^{(1)} | i \rangle = -ie \int d^4x \langle e^-(p', s) | \bar{\psi}^-(x) \gamma^\mu \psi^+(x) A_\mu^{\text{ext}}(\vec{x}) | e^-(p, r) \rangle$$

$$\begin{aligned}
&= -ie \left(\frac{m}{E_p V} \right)^{1/2} \left(\frac{m}{E_{p'} V} \right)^{1/2} \int d^4x e^{ip'x} \bar{u}(p', s) \\
&\times \int \frac{d^3q}{(2\pi)^3} e^{i\vec{q} \cdot \vec{x}} A_\mu^{\text{ext}}(\vec{q}) \gamma^\mu u(p, s) e^{-ipx} \\
&= -ie \left(\frac{m}{E_p V} \right)^{1/2} \left(\frac{m}{E_{p'} V} \right)^{1/2} (2\pi) \delta(E' - E) \\
&\times \int \frac{d^3q}{(2\pi)^3} (2\pi)^3 \delta^3(\vec{p} + \vec{q} - \vec{p}') \bar{u}(p', s) \gamma^\mu A_\mu^{\text{ext}}(\vec{q}) u(p, s) \\
&= (2\pi) \delta(E' - E) \left(\frac{m}{EV} \right) \mathcal{M} \tag{9.57}
\end{aligned}$$

with

$$\mathcal{M} = \bar{u}(p', s) (-ie\gamma^\mu) A_\mu^{\text{ext}}(\vec{p}' - \vec{p}) u(p, s) \tag{9.58}$$

Notice that in this case we have only the conservation of the energy, whereas the spatial momentum is not conserve. In fact the external field violates the translational invariance of the theory, and, as a consequence, the nucleus absorbs the momentum $\vec{p}' - \vec{p}$ from the electron. From the [previous expression we see also that when there are external fields the Feynman rules are modified, and we have to substitute the wave function of a photon

$$\left(\frac{1}{2E_q V} \right)^{1/2} \epsilon_\mu^{(\lambda)}(q) \tag{9.59}$$

with the Fourier transform of the external field

$$A_\mu^{\text{ext}}(\vec{q}) \tag{9.60}$$

The probability per unit time is given by

$$w = \frac{1}{T} |\langle f | S^{(1)} | i \rangle|^2 = 2\pi \delta(E' - E) \left(\frac{m}{EV} \right)^2 |\mathcal{M}|^2 \tag{9.61}$$

The expression for the density of final states is still ($p' = |\vec{p}'|$)

$$dN_f = \frac{V d^3p'}{(2\pi)^3} = \frac{V p'^2 dp' d\Omega}{(2\pi)^3} \tag{9.62}$$

Since $E'^2 = E^2 = p'^2 + m^2 = p^2 + m^2$. we have $p = |\vec{p}| = p'$, and $E' dE' = p' dp'$. Therefore

$$dN_f = V \frac{p' E' dE'}{(2\pi)^3} d\Omega \tag{9.63}$$

The incoming flux is $v/V = p/VE$, and we get

$$d\sigma = \frac{V w dN_f}{v} = \left(\frac{m}{2\pi} \right)^2 dE' \delta(E' - E) |\mathcal{M}|^2 d\Omega \tag{9.64}$$

The differential cross-section is obtained by integrating over the final energy of the electron

$$\frac{d\sigma}{d\Omega} = \left(\frac{m}{2\pi}\right)^2 |\mathcal{M}|^2 = \left(\frac{me}{2\pi}\right)^2 |\bar{u}(p', s)\gamma^\mu A_\mu^{\text{ext}}(\vec{q})u(p, r)|^2 \quad (9.65)$$

where $\vec{q} = \vec{p}' - \vec{p}$. Averaging over the initial polarizations and summing over the final ones we obtain

$$\frac{d\sigma}{d\Omega} = \left(\frac{me}{2\pi}\right)^2 \frac{1}{2} A_\mu^{\text{ext}}(\vec{q}) A_\nu^{\text{ext}}(\vec{q}) \text{Tr} \left[\frac{\hat{p}' + m}{2m} \gamma^\mu \frac{\hat{p} + m}{2m} \gamma^\nu \right] \quad (9.66)$$

From the evaluation of the trace we get

$$\text{Tr}[\dots] = \frac{1}{m^2} [p'_\mu p_\nu - g_{\mu\nu}(p' \cdot p) + p'_\nu p_\mu + g_{\mu\nu} m^2] \quad (9.67)$$

Assuming now that the external field is of Coulomb type, we have

$$A_\mu^{\text{ext}}(\vec{x}) = \left(-\frac{Ze}{4\pi|\vec{x}|}, \vec{0} \right) \quad (9.68)$$

and

$$A_0^{\text{ext}}(\vec{q}) = -\frac{Ze}{|\vec{q}|^2} \quad (9.69)$$

We see that we need only the terms with $\mu = \nu = 0$ from the trace

$$\text{Tr}[\dots] = \frac{1}{m^2} [E^2 + m^2 + \vec{p} \cdot \vec{p}'] \quad (9.70)$$

and since $\vec{p} \cdot \vec{p}' = p^2 \cos \theta$

$$\text{Tr}[\dots] = \frac{1}{m^2} [E^2 + m^2 + p^2 \cos \theta] \quad (9.71)$$

we get

$$\frac{d\sigma}{d\Omega} = 2 \frac{(Z\alpha)^2}{|\vec{q}|^4} (E^2 + m^2 + p^2 \cos \theta) \quad (9.72)$$

Using

$$|\vec{q}|^2 = |\vec{p}' - \vec{p}|^2 = 4p^2 \sin^2 \frac{\theta}{2} \quad (9.73)$$

$m^2 = E^2 - |\vec{p}|^2$, and $v = p/E$, we finally obtain

$$\frac{d\sigma}{d\Omega} = 2 \frac{(Z\alpha)^2}{(4p^2 \sin^2(\theta/2))^2} (E^2 + m^2 + p^2 \cos \theta) = \frac{(Z\alpha)^2}{4E^2 v^4 \sin^4(\theta/2)} [1 - v^2 \sin^2(\theta/2)] \quad (9.74)$$

In the non relativistic limit $v \ll 1$, $E \approx m$

$$\frac{d\sigma}{d\Omega} = \frac{(Z\alpha)^2}{4m^2 \sin^4(\theta/2)} \frac{1}{v^4} = \frac{(Z\alpha)^2}{16T^2 \sin^4(\theta/2)} \quad (9.75)$$

which is the classical Rutherford formula for the Coulomb scattering with $T = mv^2/2$.

Chapter 10

One-loop renormalization

10.1 Divergences of the Feynman integrals

Let us consider again the Coulomb scattering. If we expand the S matrix up to the third order in the electric charge, and we assume that the external field is weak enough such to take only the first order, we can easily see that the relevant Feynman diagrams are the ones of Fig. 10.1

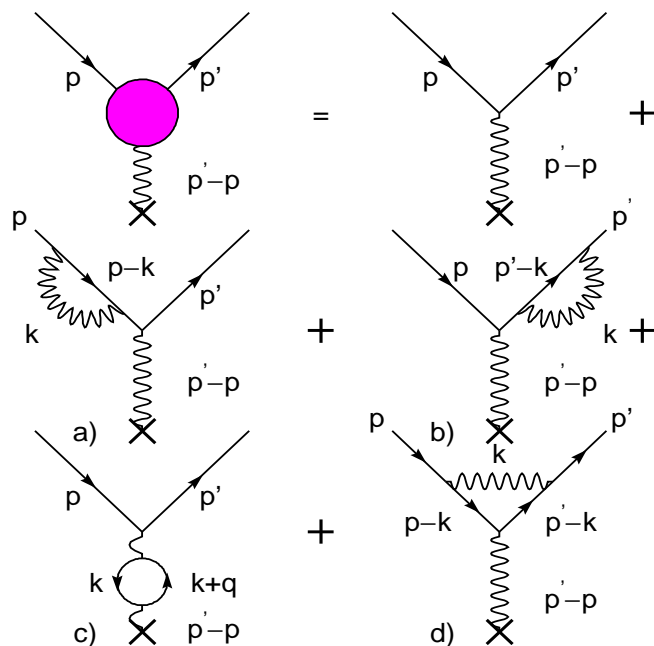

Fig. 10.1 - *The Feynman diagram for the Coulomb scattering at the third order in the electric charge and at the first order in the external field.*

The Coulomb scattering can be used, in principle, to define the physical electric charge of the electron. This is done assuming that the amplitude is linear in e_{phys} , from which we get an expansion of the type

$$e_{\text{phys}} = e + a_2 e^3 + \dots = e(1 + a_2 e^2 + \dots) \quad (10.1)$$

in terms of the parameter e which appears in the original lagrangian. The first problem we encounter is that we would like to have the results of our calculation in terms of measured quantities as e_{phys} . This could be done by inverting the previous expansion, but, and here comes the second problem, the coefficient of the expansion are divergent quantities. To show this, consider, for instance the self-energy contribution to one of the external photons (as the one in Fig. 10.1a). We have

$$\mathcal{M}_a = \bar{u}(p')(-ie\gamma^\mu)A_\mu^{\text{ext}}(\vec{p}' - \vec{p})\frac{i}{\hat{p} - m + i\epsilon} [ie^2\Sigma(p)] u(p) \quad (10.2)$$

where

$$\begin{aligned} ie^2\Sigma(p) &= \int \frac{d^4k}{(2\pi)^4} (-ie\gamma_\mu) \frac{-ig^{\mu\nu}}{k^2 + i\epsilon} \frac{i}{\hat{p} - \hat{k} - m + i\epsilon} (-ie\gamma_\nu) \\ &= -e^2 \int \frac{d^4k}{(2\pi)^4} \gamma_\mu \frac{1}{k^2 + i\epsilon} \frac{1}{\hat{p} - \hat{k} - m + i\epsilon} \gamma^\mu \end{aligned} \quad (10.3)$$

or

$$\Sigma(p) = i \int \frac{d^4k}{(2\pi)^4} \gamma_\mu \frac{\hat{p} - \hat{k} + m}{(p - k)^2 - m^2 + i\epsilon} \gamma^\mu \frac{1}{k^2 + i\epsilon} \quad (10.4)$$

For large momentum, k , the integrand behaves as $1/k^3$ and the integral diverges linearly. Analogously one can check that all the other third order contributions diverge. Let us write explicitly the amplitudes for the other diagrams

$$\mathcal{M}_b = \bar{u}(p')ie^2\Sigma(p')\frac{i}{\hat{p}' - m + i\epsilon} (-ie\gamma^\mu)A_\mu^{\text{ext}}(\vec{p}' - \vec{p})u(p) \quad (10.5)$$

$$\mathcal{M}_c = \bar{u}(p')(-ie\gamma^\mu)\frac{-ig_{\mu\nu}}{q^2 + i\epsilon} ie^2\Pi^{\nu\rho}(q)A_\rho^{\text{ext}}(\vec{p}' - \vec{p})u(p), \quad q = p' - p \quad (10.6)$$

where

$$ie^2\Pi^{\mu\nu}(q) = (-1) \int \frac{d^4k}{(2\pi)^4} \text{Tr} \left[\frac{i}{\hat{k} + \hat{q} - m + i\epsilon} (-ie\gamma^\mu) \frac{i}{\hat{k} - m + i\epsilon} (-ie\gamma^\nu) \right] \quad (10.7)$$

(the minus sign originates from the fermion loop) and therefore

$$\Pi^{\mu\nu}(q) = i \int \frac{d^4k}{(2\pi)^4} \text{Tr} \left[\frac{1}{\hat{k} + \hat{q} - m} \gamma^\mu \frac{1}{\hat{k} - m + i\epsilon} \gamma^\nu \right] \quad (10.8)$$

The last contribution is

$$\mathcal{M}_d = \bar{u}(p')(-ie)e^2\Lambda^\mu(p', p)u(p)A_\mu^{\text{ext}}(\vec{p}' - \vec{p}) \quad (10.9)$$

where

$$e^2 \Lambda^\mu(p', p) = \int \frac{d^4 k}{(2\pi)^4} (-ie\gamma^\alpha) \frac{i}{\hat{p}' - \hat{k} - m + i\epsilon} \gamma^\mu \frac{i}{\hat{p} - \hat{k} - m + i\epsilon} (-ie\gamma^\beta) \frac{-ig_{\alpha\beta}}{k^2 + i\epsilon} \quad (10.10)$$

or

$$\Lambda^\mu(p', p) = -i \int \frac{d^4 k}{(2\pi)^4} \gamma^\alpha \frac{1}{\hat{p}' - \hat{k} - m + i\epsilon} \gamma^\mu \frac{1}{\hat{p} - \hat{k} - m + i\epsilon} \gamma^\alpha \frac{1}{k^2 + i\epsilon} \quad (10.11)$$

The problem of the divergences is a serious one and in order to give some sense to the theory we have to define a way to define our integrals. This is what is called the regularization procedure of the Feynman integrals. That is we give a prescription in order to make the integrals finite. This can be done in various ways, as introducing an ultraviolet cut-off, or, as we shall see later by the more convenient means of dimensional regularization. However, we want that the theory does not depend on the way in which we define the integrals, otherwise we would have to look for some physical meaning of the regularization procedure we choose. This brings us to the other problem, the inversion of eq. (10.1). Since now the coefficients are finite we can indeed perform the inversion and obtaining e as a function of e_{phys} and obtain all the observables in terms of the physical electric charge (that is the one measured in the Coulomb scattering). By doing so, a priori we will introduce in the observables a dependence on the renormalization procedure. We will say that the theory is renormalizable when this dependence cancels out. Thinking to the regularization in terms of a cut-off this means that considering the observable quantities in terms of e_{phys} , and removing the cut-off (that is by taking the limit for the cut-off going to the infinity), the result should be finite. Of course, this cancellation is not obvious at all, and in fact in most of the theories this does not happen. However there is a restricted class of renormalizable theories, as for instance QED. We will not discuss the renormalization at all order and neither we will prove which criteria a theory should satisfy in order to be renormalizable. We will give these criteria without a proof but we will try only to justify them in a physical basis. As far QED is concerned we will study in detail the renormalization at one-loop.

The previous way of defining a renormalizable theory amounts to say that the original parameters in the lagrangian, as e , should be infinite and that their divergences should compensate the divergences of the Feynman diagrams. Then one can try to separate the infinite from the finite part of the parameters (this separation is ambiguous, see later). The infinite contributions are called counterterms, and by definition they have the same operator structure of the original terms in the lagrangian. On the other hand, the procedure of regularization can be performed by adding to the original lagrangian counterterms cooked in such a way that their contribution kills the divergent part of the Feynman integrals. This means that the coefficients of these counterterms have to be infinite. However they can also be regularized in the same way as the other integrals. We see that the theory will be

renormalizable if the counterterms we add to make the theory finite have the same structure of the original terms in the lagrangian, in fact, if this is the case, they can be absorbed in the original parameters, which however are arbitrary, because they have to be fixed by the experiments (renormalization conditions).

In the case of QED all the divergences can be brought back to the three functions $\Sigma(p)$, $\Pi_{\mu\nu}(q)$ e $\Lambda^\mu(p', p)$. This does not mean that an arbitrary diagram is not divergence, but it can be made finite if the previous functions are such. In such a case one has only to show that eliminating these three divergences (primitive divergences) the theory is automatically finite. In particular we will show that the divergent part of $\Sigma(p)$ can be absorbed into the definition of the mass of the electron and a redefinition of the electron field (wave function renormalization). The divergence in $\Pi_{\mu\nu}$, the photon self-energy, can be absorbed in the wave function renormalization of the photon (the mass of the photon is not renormalized due to the gauge invariance). And finally the divergence of $\Lambda_\mu(p', p)$ goes into the definition of the parameter e . To realize this program we divide up the lagrangian density in two parts, one written in terms of the physical parameters, the other will contain the counterterms. We will call also the original parameters and fields of the theory the bare parameters and the bare fields and we will use an index B in order to distinguish them from the physical quantities. Therefore the two pieces of the lagrangian should look like as follows: the piece in terms of the physical parameters

L_p

$$\mathcal{L}_p = \bar{\psi}(i\hat{\partial} - m)\psi - e\bar{\psi}\gamma_\mu\psi A^\mu - \frac{1}{4}F_{\mu\nu}F^{\mu\nu} - \frac{1}{2}(\partial_\mu A^\mu)^2 \quad (10.12)$$

and the counter terms piece $\mathcal{L}_{c.t.}$

$$\mathcal{L}_{c.t.} = iB\bar{\psi}\hat{\partial}\psi - A\bar{\psi}\psi - \frac{C}{4}F_{\mu\nu}F^{\mu\nu} - \frac{E}{2}(\partial_\mu A^\mu)^2 - eD\bar{\psi}\hat{A}\psi \quad (10.13)$$

and we have to require that la sum of these two contributions should coincide with the original lagrangian written in terms of the bare quantities. Adding together \mathcal{L}_p and $\mathcal{L}_{c.t.}$ we get

$$\mathcal{L} = (1+B)i\bar{\psi}\hat{\partial}\psi - (m+A)\bar{\psi}\psi - e(1+D)\bar{\psi}\gamma_\mu\psi A^\mu - \frac{1+C}{4}F_{\mu\nu}F^{\mu\nu} + \text{gauge - fixing} \quad (10.14)$$

where, for sake of simplicity, we have omitted the gauge fixing term. Defining the renormalization constant of the fields

$$Z_1 = (1+D), \quad Z_2 = (1+B), \quad Z_3 = (1+C) \quad (10.15)$$

we write the bare fields as

$$\psi_B = Z_2^{1/2}\psi, \quad A_B^\mu = Z_3^{1/2}A^\mu \quad (10.16)$$

we obtain

$$\mathcal{L} = i\bar{\psi}_B\hat{\partial}\psi_B - \frac{m+A}{Z_2}\bar{\psi}_B\psi_B - \frac{eZ_1}{Z_2Z_3^{1/2}}\bar{\psi}_B\gamma_\mu\psi_B A_B^\mu - \frac{1}{4}F_{B,\mu\nu}F_B^{\mu\nu} + \text{gauge - fixing} \quad (10.17)$$

and putting

$$m_B = \frac{m + A}{Z_2}, \quad e_B = \frac{eZ_1}{Z_2Z_3^{1/2}} \quad (10.18)$$

we get

$$\mathcal{L} = i\bar{\psi}_B\hat{\partial}\psi_B - m_B\bar{\psi}_B\psi_B - e_B\bar{\psi}_B\gamma_\mu\psi_B A_B^\mu - \frac{1}{4}F_{B,\mu\nu}F_B^{\mu\nu} + \text{gauge} - \text{fixing} \quad (10.19)$$

So we have succeeded in the wanted separation. Notice that the division of the parameters in physical and counter term part is well defined, because the finite piece is fixed to be an observable quantity. This requirement gives the renormalization conditions. The counter terms A , B , ... are determined recursively at each perturbative order in such a way to eliminate the divergent parts and to respect the renormalization conditions. We will see later how this works in practice at one-loop level. Another observation is that Z_1 and Z_2 have to do with the self-energy of the electron, and as such they depend on the electron mass. Therefore if we consider the theory for a different particle, as the muon, which has the same interactions as the electron and differs only for the value of the mass ($m_\mu \approx 200m_e$), one would get a different bare electric charge for the two particles. Or, phrased in a different way, one would have to tune the bare electric charge at different values in order to get the same physical charge. This looks very unnatural, but the gauge invariance of the theory implies that at all the perturbative orders $Z_1 = Z_2$. As a consequence $e_B = e/Z_3^{1/2}$, and since Z_3 comes from the photon self-energy, the relation between the bare and the physical electric charge is universal (that is it does not depend on the kind of charged particle under consideration).

Summarizing, one starts dividing the bare lagrangian in two pieces. Then we regularize the theory giving some prescription to get finite Feynman integrals. The part containing the counter terms is determined, order by order, by requiring that the divergences of the Feynman integrals, which come about when removing the regularization, are cancelled out by the counter term contributions. Since the separation of an infinite quantity into an infinite plus a finite term is not well defined, we use the renormalization conditions, to fix the finite part. After evaluating a physical quantity we remove the regularization. Notice that although the counter terms are divergent quantity when we remove the cut off, we will order them according to the power of the coupling in which we are doing the perturbative calculation. That is we have a double limit, one in the coupling and the other in some parameter (regulator) which defines the regularization. The order of the limit is first to work at some order in the coupling, at fixed regulator, and then remove the regularization.

Before going into the calculations for QED we want to illustrate some general results about the renormalization. If one considers only theory involving scalar, fermion and massless spin 1 (as the photon) fields, it is not difficult to construct an algorithm which allows to evaluate the ultraviolet (that is for large momenta) divergence of any Feynman diagram. In the case of the electron self-energy (see Figs. 10.1a and 10.1b) one has an integration over the four momentum p and a

behaviour of the integrand, coming from the propagators, as $1/p^3$, giving a linear divergence (it turns out that the divergence is only logarithmic). From this counting one can see that only the lagrangian densities containing monomials in the fields with mass dimension smaller or equal to the number of space-time dimensions have a finite number of divergent diagrams. It turns out also that these are renormalizable theories (a part some small technicalities). The mass dimensions of the fields can be easily evaluated from the observation that the action is dimensionless in our units ($\hbar = 1$). Therefore, in n space-time dimensions, the lagrangian density, defined as

$$\int d^n x \mathcal{L} \quad (10.20)$$

has a mass dimension n . Looking at the kinetic terms of the bosonic fields (two derivatives) and of the fermionic fields (one derivative), we see that

$$\dim[\phi] = \dim[A_\mu] = \frac{n}{2} - 1, \quad \dim[\psi] = \frac{n-1}{2} \quad (10.21)$$

In particular, in 4 dimensions the bosonic fields have dimension 1 and the fermionic 3/2. Then, we see that QED is renormalizable, since all the terms in the lagrangian density have dimensions smaller or equal to 4

$$\dim[\bar{\psi}\psi] = 3, \quad \dim[\bar{\psi}\gamma_\mu\psi A^\mu] = 4, \quad \dim[(\partial^\mu A_\mu)^2] = 4 \quad (10.22)$$

The condition on the dimensions of the operators appearing in the lagrangian can be translated into a condition over the coupling constants. In fact each monomial \mathcal{O}_i will appear multiplied by a coupling g_i

$$\mathcal{L} = \sum_i g_i \mathcal{O}_i \quad (10.23)$$

therefore

$$\dim[g_i] = 4 - \dim[\mathcal{O}_i] \quad (10.24)$$

The renormalizability requires

$$\dim[\mathcal{O}_i] \leq 4 \quad (10.25)$$

from which

$$\dim[g_i] \geq 0 \quad (10.26)$$

that is the couplings must have positive dimension in mass are to be dimensionless. In QED the only couplings are the mass of the electron and the electric charge which is dimensionless. As a further example consider a single scalar field. The most general renormalizable lagrangian density is characterized by two parameters

$$\mathcal{L} = \frac{1}{2} \partial_\mu \phi \partial^\mu \phi - \frac{1}{2} m^2 \phi^2 - \rho \phi^3 - \lambda \phi^4 \quad (10.27)$$

Here ρ has dimension 1 and λ is dimensionless. We see that the linear σ -models are renormalizable theories.

Giving these facts let us try to understand what makes renormalizable and non renormalizable theories different. In the renormalizable case, if we have written the most general lagrangian, the only divergent diagrams which appear are the ones corresponding to the processes described by the operators appearing in the lagrangian. Therefore adding to \mathcal{L} the counter term

$$\mathcal{L}_{\text{c.t.}} = \sum_i \delta g_i \mathcal{O}_i \quad (10.28)$$

we can choose the δg_i in such a way to cancel, order by order, the divergences. The theory depends on a finite number of arbitrary parameters equal to the number of parameters g_i . Therefore the theory is a predictive one. In the non renormalizable case, the number of divergent diagrams increase with the perturbative order. At each order we have to introduce new counter terms having an operator structure different from the original one. At the end the theory will depend on an infinite number of arbitrary parameters. As an example consider a fermionic theory with an interaction of the type $(\bar{\psi}\psi)^2$. Since this term has dimension 6, the relative coupling has dimension -2

$$\mathcal{L}_{\text{int}} = -g_2(\bar{\psi}\psi)^2 \quad (10.29)$$

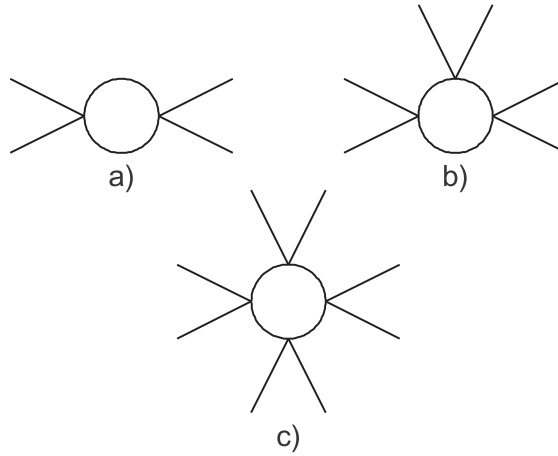

Fig. 10.2 - Divergent diagrams coming from the interaction $(\bar{\psi}\psi)^2$.

At one loop the theory gives rise to the divergent diagrams of Fig. 10.2. The divergence of the first diagram can be absorbed into a counter term of the original type

$$-\delta g_2(\bar{\psi}\psi)^2 \quad (10.30)$$

The other two need counter terms of the type

$$\delta g_3(\bar{\psi}\psi)^3 + \delta g_4(\bar{\psi}\psi)^4 \quad (10.31)$$

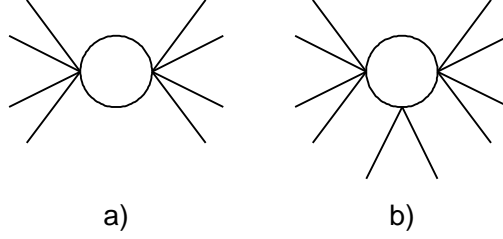

Fig. 10.3 - Divergent diagrams coming from the interactions $(\bar{\psi}\psi)^2$ and $(\bar{\psi}\psi)^4$.

These counter terms originate new one-loop divergent diagrams, as for instance the ones in Fig. 10.3. The first diagram modifies the already introduced counter term $(\bar{\psi}\psi)^4$, but the second one needs a new counter term

$$\delta g_5 (\bar{\psi}\psi)^5 \quad (10.32)$$

This process never ends.

The renormalization requirement restricts in a fantastic way the possible field theories. However one could think that this requirement is too technical and one could imagine other ways of giving a meaning to lagrangians which do not satisfy this condition. But suppose we try to give a meaning to a non renormalizable lagrangian, simply requiring that it gives rise to a consistent theory at any energy. We will show that this does not happen. Consider again a theory with a four-fermion interaction. Since $\dim g_2 = -2$, if we consider the scattering $\psi + \psi \rightarrow \psi + \psi$ in the high energy limit (where we can neglect all the masses), on dimensional ground we get that the total cross-section behaves like

$$\sigma \approx g_2^2 E^2 \quad (10.33)$$

Analogously, in any non renormalizable theory, being there couplings with negative dimensions, the cross-section will increase with the energy. But the cross-section has to do with the S matrix which is unitary. Since a unitary matrix has eigenvalues of modulus 1, it follows that its matrix elements must be bounded. Translating this argument in the cross-section one gets the bound

$$\sigma \leq \frac{c^2}{E^2} \quad (10.34)$$

where c is some constant. For the previous example we get

$$g_2 E^2 \leq c \quad (10.35)$$

This implies a violation of the S matrix unitarity at energies such that

$$E \geq \sqrt{\frac{c}{g_2}} \quad (10.36)$$

It follows that we can give a meaning also to non renormalizable theories, but only for a limited range of values of the energy. This range is fixed by the value of the non renormalizable coupling. It is not difficult to realize that non renormalizability and bad behaviour of the amplitudes at high energies are strictly connected.

10.2 Dimensional regularization of the Feynman integrals

As we have discussed in the previous Section we need a procedure to give sense to the otherwise divergent Feynman diagrams. The simplest of these procedures is just to introduce a cut-off Λ and define our integrals as $\int_0^\infty \rightarrow \lim_{\Lambda \rightarrow \infty} \int_0^\Lambda$. Of course, in the spirit of renormalization we have first to perform the perturbative expansion and then take the limit over the cut-off. Although this procedure is very simple it results to be inadequate in situations like gauge theories. In fact one can show that the cut-off regularization breaks the translational invariance and creates problems in gauge theories. One kind of regularization which nowadays is very much used is the dimensional regularization. This consists in considering the integration in an arbitrary number of space-time dimensions and taking the limit of four dimensions at the end. This way of regularizing is very convenient because it respects all the symmetries. In fact, except for very few cases the symmetries do not depend on the number of space-time dimensions. Let us see what is dimensional regularization about. We want to evaluate integrals of the type

$$I_4(k) = \int d^4p F(p, k) \quad (10.37)$$

with $F(p, k) \approx p^{-2}$ or p^{-4} . The idea is that integrating on a lower number of dimensions the integral improves the convergence properties in the ultraviolet. For instance, if $F(p, k) \approx p^{-4}$, the integral is convergent in 2 and in 3 dimensions. Therefore, we would like to introduce a quantity

$$I(\omega, k) = \int d^{2\omega}p F(p, k) \quad (10.38)$$

to be regarded as a function of the complex variable ω . Then, if we can define a complex function $I'(\omega, k)$ on the entire complex plane, with definite singularity, and as such that it coincides with I on some common domain, then by analytic continuation I and I' define the same analytic function. A simple example of this procedure is given by the Euler's Γ . This complex function is defined for $\text{Re } z > 0$ by the integral representation

$$\Gamma(z) = \int_0^\infty dt e^{-t} t^{z-1} \quad (10.39)$$

If $\text{Re } z \leq 0$, the integral diverges as

$$\frac{dt}{t^{1+|\text{Re } z|}} \quad (10.40)$$

in the limit $t \rightarrow 0$. However it is easy to get a representation valid also for $Re z \leq 0$. Let us divide the integration region in two parts defined by a parameter α

$$\Gamma(z) = \int_0^\alpha dt e^{-t} t^{z-1} + \int_\alpha^\infty dt e^{-t} t^{z-1} \quad (10.41)$$

Expanding the exponential in the first integral and integrating term by term we get

$$\begin{aligned} \Gamma(z) &= \sum_{n=0}^{\infty} \frac{(-1)^n}{n!} \int_0^\alpha dt t^{n+z-1} + \int_\alpha^\infty dt e^{-t} t^{z-1} \\ &= \sum_{n=0}^{\infty} \frac{(-1)^n}{n!} \frac{\alpha^{n+z}}{n+z} + \int_\alpha^\infty dt e^{-t} t^{z-1} \end{aligned} \quad (10.42)$$

The second integral converges for any z since $\alpha > 0$. This expression coincides with the representation for the Γ function for $Re z > 0$, but it is defined also for $Re z < 0$ where it has simple poles located at $z = -n$. Therefore it is a meaningful expression on all the complex plane z . Notice that in order to isolate the divergences we need to introduce an arbitrary parameter α . However the result does not depend on the particular value of this parameter. This is the Weierstrass representation of the Euler $\Gamma(z)$. From this example we see that we need the following three steps

- Find a domain where $I(\omega, k)$ is convergent. Typically this will be for $Re \omega < 2$.
- Construct an analytic function identical to $I(\omega, k)$ in the domain of convergence, but defined on a larger domain including the point $\omega = 2$.
- At the end of the calculation take the limit $\omega \rightarrow 2$.

10.3 Integration in arbitrary dimensions

Let us consider the integral

$$I_N = \int d^N p F(p^2) \quad (10.43)$$

with N an integer number and p a vector in an Euclidean N -dimensional space. Since the integrand is invariant under rotations of the N -dimensional vector p , we can perform the angular integration by means of

$$d^N p = d\Omega_N p^{N-1} dp \quad (10.44)$$

where $d\Omega_N$ is the solid angle element in N -dimensions. Therefore $\int d\Omega_N = S_N$, with S_N the surface of the unit sphere in N -dimensions. Then

$$I_N = S_N \int_0^\infty p^{N-1} F(p^2) dp \quad (10.45)$$

The value of the sphere surface can be evaluated by the following trick. Consider

$$I = \int_{-\infty}^{+\infty} e^{-x^2} dx = \sqrt{\pi} \quad (10.46)$$

By taking N of these factors we get

$$I^N = \int dx_1 \cdots dx_N e^{-(x_1^2 + \cdots + x_N^2)} = \pi^{N/2} \quad (10.47)$$

The same integral can be evaluated in polar coordinates

$$\pi^{N/2} = S_N \int_0^\infty \rho^{N-1} e^{-\rho^2} d\rho \quad (10.48)$$

By putting $x = \rho^2$ we have

$$\pi^{N/2} = \frac{1}{2} S_N \int_0^\infty x^{N/2-1} e^{-x} dx = \frac{1}{2} S_N \Gamma\left(\frac{N}{2}\right) \quad (10.49)$$

where we have used the representation of the Euler Γ function given in the previous Section. Therefore

$$S_N = \frac{2\pi^{N/2}}{\Gamma\left(\frac{N}{2}\right)} \quad (10.50)$$

and

$$I_N = \frac{\pi^{N/2}}{\Gamma\left(\frac{N}{2}\right)} \int_0^\infty x^{N/2-1} F(x) dx \quad (10.51)$$

with $x = p^2$.

The integrals we will be interested in are of the type

$$I_N^{(M)} = \int \frac{d^N p}{(p^2 - a^2 + i\epsilon)^A} \quad (10.52)$$

with p a vector in a N dimensional Minkowski space. We can perform an anti-clockwise rotation of 90° (Wick's rotation) in the complex plane of p_0 without hitting any singularity. Then we do a change of variables $p_0 \rightarrow ip_0$ obtaining

$$I_N^{(M)} = i \int \frac{d^N p}{(-p^2 - a^2)^A} = i(-1)^A I_N \quad (10.53)$$

where I_N is an Euclidean integral of the kind discussed at the beginning of this Section with $F(x)$ given by

$$F(x) = (x + a^2)^{-A} \quad (10.54)$$

It follows

$$I_N = \frac{\pi^{N/2}}{\Gamma\left(\frac{N}{2}\right)} \int_0^\infty \frac{x^{N/2-1}}{(x + a^2)^A} dx \quad (10.55)$$

By putting $x = a^2 y$ we get

$$I_N = (a^2)^{N/2-A} \frac{\pi^{N/2}}{\Gamma\left(\frac{N}{2}\right)} \int_0^\infty y^{N/2-1} (1 + y)^{-A} dy \quad (10.56)$$

and recalling the integral representation for the Euler $B(x, y)$ function (valid for $Re x, y > 0$)

$$B(x, y) = \frac{\Gamma(x)\Gamma(y)}{\Gamma(x+y)} = \int_0^\infty t^{x-1}(1+t)^{-(x+y)} dt \quad (10.57)$$

it follows

$$I_N = \pi^{N/2} \frac{\Gamma(A - N/2)}{\Gamma(A)} \frac{1}{(a^2)^{A-N/2}} \quad (10.58)$$

We have obtained this representation for $N/2 > 0$ and $Re(A - N/2) > 0$. But we know how to extend the Euler gamma-function to the entire complex plane, and therefore we can extend this formula to complex dimensions $N = 2\omega$

$$I_{2\omega} = \pi^\omega \frac{\Gamma(A - \omega)}{\Gamma(A)} \frac{1}{(a^2)^{A-\omega}} \quad (10.59)$$

This shows that $I_{2\omega}$ has simple poles located at

$$\omega = A, A + 1, \dots \quad (10.60)$$

Therefore our integral will be perfectly defined at all ω such that $\omega \neq A, A + 1, \dots$. At the end we will have to consider the limit $\omega \rightarrow 2$. The original integral in Minkowski space is then

$$\int \frac{d^{2\omega} p}{(p^2 - a^2)^A} = i\pi^\omega (-1)^A \frac{\Gamma(A - \omega)}{\Gamma(A)} \frac{1}{(a^2)^{A-\omega}} \quad (10.61)$$

For the following it will be useful to derive another formula. Let us put in the previous equation $p = p' + k$ and $b^2 = -a^2 + k^2$, then

$$\int \frac{d^{2\omega} p'}{(p'^2 + 2p' \cdot k + k^2 - a^2)^A} = i\pi^\omega (-1)^A \frac{\Gamma(A - \omega)}{\Gamma(A)} \frac{1}{(a^2)^{A-\omega}} \quad (10.62)$$

from which

$$\int \frac{d^{2\omega} p}{(p^2 + 2p \cdot k + b^2)^A} = i\pi^\omega (-1)^A \frac{\Gamma(A - \omega)}{\Gamma(A)} \frac{1}{(k^2 - b^2)^{A-\omega}} \quad (10.63)$$

Differentiating with respect to k_μ we get various useful relations as

$$\int d^{2\omega} p \frac{p_\mu}{(p^2 + 2p \cdot k + b^2)^A} = i\pi^\omega (-1)^A \frac{\Gamma(A - \omega)}{\Gamma(A)} \frac{-k_\mu}{(k^2 - b^2)^{A-\omega}} \quad (10.64)$$

and

$$\begin{aligned} \int d^{2\omega} p \frac{p_\mu p_\nu}{(p^2 + 2p \cdot k + b^2)^A} &= i \frac{\pi^\omega (-1)^A}{\Gamma(A) (k^2 - b^2)^{A-\omega}} \\ &\times \left[\Gamma(A - \omega) k_\mu k_\nu - \frac{1}{2} g_{\mu\nu} (k^2 - b^2) \Gamma(A - \omega - 1) \right] \end{aligned} \quad (10.65)$$

Since at the end of our calculation we will have to take the limit $\omega \rightarrow 2$, it will be useful to recall the expansion of the Gamma function around its poles

$$\Gamma(\epsilon) = \frac{1}{\epsilon} - \gamma + \mathcal{O}(\epsilon) \quad (10.66)$$

where

$$\gamma = 0.5772\dots \quad (10.67)$$

is the Euler-Mascheroni constant, and for ($n \geq 1$):

$$\Gamma(-n + \epsilon) = \frac{(-1)^n}{n!} \left[\frac{1}{\epsilon} + \psi(n + 1) + \mathcal{O}(\epsilon) \right] \quad (10.68)$$

where

$$\psi(n + 1) = 1 + \frac{1}{2} + \dots + \frac{1}{n} - \gamma \quad (10.69)$$

10.4 One loop regularization of QED

In this Section we will regularize, by using dimensional regularization, the relevant divergent quantities in QED, that is $\Sigma(p)$, $\Pi_{\mu\nu}(q)$ e $\Lambda^\mu(p, p')$. Furthermore, in order to define the counter terms we will determine the expressions which become divergent in the limit of $\omega \rightarrow 2$. It will be also convenient to introduce a parameter μ such that these quantities have the same dimensions in the space with $d = 2\omega$ as in $d = 4$. The algebra of the Dirac matrices is also easily extended to arbitrary dimensions d . For instance, starting from

$$[\gamma_\mu, \gamma_\nu]_+ = 2g_{\mu\nu} \quad (10.70)$$

we get

$$\gamma^\mu \gamma_\mu = d \quad (10.71)$$

and

$$\gamma_\mu \gamma_\nu \gamma^\mu = (2 - d)\gamma_\nu \quad (10.72)$$

Other relations can be obtained by starting from the algebraic properties of the γ -matrices. Let us start with the electron self-energy which we will require to have dimension 1 as in $d = 4$. From eq. (10.4) we have

$$\Sigma(p) = i\mu^{4-2\omega} \int \frac{d^{2\omega}k}{(2\pi)^{2\omega}} \gamma_\mu \frac{\hat{p} - \hat{k} + m}{(p - k)^2 - m^2 + i\epsilon} \gamma^\mu \frac{1}{k^2 + i\epsilon} \quad (10.73)$$

In order to use the equations of the previous Section it is convenient to combine together the denominators of this expression into a single one. This is done by using a formula due to Feynman

$$\frac{1}{ab} = \int_0^1 \frac{dz}{[az + b(1 - z)]^2} \quad (10.74)$$

which is proven using

$$\frac{1}{ab} = \frac{1}{b-a} \left[\frac{1}{a} - \frac{1}{b} \right] = \frac{1}{b-a} \int_a^b \frac{dx}{x^2} \quad (10.75)$$

and doing the change of variables

$$x = az + b(1-z) \quad (10.76)$$

We get

$$\Sigma(p) = i\mu^{4-2\omega} \int_0^1 dz \int \frac{d^{2\omega}k}{(2\pi)^{2\omega}} \gamma_\mu \frac{\hat{p} - \hat{k} + m}{[(p-k)^2 z - m^2 z + k^2(1-z)]^2} \gamma^\mu \quad (10.77)$$

The denominator can be written in the following way

$$[...] = p^2 z - m^2 z + k^2 - 2p \cdot kz \quad (10.78)$$

and the term $p \cdot k$ can be eliminated through the following change of variables $k = k' + pz$. We find

$$[...] = (p^2 - m^2)z + (k' + pz)^2 - 2p \cdot (k' + pz)z = k'^2 - m^2 z + p^2 z(1-z) \quad (10.79)$$

It follows (we put $k' = k$)

$$\Sigma(p) = i\mu^{4-2\omega} \int_0^1 dz \int \frac{d^{2\omega}k}{(2\pi)^{2\omega}} \gamma_\mu \frac{\hat{p}(1-z) - \hat{k} + m}{[k^2 - m^2 z + p^2 z(1-z)]^2} \gamma^\mu \quad (10.80)$$

The linear term in k has vanishing integral, therefore

$$\Sigma(p) = i\mu^{4-2\omega} \int_0^1 dz \int \frac{d^{2\omega}k}{(2\pi)^{2\omega}} \gamma_\mu \frac{\hat{p}(1-z) + m}{[k^2 - m^2 z + p^2 z(1-z)]^2} \gamma^\mu \quad (10.81)$$

and integrating over k

$$\Sigma(p) = i\mu^{4-2\omega} \int_0^1 dz \frac{1}{(2\pi)^{2\omega}} i\pi^\omega \frac{\Gamma(2-\omega)}{\Gamma(2)} \gamma_\mu \frac{\hat{p}(1-z) + m}{[m^2 z - p^2 z(1-z)]^{2-\omega}} \gamma^\mu \quad (10.82)$$

By defining $\epsilon = 4 - 2\omega$ we get

$$\Sigma(p) = -\mu^\epsilon \int_0^1 dz \frac{1}{(2\pi)^{4-\epsilon}} \pi^{(4-\epsilon)/2} \Gamma(\epsilon/2) \gamma_\mu \frac{\hat{p}(1-z) + m}{[m^2 z - p^2 z(1-z)]^{\epsilon/2}} \gamma^\mu \quad (10.83)$$

Contracting the γ matrices

$$\Sigma(p) = -\frac{1}{16\pi^2} \Gamma(\epsilon/2) \int_0^1 dz (4\pi\mu^2)^{\epsilon/2} \frac{(\epsilon-2)\hat{p}(1-z) + (4-\epsilon)m}{[m^2 z - p^2 z(1-z)]^{\epsilon/2}} \quad (10.84)$$

we obtain

$$\begin{aligned} \Sigma(p) &= \frac{1}{16\pi^2} \Gamma(\epsilon/2) \\ &\times \int_0^1 dz [2\hat{p}(1-z) - 4m - \epsilon(\hat{p}(1-z) - m)] \left[\frac{m^2 z - p^2 z(1-z)}{4\pi\mu^2} \right]^{-\epsilon/2} \end{aligned} \quad (10.85)$$

Defining

$$A = 2\hat{p}(1-z) - 4m, \quad B = -\hat{p}(1-z) + m, \quad C = \frac{m^2 z - p^2 z(1-z)}{4\pi\mu^2} \quad (10.86)$$

and expanding for $\epsilon \rightarrow 0$

$$\begin{aligned} \Sigma(p) &= \frac{1}{16\pi^2} \int_0^1 dz \left[\frac{2A}{\epsilon} + 2B - \gamma A \right] \left[1 - \frac{\epsilon}{2} \log C \right] \\ &= \frac{1}{16\pi^2} \int_0^1 dz \left[\frac{2A}{\epsilon} - A \log C + 2B - \gamma A \right] \\ &= \frac{1}{8\pi^2 \epsilon} (\hat{p} - 4m) - \frac{1}{16\pi^2} [\hat{p} - 2m + \gamma(\hat{p} - 4m)] \\ &\quad - \frac{1}{8\pi^2} \int_0^1 dz [\hat{p}(1-z) - 2m] \log \frac{m^2 z - p^2 z(1-z)}{4\pi\mu^2} \\ &= \frac{1}{8\pi^2 \epsilon} (\hat{p} - 4m) + \text{finite terms} \end{aligned} \quad (10.87)$$

Consider now the vacuum polarization (see eq. (10.8))

$$\begin{aligned} \Pi^{\mu\nu}(q) &= i\mu^{4-2\omega} \int \frac{d^{2\omega} k}{(2\pi)^{2\omega}} \text{Tr} \left[\frac{1}{\hat{k} + \hat{q} - m} \gamma^\mu \frac{1}{\hat{k} - m} \gamma^\nu \right] \\ &= i\mu^{4-2\omega} \int \frac{d^{2\omega} k}{(2\pi)^{2\omega}} \frac{\text{Tr}[\gamma_\mu(\hat{k} + m)\gamma_\nu(\hat{k} + \hat{q} + m)]}{(k^2 - m^2)((k+q)^2 - m^2)} \end{aligned} \quad (10.88)$$

Using again the Feynman representation for the denominators

$$\Pi^{\mu\nu}(q) = i\mu^{4-2\omega} \int_0^1 dz \int \frac{d^{2\omega} k}{(2\pi)^{2\omega}} \frac{\text{Tr}[\gamma_\mu(\hat{k} + m)\gamma_\nu(\hat{k} + \hat{q} + m)]}{[(k^2 - m^2)(1-z) + ((k+q)^2 - m^2)z]^2} \quad (10.89)$$

We write the denominator as

$$[\dots] = k^2 + q^2 z - m^2 + 2k \cdot qz \quad (10.90)$$

through the change of variable $k = k' - qz$ we cancel the mixed term obtaining

$$[\dots] = (k' - qz)^2 + 2(k' - qz) \cdot qz + q^2 z - m^2 = k'^2 + q^2 z(1-z) - m^2 \quad (10.91)$$

and therefore (we put again $k' = k$)

$$\Pi^{\mu\nu}(q) = i\mu^{4-2\omega} \int_0^1 dz \int \frac{d^{2\omega} k}{(2\pi)^{2\omega}} \frac{\text{Tr}[\gamma_\mu(\hat{k} - \hat{q}z + m)\gamma_\nu(\hat{k} + \hat{q}(1-z) + m)]}{[k^2 + q^2 z(1-z) - m^2]^2} \quad (10.92)$$

Since the integral of the odd terms in k is zero, it is enough to evaluate the contribution of the even term to the trace

$$\begin{aligned} Tr[\dots]_{\text{even}} &= Tr[\gamma_\mu(\hat{k} - \hat{q}z + m)\gamma_\nu(\hat{k} + \hat{q}(1-z))]_{\text{pari}} + m^2 Tr[\gamma_\mu\gamma_\nu] \\ &= Tr[\gamma_\mu\hat{k}\gamma_\nu\hat{k}] - Tr[\gamma_\mu\hat{q}\gamma_\nu\hat{q}]z(1-z) + m^2 Tr[\gamma_\mu\gamma_\nu] \end{aligned} \quad (10.93)$$

If we define the γ as matrices of dimension $2^\omega \times 2^\omega$ we can repeat the calculation of Section 9.2 obtaining a factor 2^ω instead of 4. Therefore

$$\begin{aligned} Tr[\dots]_{\text{even}} &= 2^\omega [2k_\mu k_\nu - g_{\mu\nu}k^2 - (2q_\mu q_\nu - g_{\mu\nu}q^2)z(1-z) + m^2 g_{\mu\nu}] \\ &= 2^\omega [2k_\mu k_\nu - 2z(1-z)(q_\mu q_\nu - g_{\mu\nu}q^2) - g_{\mu\nu}(k^2 - m^2 + q^2z(1-z))] \end{aligned} \quad (10.94)$$

and we find

$$\begin{aligned} \Pi^{\mu\nu}(q) &= i\mu^{4-2\omega}2^\omega \int_0^1 dz \int \frac{d^{2\omega}k}{(2\pi)^{2\omega}} \left[\frac{2k_\mu k_\nu}{[k^2 + q^2z(1-z) - m^2]^2} \right. \\ &\quad \left. - \frac{2z(1-z)(q_\mu q_\nu - g_{\mu\nu}q^2)}{[k^2 + q^2z(1-z) - m^2]^2} - \frac{g_{\mu\nu}}{[k^2 + q^2z(1-z) - m^2]} \right] \end{aligned} \quad (10.95)$$

From the relations of the previous Section we get

$$\int d^{2\omega}p \frac{2p_\mu p_\nu}{[p^2 - a^2]^2} = -ig_{\mu\nu}\pi^\omega \frac{\Gamma(1-\omega)}{(a^2)^{1-\omega}} \quad (10.96)$$

whereas

$$\int d^{2\omega}p \frac{1}{[p^2 - a^2]} = -i\pi^\omega \frac{\Gamma(1-\omega)}{(a^2)^{1-\omega}} \quad (10.97)$$

Therefore the first and the third contribution to the vacuum polarization cancel out and we are left with

$$\Pi^{\mu\nu}(q) = -i\mu^{4-2\omega}2^\omega (q_\mu q_\nu - g_{\mu\nu}q^2) \int_0^1 dz 2z(1-z) \int \frac{d^{2\omega}k}{(2\pi)^{2\omega}} \frac{1}{[k^2 + q^2z(1-z) - m^2]^2} \quad (10.98)$$

Notice that the original integral was quadratically divergent, but due to the previous cancellation the divergence is only logarithmic. The reason is again gauge invariance. In fact it is possible to show that this implies $q^\mu \Pi_{\mu\nu}(q) = 0$. Performing the momentum integration we have

$$\Pi^{\mu\nu}(q) = -i2\mu^{4-2\omega}2^\omega (q_\mu q_\nu - g_{\mu\nu}q^2) \int_0^1 dz z(1-z) \frac{i\pi^\omega}{(2\pi)^{2\omega}} \frac{\Gamma(2-\omega)}{[m^2 - q^2z(1-z)]^{2-\omega}} \quad (10.99)$$

By putting again $\epsilon = 4 - 2\omega$ and expanding the previous expression

$$\Pi^{\mu\nu}(q) = 2\mu^\epsilon 2^{2-\epsilon/2} (q_\mu q_\nu - g_{\mu\nu}q^2) \int_0^1 dz z(1-z) \frac{\pi^{2-\epsilon/2}}{(2\pi)^{4-\epsilon}} \frac{\Gamma(\epsilon/2)}{[m^2 - q^2z(1-z)]^{\epsilon/2}}$$

$$\begin{aligned}
&= \frac{2}{16\pi^2} 2^{2-\epsilon/2} (q_\mu q_\nu - g_{\mu\nu} q^2) \int_0^1 dz z(1-z) \Gamma(\epsilon/2) \left[\frac{m^2 - q^2 z(1-z)}{4\pi\mu^2} \right]^{-\epsilon/2} \\
&= \frac{2}{16\pi^2} (4 - 2\epsilon \log 2) (q_\mu q_\nu - g_{\mu\nu} q^2) \\
&\times \int_0^1 dz z(1-z) \left(\frac{2}{\epsilon} - \gamma \right) \left[1 - \frac{\epsilon}{2} \log C \right]
\end{aligned} \tag{10.100}$$

where C is definite in eq. (10.86). Finally

$$\begin{aligned}
\Pi_{\mu\nu}(q) &= \frac{1}{8\pi^2} (q_\mu q_\nu - g_{\mu\nu} q^2) \int dz z(1-z) \left[\frac{8}{\epsilon} - 4\gamma - 4 \log 2 \right] \left[1 - \frac{\epsilon}{2} \log C \right] \\
&= \frac{1}{2\pi^2} (q_\mu q_\nu - g_{\mu\nu} q^2) \\
&\times \left[\frac{1}{3\epsilon} - \frac{\gamma}{6} - \int dz z(1-z) \log \left[\frac{m^2 - q^2 z(1-z)}{2\pi\mu^2} \right] \right]
\end{aligned} \tag{10.101}$$

or, in abbreviated way

$$\Pi_{\mu\nu}(q) = \frac{1}{6\pi^2} (q_\mu q_\nu - g_{\mu\nu} q^2) \frac{1}{\epsilon} + \text{finite terms} \tag{10.102}$$

We have now to evaluate $\Lambda_\mu(p', p)$. From eq. (10.11) we have

$$\Lambda^\mu(p', p) = -i\mu^{4-2\omega} \int \frac{d^{2\omega} k}{(2\pi)^{2\omega}} \gamma^\alpha \frac{\hat{p}' - \hat{k} + m}{(p' - k)^2 - m^2} \gamma^\mu \frac{\hat{p} - \hat{k} + m}{(p - k)^2 - m^2} \gamma^\alpha \frac{1}{k^2} \tag{10.103}$$

the general formula to reduce n denominators to a single one is

$$\prod_{i=1}^n \frac{1}{a_i} = (n-1)! \int_0^1 \prod_{i=1}^n d\beta_i \frac{\delta(1 - \sum_{i=1}^n \beta_i)}{[\sum_{i=1}^n \beta_i a_i]^n} \tag{10.104}$$

To show this equation notice that

$$\prod_{i=1}^n \frac{1}{a_i} = \int_0^\infty \prod_{i=1}^n d\alpha_i e^{-\sum_{i=1}^n \alpha_i a_i} \tag{10.105}$$

Introducing the identity

$$1 = \int_0^\infty d\lambda \delta(\lambda - \sum_{i=1}^n \alpha_i) \tag{10.106}$$

and changing variables $\alpha_i = \lambda\beta_i$

$$\prod_{i=1}^n \frac{1}{a_i} = \int_0^\infty \prod_{i=1}^n d\alpha_i d\lambda \delta(\lambda - \sum_{i=1}^n \alpha_i) e^{-\sum_{i=1}^n \alpha_i a_i} = \int_0^\infty \prod_{i=1}^n d\beta_i \lambda^n \frac{d\lambda}{\lambda} e^{-\lambda \sum_{i=1}^n \beta_i a_i} \tag{10.107}$$

The integration over β_i can be restricted to the interval $[0, 1]$ due to the delta function, and furthermore

$$\int_0^\infty d\lambda \lambda^{n-1} e^{-\rho\lambda} = \frac{(n-1)!}{\rho^n} \quad (10.108)$$

In our case we get

$$\begin{aligned} \Lambda^\mu(p', p) &= -2i\mu^{4-2\omega} \int \frac{d^{2\omega}k}{(2\pi)^{2\omega}} \int_0^1 dx \int_0^{1-x} dy \\ &\times \frac{\gamma^\alpha(\hat{p}' - \hat{k} + m)\gamma^\mu(\hat{p} - \hat{k} + m)\gamma_\alpha}{[k^2(1-x-y) + (p-k)^2x - m^2x + (p'-k)^2y - m^2y]^3} \end{aligned} \quad (10.109)$$

The denominator is

$$[...] = k^2 - m^2(x+y) + p^2x + p'^2y - 2k \cdot (px + p'y) \quad (10.110)$$

Changing variable, $k = k' + px + py$

$$\begin{aligned} [...] &= (k' + px + p'y)^2 - m^2(x+y) + p^2x + p'^2y - 2(k' + px + p'y) \cdot (px + p'y) \\ &= k'^2 - m^2(x+y) + p^2x(1-x) + p'^2y(1-y) - 2p \cdot p'xy \end{aligned} \quad (10.111)$$

Letting again $k' \rightarrow k$

$$\begin{aligned} \Lambda^\mu(p', p) &= -2i\mu^{4-2\omega} \int_0^1 dx \int_0^{1-x} dy \int \frac{d^{2\omega}k}{(2\pi)^{2\omega}} \\ &\times \frac{\gamma^\alpha(\hat{p}'(1-y) - \hat{p}x - \hat{k} + m)\gamma^\mu(\hat{p}(1-x) - \hat{p}'y - \hat{k} + m)\gamma_\alpha}{[k^2 - m^2(x+y) + p^2x(1-x) + p'^2y(1-y) - 2p \cdot p'xy]^3} \end{aligned} \quad (10.112)$$

The odd term in k is zero after integration, the term in k^2 is logarithmically divergent, whereas the remaining part is convergent. Separating the divergent piece, $\Lambda_\mu^{(1)}$, from the convergent one, $\Lambda_\mu^{(3)}$,

$$\Lambda_\mu = \Lambda_\mu^{(1)} + \Lambda_\mu^{(2)} \quad (10.113)$$

we get for the first term

$$\begin{aligned} \Lambda_\mu^{(1)}(p', p) &= -2i\mu^{4-2\omega} \int_0^1 dx \int_0^{1-x} dy \int \frac{d^{2\omega}k}{(2\pi)^{2\omega}} \\ &\quad \frac{k^\lambda k^\sigma}{\gamma^\alpha \gamma_\lambda \gamma_\mu \gamma_\sigma \gamma_\alpha [k^2 - m^2(x+y) + p^2x(1-x) + p'^2y(1-y) - 2p \cdot p'xy]^3} \\ &= -2i\mu^{4-2\omega} \int_0^1 dx \int_0^{1-x} dy \frac{i\pi^\omega (-1)^3}{\Gamma(3)} \left(-\frac{1}{2}\right) \Gamma(2-\omega) \\ &\quad \frac{\gamma^\alpha \gamma_\lambda \gamma^\mu \gamma^\lambda \gamma_\alpha}{[m^2(x+y) - p^2x(1-x) - p'^2y(1-y) + 2p \cdot p'xy]^{2-\omega}} \\ &= \frac{1}{2} \mu^{4-2\omega} \left(\frac{1}{4\pi}\right)^\omega \Gamma(2-\omega) \int_0^1 dx \int_0^{1-x} dy \\ &\quad \frac{\gamma^\alpha \gamma_\lambda \gamma^\mu \gamma^\lambda \gamma_\alpha}{[m^2(x+y) - p^2x(1-x) - p'^2y(1-y) + 2p \cdot p'xy]^{2-\omega}} \end{aligned} \quad (10.114)$$

Using the relation

$$\gamma^\alpha \gamma_\lambda \gamma^\mu \gamma^\lambda \gamma_\alpha = (2-d)^2 \gamma^\mu \quad (10.115)$$

we obtain ($\epsilon = 4 - 2\omega$)

$$\begin{aligned} \Lambda_\mu^{(1)}(p', p) &= \frac{1}{2} \mu^\epsilon \left(\frac{1}{4\pi} \right)^{2-\epsilon/2} \Gamma(\epsilon/2) (\epsilon-2)^2 \gamma_\mu \int_0^1 dx \int_0^{1-x} dy \\ &\quad \frac{1}{[m^2(x+y) - p^2x(1-x) - p'^2y(1-y) + 2p \cdot p'xy]^{\epsilon/2}} \\ &= \frac{1}{32\pi^2} \left[\frac{2}{\epsilon} - \gamma \right] [4 - 4\epsilon] \gamma_\mu \int_0^1 dx \int_0^{1-x} dy \\ &\quad \left[\frac{m^2(x+y) - p^2x(1-x) - p'^2y(1-y) + 2p \cdot p'xy}{4\pi\mu^2} \right]^{-\epsilon/2} \\ &= \frac{1}{8\pi^2\epsilon} \gamma_\mu - \frac{1}{16\pi^2} (\gamma+2) \gamma_\mu - \frac{1}{8\pi^2} \gamma_\mu \int_0^1 dx \int_0^{1-x} dy \\ &\quad \times \log \left[\frac{m^2(x+y) - p^2x(1-x) - p'^2y(1-y) + 2p \cdot p'xy}{4\pi\mu^2} \right] \end{aligned} \quad (10.116)$$

and finally

$$\Lambda_\mu^{(1)}(p', p) = \frac{1}{8\pi^2\epsilon} \gamma_\mu + \text{finite terms} \quad (10.117)$$

In the convergent part we can put directly $\omega = 2$

$$\begin{aligned} \Lambda_\mu^{(2)}(p', p) &= -\frac{i}{8\pi^4} \int_0^1 dx \int_0^{1-x} dy \frac{i\pi^2(-1)^3}{\Gamma(3)} \\ &\quad \frac{\gamma^\alpha (\hat{p}'(1-y) - \hat{p}x + m) \gamma^\mu (\hat{p}(1-x) - \hat{p}'y + m) \gamma_\alpha}{m^2(x+y) - p^2x(1-x) - p'^2y(1-y) + 2p \cdot p'xy} \\ &= -\frac{1}{16\pi^2} \int_0^1 dx \int_0^{1-x} dy \\ &\quad \frac{\gamma^\alpha (\hat{p}'(1-y) - \hat{p}x + m) \gamma^\mu (\hat{p}(1-x) - \hat{p}'y + m) \gamma_\alpha}{m^2(x+y) - p^2x(1-x) - p'^2y(1-y) + 2p \cdot p'xy} \end{aligned} \quad (10.118)$$

10.5 One loop renormalization

We summarize here the results of the previous Section

$$\Sigma(p) = \frac{1}{8\pi^2\epsilon} (\hat{p} - 4m) + \Sigma^f(p). \quad (10.119)$$

$$\Pi_{\mu\nu}(q) = (q_\mu q_\nu - g_{\mu\nu} q^2) \left[\frac{1}{6\pi^2\epsilon} + \Pi^f(q) \right] \equiv (q_\mu q_\nu - g_{\mu\nu} q^2) \Pi(q^2). \quad (10.120)$$

$$\Lambda_\mu(p', p) = \frac{1}{8\pi^2\epsilon} \gamma_\mu + \Lambda_\mu^f(p', p), \quad (10.121)$$

where the functions with the superscript f represent the finite contributions. Let us start discussing the electron self-energy. As shown in eq. (10.2), the effect of $\Sigma(p)$ is to correct the electron propagator. In fact we have (see Fig. 10.4):

$$S_F(p) = \frac{i}{\hat{p} - m} + \frac{i}{\hat{p} - m} ie^2 \Sigma(p) \frac{i}{\hat{p} - m} + \dots, \quad (10.122)$$

from which, at the same order in the perturbative expansion

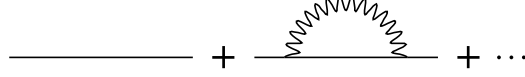

Fig. 10.4 - The loop expansion for the electron propagator.

$$S_F(p) = \frac{i}{\hat{p} - m} \left(1 + \frac{e^2 \Sigma(p)}{\hat{p} - m} \right)^{-1} = \frac{i}{\hat{p} - m + e^2 \Sigma(p)}. \quad (10.123)$$

Therefore the effect of the divergent terms is to modify the coefficients of \hat{p} and m :

$$iS_F^{-1}(p) = \hat{p} - m + e^2 \Sigma(p) = \hat{p} \left(1 + \frac{e^2}{8\pi^2 \epsilon} \right) - m \left(1 + \frac{e^2}{2\pi^2 \epsilon} \right) + \text{finite terms}. \quad (10.124)$$

This allows us to define the counterterms to be added to the Lagrangian expressed in terms of the physical parameters in such a way to cancel these divergences

$$(\mathcal{L}_1)_{ct} = iB\bar{\psi}\hat{\partial}\psi - A\bar{\psi}\psi, \quad (10.125)$$

$(\mathcal{L}_1)_{ct}$ modifies the Feynman rules adding two operators parameterized by A and B . These coefficients can be evaluated noticing that the expression of the propagator, taking into account $(\mathcal{L}_1)_{ct}$, is

$$\begin{aligned} \frac{i}{(1+B)\hat{p} - (m+A)} &\approx \frac{i}{\hat{p} - m} \left(1 - \frac{B\hat{p} - A}{\hat{p} - m} \right) \\ &\approx \frac{i}{\hat{p} - m} + \frac{i}{\hat{p} - m} (iB\hat{p} - iA) \frac{i}{\hat{p} - m}, \end{aligned} \quad (10.126)$$

where, consistently with our expansion we have taken only the first order terms in A and B . We can associate to these two terms the diagrams of Fig. 10.5, with contributions $-iA$ to the mass term, and $iB\hat{p}$ to \hat{p} .

The propagator at the second order in the coupling constant is then obtained by adding the diagrams of Fig. 10.6 to the free part. We get

$$S_F(p) = \frac{i}{\hat{p} - m} + \frac{i}{\hat{p} - m} \left(ie^2 \Sigma(p) + iB\hat{p} - iA \right) \frac{i}{\hat{p} - m} \quad (10.127)$$



Fig. 10.5 - The counter terms for the self-energy (p in the figure should be read as \hat{p}).

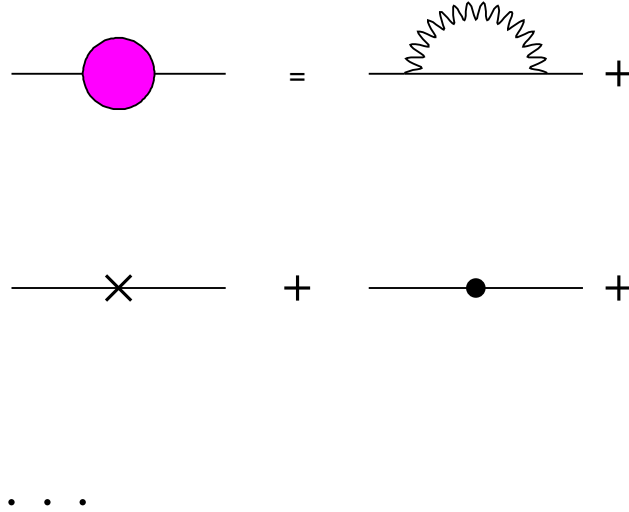

Fig. 10.6 - The second order contributions at the electron propagator.

and the correction is given by

$$e^2\Sigma(p) + B\hat{p} - A = \left(\frac{e^2}{8\pi^2\epsilon} + B\right)\hat{p} - \left(\frac{e^2}{2\pi^2\epsilon}m + A\right) + \text{finite terms.} \quad (10.128)$$

We can now fix the counter terms by choosing

$$B = -\frac{e^2}{8\pi^2} \left(\frac{1}{\epsilon} + F_2\left(\frac{m}{\mu}\right)\right), \quad (10.129)$$

$$A = -\frac{me^2}{2\pi^2} \left(\frac{1}{\epsilon} + F_m\left(\frac{m}{\mu}\right)\right), \quad (10.130)$$

with F_2 and F_m finite for $\epsilon \rightarrow 0$. Notice that these two functions are dimensionless and for the moment being completely arbitrary. However they can be determined by the renormalization conditions, that is by fixing the arbitrary constants appearing in the Lagrangian. In fact, given

$$\begin{aligned} iS_F^{-1}(p) &\equiv \Gamma^{(2)}(p) = \hat{p} - m + B\hat{p} - A + e^2\Sigma(p) \\ &= \left(1 - \frac{e^2}{8\pi^2}F_2\right)\hat{p} - m + \frac{me^2}{2\pi^2}F_m + e^2\Sigma^f, \end{aligned} \quad (10.131)$$

we can require that at the physical pole, $\hat{p} = m$, the propagator coincides with the free propagator

$$S_F(p) \approx \frac{i}{\hat{p} - m}, \quad \text{for } \hat{p} = m. \quad (10.132)$$

From here we get two conditions. The first one is

$$\Gamma^{(2)}(\hat{p} = m) = 0 \quad (10.133)$$

from which

$$e^2 \Sigma^f(\hat{p} = m) - \frac{me^2}{8\pi^2} F_2 + \frac{me^2}{2\pi^2} F_m = 0. \quad (10.134)$$

The second condition is

$$\left. \frac{\partial \Gamma^{(2)}(p)}{\partial p^\mu} \right|_{\hat{p}=m} = \gamma_\mu, \quad (10.135)$$

giving

$$e^2 \left. \frac{\partial \Sigma^f(p)}{\partial p^\mu} \right|_{\hat{p}=m} - \frac{e^2}{8\pi^2} F_2 \gamma_\mu = 0. \quad (10.136)$$

One should be careful because these particular conditions of renormalization give some problem related to the zero mass of the photon. In fact, one finds some ill-defined integral in the infrared region. However these are harmless divergences, and can be eliminated giving a small mass to the photon and sending this mass to zero at the end of the calculations. Notice that these conditions of renormalization have the advantage of being expressed directly in terms of the measured parameters, as the electron mass. However, one could renormalize at an arbitrary mass scale, M . In this case the parameters comparing in \mathcal{L}_p are not the directly measured parameters, but they can be correlated to the actual parameters by evaluating some observable quantity. From this point of view one could avoid the problems mentioned above by choosing a different point of renormalization.

As far as the vacuum polarization is concerned, $\Pi_{\mu\nu}$ gives rise to the following correction to the photon propagator (illustrated in Fig. 10.7)

$$D'_{\mu\nu}(q) = \frac{-ig_{\mu\nu}}{q^2} + \frac{-ig_{\mu\lambda}}{q^2} ie^2 \Pi^{\lambda\rho}(q) \frac{-ig_{\rho\nu}}{q^2} + \dots, \quad (10.137)$$

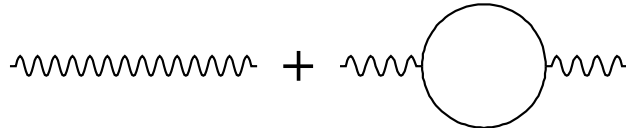

Fig. 10.7 - *The loop expansion for the photon propagator.*

from which

$$\begin{aligned}
D'_{\mu\nu}(q) &= \frac{-ig_{\mu\nu}}{q^2} + \frac{-ig_{\mu\lambda}}{q^2} [(ie^2)(q^\lambda q^\rho - g^{\lambda\rho} q^2)\Pi(q^2)] \frac{-ig_{\rho\nu}}{q^2} + \dots \\
&= \frac{-ig_{\mu\nu}}{q^2} [1 - e^2\Pi(q^2)] - i\frac{q_\mu q_\nu}{q^4} e^2\Pi(q^2) + \dots.
\end{aligned} \tag{10.138}$$

We see that the one loop propagator has a divergent part in $g_{\mu\nu}$, as well in the term proportional to the momenta. Therefore the propagator does not correspond any more to the Lorenz gauge and we need to add to the following terms in \mathcal{L}_p

$$\mathcal{L}_2 = -\frac{1}{4}F_{\mu\nu}F^{\mu\nu} - \frac{1}{2}(\partial_\mu A^\mu)^2, \tag{10.139}$$

the two counterterms

$$\begin{aligned}
(\mathcal{L}_2)_{ct} &= -\frac{C}{4}F_{\mu\nu}F^{\mu\nu} - \frac{E}{2}(\partial_\mu A^\mu)^2 \\
&= -C\left(\frac{1}{4}F_{\mu\nu}F^{\mu\nu} + \frac{1}{2}(\partial_\mu A^\mu)^2\right) - \frac{E-C}{2}(\partial_\mu A^\mu)^2.
\end{aligned} \tag{10.140}$$

As for the electron propagator, we can look at these two contributions as perturbations to the free Lagrangian, and evaluate the corresponding Feynman rules, or evaluate the effect on the propagator. The modification in the equation defining the propagator due to these two terms is

$$[(1+C)q^2 g_{\mu\nu} - (C-E)q_\mu q_\nu]D^{\nu\lambda}(q) = -ig_\mu^\lambda. \tag{10.141}$$

We solve this equation by putting

$$D_{\mu\nu}(q) = \alpha(q^2)g_{\mu\nu} + \beta(q^2)q_\mu q_\nu. \tag{10.142}$$

Substituting in the previous equation we determine α and β . The result is

$$\alpha = -\frac{i}{q^2(1+C)}, \quad \beta = -\frac{i}{q^4} \frac{C-E}{(1+C)(1+E)}. \tag{10.143}$$

The free propagator, including the corrections at the first order in C and E is

$$D_{\mu\nu}(q) = \frac{-ig_{\mu\nu}}{q^2}(1-C) - i\frac{q_\mu q_\nu}{q^4}(C-E) \tag{10.144}$$

and the total propagator

$$D'_{\mu\nu}(q) = \frac{-ig_{\mu\nu}}{q^2}[1 - e^2\Pi(q^2) - C] - i\frac{q_\mu q_\nu}{q^4}[e^2\Pi(q^2) + C - E]. \tag{10.145}$$

We can now choose $E = 0$ and cancel the divergence by the choice

$$C = -\frac{e^2}{6\pi^2\epsilon} + F_3\left(\frac{m}{\mu}\right). \tag{10.146}$$

In fact, we are free to choose the finite term in the gauge fixing, since this choice does not change the physics. This is because the terms proportional to $q_\mu q_\nu$, as it follows from gauge invariance and the consequent conservation of the electromagnetic current, do not contribute to the physical amplitude. For instance, if we have a vertex with a virtual photon (that is a vertex connected to an internal photon line) and two external electrons, the term proportional to $q_\mu q_\nu$ is saturated with

$$\bar{u}(p')\gamma_\mu u(p), \quad q = p' - p. \quad (10.147)$$

The result is zero, by taking into account the Dirac equation. Let us now consider the mass of the photon. We have

$$\begin{aligned} D'_{\mu\nu}(q) &= \frac{-ig_{\mu\nu}}{q^2} [1 - F_3 - e^2\Pi^f] - i\frac{q_\mu q_\nu}{q^4} [F_3 + e^2\Pi^f] \\ &\equiv \frac{-ig_{\mu\nu}}{q^2} [1 - \tilde{\Pi}] - i\frac{q_\mu q_\nu}{q^4} \tilde{\Pi}, \end{aligned} \quad (10.148)$$

where

$$\tilde{\Pi} = e^2\Pi^f + F_3. \quad (10.149)$$

At the second order in the electric charge we can write the propagator in the form

$$D'_{\mu\nu}(q) = \frac{-i}{q^2(1 + \tilde{\Pi}(q))} \left[g_{\mu\nu} + \frac{q_\mu q_\nu}{q^2} \tilde{\Pi}(q) \right] \quad (10.150)$$

and we see that the propagator has a pole at $q^2 = 0$, since $\tilde{\Pi}(q^2)$ is finite for $q^2 \rightarrow 0$. Therefore the photon remains massless after renormalization. This is part of a rather general aspect of renormalization which says that, if the regularization procedure respects the symmetries of the original Lagrangian, the symmetries are preserved at any perturbative order. However, there are cases where it is not possible to devise a regularization procedure such to preserve a given symmetry. This the case of the **anomalous symmetries** which are symmetries only at the classical level but broken by quantum corrections.

Also for the photon we will require that at the physical pole, $q^2 \rightarrow 0$, the propagator has the free form, that is

$$\tilde{\Pi}(0) = 0, \quad (10.151)$$

from which

$$F_3 = -e^2\Pi^f(0). \quad (10.152)$$

10.6 Lamb shift and $g - 2$

In this Section we will use the technology developed in this Chapter to evaluate two important physical quantities. The first one is a contribution to the Lamb shift. The levels $2S_{1/2}$ and $2P_{1/2}$ of the hydrogen atom are degenerate except for corrections

coming from QED. Among these corrections there is one coming from the radiative correction to the photon propagator and this is the one that we will evaluate here. The second quantity that we will evaluate comes from the vertex corrections and it is a contribution to the gyromagnetic factor of the electron which is equal to 2 in the Dirac theory. Let us start with the vacuum polarization.

We will consider the expression (10.149) for small momenta:

$$\tilde{\Pi}(q) \approx e^2 q^2 \frac{d\Pi^f(q)}{dq^2} \Big|_{q^2=0}, \quad (10.153)$$

where use has been made of F_3 being constant. Using the expression for Π^f from the previous Section, we get

$$\Pi^f(q) \approx -\frac{1}{2\pi^2} \left(\frac{\gamma}{6} + \frac{1}{6} \log \left(\frac{m^2}{2\pi\mu^2} \right) \right) + \frac{1}{2\pi^2} \int_0^1 dz z^2 (1-z)^2 \frac{q^2}{m^2} + \dots \quad (10.154)$$

and

$$\tilde{\Pi}(q) \approx \frac{e^2 q^2}{60\pi^2 m^2}. \quad (10.155)$$

It follows

$$D'_{\mu\nu} = -i \frac{g_{\mu\nu}}{q^2} \left[1 - \frac{e^2 q^2}{60\pi^2 m^2} \right] + \text{gauge terms}. \quad (10.156)$$

The first term, $1/q^2$, gives rise to the Coulomb potential, $e^2/4\pi r$. The second gives a correction by a term proportional to a delta function in the real space (we are using the same notations of Section 7.2)

$$\begin{aligned} \Delta_{12} &= e^2 \int_{-\infty}^{+\infty} dt \int \frac{d^4 q}{(2\pi)^4} e^{-iq(x_1 - x_2)} \left[\frac{1}{q^2} - \frac{e^2}{60\pi^2 m^2} \right] \\ &= -\frac{e^2}{4\pi r} - \frac{e^4}{60\pi^2 m^2} \delta^3(\vec{r}). \end{aligned} \quad (10.157)$$

This modification of the Coulomb potential changes the energy levels of the hydrogen atom, and it is one of the contributions to the Lamb shift, which produces a splitting of the levels $2S_{1/2}$ and $2P_{1/2}$. The total Lamb shift is the sum of all the self-energy and vertex corrections, and turns out to be about 1057.9 MHz. The contribution we have just evaluated is only -27.1 MHz, but it is important since the agreement between experiment and theory is at the level of 0.1 MHz.

We have now to discuss the vertex corrections. We have seen that the divergent contribution is $\Lambda_\mu^{(1)}(p', p)$, and this is proportional to γ_μ . The counter term to add to the interacting part of \mathcal{L}_p ,

$$\mathcal{L}_p^{\text{int}} = -e \bar{\psi} \gamma_\mu \psi A^\mu, \quad (10.158)$$

is

$$(\mathcal{L}_3)_{\text{ct}} = -e D \bar{\psi} \gamma_\mu \psi A^\mu. \quad (10.159)$$

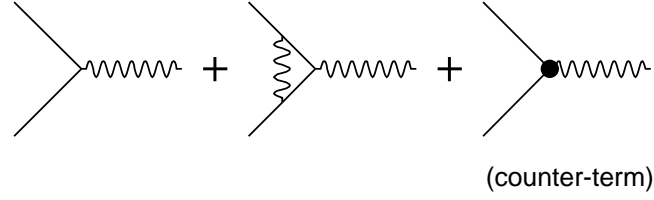

Fig. 10.8 - *The one loop vertex corrections.*

The complete vertex (omitting the factor $-ie$) is given by (see Fig. 10.8)

$$\Lambda_\mu^T = \gamma_\mu(1 + D) + e^2\Lambda^\mu. \quad (10.160)$$

Due to the conservation of the electromagnetic current, it is possible to prove the validity of the Ward-Takahashi identity between the total self-energy and the total vertex correction

$$\frac{\partial \Sigma^T(p)}{\partial p} = \Lambda_\mu^T(p, p), \quad (10.161)$$

where Σ^T and Λ_μ^T are defined as

$$\Gamma^{(2)} = \hat{p} - m + \Sigma^T, \quad \Gamma_\mu = \gamma_\mu + \Lambda_\mu^T. \quad (10.162)$$

This identity applied to the expressions (10.131) and (10.160) gives

$$B\gamma_\mu + e^2 \frac{\partial \Sigma(p)}{\partial p^\mu} = D\gamma_\mu + e^2\Lambda_\mu(p, p), \quad (10.163)$$

where Σ and Λ are the self-energy and vertex corrections evaluated from the Feynman diagrams associated to \mathcal{L}_p . One can check that the Ward-Takahashi identity holds for the the regularized one-loop expressions for Σ and Λ^μ in equations (10.73) and (10.103), and therefore it must be satisfied order by order in the ϵ expansion. Using this result one gets

$$B = D, \quad (10.164)$$

at this order in perturbation theory. This equality is certainly satisfied by the divergent parts of these counterterms, since they are devised in order to eliminate the terms in $1/\epsilon$ in Σ and Λ_μ which are equal (see eqs. (10.119) and 10.121)). However, in order to satisfy (10.164) also the finite parts of B and D should be equal. As a consequence we fix the counter term D by

$$D = -\frac{e^2}{8\pi^2} \left[\frac{1}{\epsilon} + F_2 \right], \quad (10.165)$$

with F_2 the same as in eq. (10.136). Notice that in this way the wave function renormalization terms Z_1 and Z_2 are made equal, and the charge renormalization depends only on Z_3 , that is from the vacuum polarization.

The complete one-loop vertex is then

$$\Lambda_\mu^T = \left[\gamma_\mu + e^2 \left(\Lambda_\mu^f - \frac{F_2}{8\pi^2} \gamma_\mu \right) \right]. \quad (10.166)$$

By using again the Ward-Takahashi identity for the regularized expressions, valid at any order in $1/\epsilon$ and, therefore, also for the finite parts, and the condition (10.136)

$$\Lambda_\mu^f \Big|_{\hat{p}=m} = \frac{\partial \Sigma^f}{\partial p^\mu} \Big|_{\hat{p}=m} = \frac{F_2}{8\pi^2} \gamma_\mu, \quad (10.167)$$

we see that for spinors on shell we have

$$\bar{u}(p) \Lambda_\mu^T u(p) \Big|_{\hat{p}=m} = \bar{u}(p) \gamma_\mu u(p). \quad (10.168)$$

It is interesting to notice that we have been able to satisfy the Ward-Takahashi identity since we had the freedom to choose the finite part of the counterterm D . There are situations where this is not possible and this is the case of the **anomalies**, that is transformations that are symmetries at the classical level but that are broken at quantum level. A celebrated example is the one of the axial-vector anomaly. The lagrangian for a massless Dirac field is invariant under the chiral transformation

$$\psi(x) \rightarrow e^{i\alpha\gamma_5} \psi(x), \quad (10.169)$$

at the classical level, besides being invariant under a phase transformation. Both symmetries are preserved by making the Dirac field to interact with the electromagnetic field. However, it turns out that it is impossible to define a renormalization procedure (choice of the counterterms) in order to satisfy both the Ward-Takahashi identities following from the conservations of the two currents associated to the two symmetries. Usually one makes the choice of satisfying the Ward-Takahashi identity associated to the phase symmetry and the chiral symmetry is broken at the quantum level (axial anomaly).

We will now evaluate the radiative corrections to the $g-2$ of the electron. Here g is the gyromagnetic ratio, which is predicted to be equal to 2 by the Dirac equation (see Section 4.6). To this end we first need to prove the Gordon identity for the current of a Dirac particle

$$\bar{u}(p') \gamma_\mu u(p) = \bar{u}(p') \left[\frac{p^\mu + p'^\mu}{2m} + \frac{i}{2m} \sigma_{\mu\nu} q^\nu \right] u(p), \quad (10.170)$$

with $q = p' - p$. For the proof we start from

$$\hat{p} \gamma_\mu u(p) = (-m \gamma_\mu + 2p_\mu) u(p) \quad (10.171)$$

and

$$\gamma_\mu \hat{p} u(p) = m \gamma_\mu u(p). \quad (10.172)$$

Subtracting these two expressions we obtain

$$\gamma_\mu u(p) = \left(\frac{p_\mu}{m} - \frac{i}{m} \sigma_{\mu\nu} p^\nu \right) u(p). \quad (10.173)$$

An analogous operation on the barred spinor leads to the result. We observe also that the Gordon identity shows immediately that the value of the gyromagnetic ratio is 2, because it implies that the coupling with the electromagnetic field is just

$$\frac{e}{2m} \sigma_{\mu\nu} F^{\mu\nu}(q). \quad (10.174)$$

To evaluate the correction to this term from the one loop diagrams, it is enough to evaluate the matrix element

$$e^2 \bar{u}(p') \Lambda_\mu^{(2)}(p', p) u(p) \quad (10.175)$$

in the limit $p' \rightarrow p$ and for on-shell momenta. In fact $\Lambda_\mu^{(1)}$ contributes only to the terms in γ_μ and, in the previous limit, they have to build up the free vertex, as implied by the renormalization condition. Therefore we will ignore all the terms proportional to γ_μ and we will take the first order in the momentum q . For momenta on shell, the denominator of $\Lambda_\mu^{(2)}$ is given by

$$[\dots] = m^2(x+y) - m^2x(1-x) - m^2y(1-y) + 2m^2xy = m^2(x+y)^2. \quad (10.176)$$

In order to evaluate the numerator, let us define

$$V_\mu = \bar{u}(p') \gamma^\alpha [\hat{p}'(1-y) - \hat{p}x + m] \gamma^\mu [\hat{p}(1-x) - \hat{p}'y + m] \gamma_\alpha u(p). \quad (10.177)$$

Using $\hat{p}\gamma_\alpha = -\gamma_\alpha\hat{p} + 2p_\alpha$, and an analogous equation for \hat{p}' , we can bring \hat{p} to act on the spinor to the right of the expression, and \hat{p}' on the spinor to the left, obtaining

$$\begin{aligned} V_\mu &= \bar{u}(p') \left[my\gamma^\alpha + 2(1-y)p'^\alpha - \gamma^\alpha\hat{p}x \right] \gamma^\mu \\ &\quad \times [mx\gamma_\alpha + 2(1-x)p_\alpha - \hat{p}'y\gamma_\alpha] u(p). \end{aligned} \quad (10.178)$$

Making use of

$$\gamma_\alpha \gamma^\mu \gamma_\alpha = -2\gamma^\mu, \quad (10.179)$$

$$\gamma_\alpha \gamma_\mu \gamma_\nu \gamma^\alpha = 4g_{\mu\nu}, \quad (10.180)$$

$$\gamma_\alpha \hat{p} \gamma^\mu \hat{p}' \gamma^\alpha = -2\hat{p}' \gamma^\mu \hat{p}, \quad (10.181)$$

we get

$$\begin{aligned} V_\mu &= \bar{u}(p') \left[-2m^2xy\gamma^\mu + 2my(1-x)(-m\gamma^\mu + 2p^\mu) \right. \\ &\quad -4my^2p'^\mu + 2mx(1-y)(-m\gamma^\mu + 2p'^\mu) + 4(1-x)(1-y)m^2\gamma^\mu \\ &\quad -2y(1-y)m^2\gamma^\mu - 4mx^2p^\mu \\ &\quad \left. -2m^2x(1-x)\gamma^\mu - 2xym^2\gamma^\mu \right] u(p) \end{aligned} \quad (10.182)$$

and for the piece which does not contain γ_μ

$$V_\mu = 4m\bar{u}(p') \left[p^\mu(y - xy - x^2) + p'^\mu(x - xy - y^2) \right] u(p). \quad (10.183)$$

Therefore the relevant part of the vertex contribution is

$$\begin{aligned} e^2\bar{u}(p')\Lambda_\mu^{(2)}(p', p)u(p) &\rightarrow -\frac{e^2}{16\pi^2} \int_0^1 dx \int_0^{1-x} dy \frac{4}{m}\bar{u}(p') \left[p^\mu \frac{(y - xy - x^2)}{(x+y)^2} \right. \\ &\quad \left. + p'^\mu \frac{(x - xy - y^2)}{(x+y)^2} \right] u(p). \end{aligned} \quad (10.184)$$

By changing variable, $z = x + y$, we obtain

$$\begin{aligned} &\int_0^1 dx \int_0^{1-x} dy \frac{y - xy - x^2}{(x+y)^2} = \int_0^1 dx \int_x^1 dz \left[\frac{1-x}{z} - \frac{x}{z^2} \right] \\ &= \int_0^1 [-(1-x)\log x + x - 1] \\ &= \left[-x \log x + x + \frac{x^2}{2} \log x - \frac{x^2}{4} + \frac{x^2}{2} - x \right]_0^1 = \frac{1}{4}, \end{aligned} \quad (10.185)$$

from which

$$e^2\bar{u}(p')\Lambda_\mu^{(2)}(p', p)u(p) \rightarrow -\frac{e^2}{16\pi^2 m} \bar{u}(p') [p_\mu + p'_\mu] u(p). \quad (10.186)$$

Using the Gordon identity in this expression, and eliminating the further contribution in γ_μ , we obtain the correction to the magnetic moment

$$e^2\bar{u}(p')\Lambda_\mu^{(2)}(p', p)u(p)|_{\text{magn. mom.}} \rightarrow \frac{ie^2}{16\pi^2 m} \bar{u}(p') \sigma_{\mu\nu} q^\nu u(p). \quad (10.187)$$

Finally we have to add this correction to the vertex part taken at $p' = p$, which coincides with the free vertex

$$\begin{aligned} &\bar{u}(p') \left[\gamma_\mu + \frac{ie^2}{16\pi^2 m} \sigma_{\mu\nu} q^\nu \right] u(p) \Big|_{p' \approx p} \\ &\approx \bar{u}(p') \left[\frac{p_\mu + p'_\mu}{2m} + \frac{i}{2m} \left(1 + \frac{e^2}{8\pi^2} \right) \sigma_{\mu\nu} q^\nu \right] u(p). \end{aligned} \quad (10.188)$$

Therefore the correction is

$$\frac{e}{2m} \rightarrow \frac{e}{2m} \left(1 + \frac{\alpha}{2\pi} \right). \quad (10.189)$$

Recalling that g is the ratio between $\vec{S} \cdot \vec{B}$ and $e/2m$, we get

$$\frac{g}{2} = 1 + \frac{\alpha}{2\pi} + \mathcal{O}(\alpha^2). \quad (10.190)$$

This correction was evaluated by Schwinger in 1948. Actually we know the first three terms of the expansion

$$\begin{aligned} a_{\text{th}} &= \frac{1}{2}(g - 2) = \frac{1}{2} \frac{\alpha}{\pi} - 0.32848 \left(\frac{\alpha}{\pi} \right)^2 + 1.49 \left(\frac{\alpha}{\pi} \right)^3 + \dots \\ &= (1159652.4 \pm 0.4) \times 10^{-9}, \end{aligned} \tag{10.191}$$

to be compared with the experimental value

$$a_{\text{exp}} = (1159652.4 \pm 0.2) \times 10^{-9}. \tag{10.192}$$